



# Model 1200 REMOTE TEST<sup>®</sup>

## Remote Operated TEST<sub>AND</sub>DRAIN<sup>®</sup> Valve

### Remote System Inspection with Fail Safe Integrity

**How the REMOTE TEST<sup>®</sup> Works:** Energizing the solenoid allows system water to flow through a test orifice. After the preset time delay, the water flow alarm is activated, confirming system integrity. No response from the system alarms indicates potential system problems, such as: No water flowing in the system, an operable water flow alarm, or other system problems that may require site investigation. The REMOTE TEST<sup>®</sup> is designed to be integrated into an existing panel or wired to an independent panel allowing ONE PERSON to activate each specific system or group of systems from one central location.

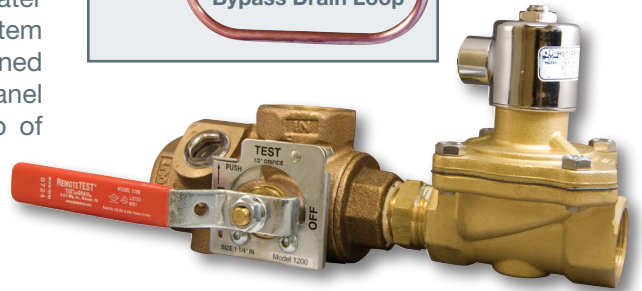
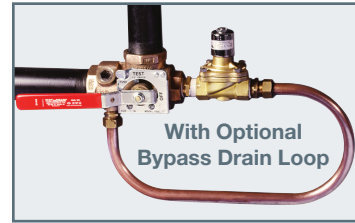

- Allows system tests to be performed easily during off-peak hours
- Ability to test each floor individually is unaffected
- Available in 24V DC or 120V AC
- Wiring does not require a supervised circuit
- Complies with NFPA 13, 2007 Edition, Chapters 8.16.2.4.1 - 8.16.2.4.4, A.8.17.4.2, 8.17.4.2.2, 8.17.4.2.4, 8.17.4.3.1, and 8.17.3.2
- Repair Kits available

Sizes:

3/4"	1"	1 1/4"	1 1/2"	2"
------	----	--------	--------	----

### Model 1200 - Plan View

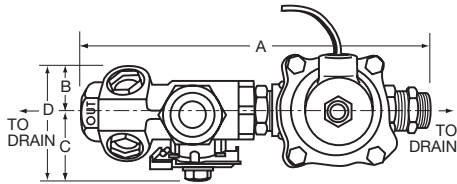

### Model 1200 - Front View

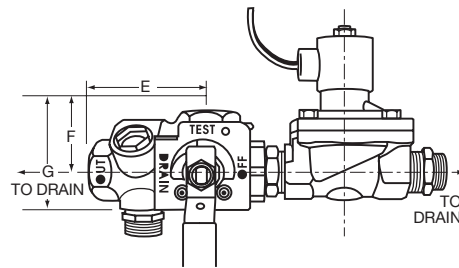

### With Optional Bypass Drain

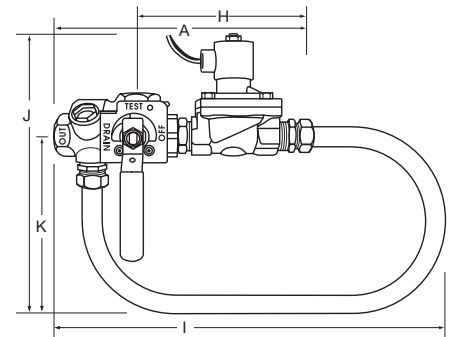

### Dimensions

Orifice Size Available: 3/8", 7/16", 1/2", 17/32", ELO (5/8"), ESFR (3/4")\*, K25\*\*

SIZE	A	B	C	D	E	F	G	H	I†	J†	K†
1"	9 1/2" (241 mm)	1 3/4" (45 mm)	2 1/4" (57 mm)	4" (102 mm)	3 1/4" (83 mm)	1 3/4" (45 mm)	6 1/2" (165 mm)	6 1/4" (159 mm)	18 1/2" (470 mm)	12 3/4" (324 mm)	8 3/4" (222 mm)
1 1/4"	10" (254 mm)	1 3/4" (45 mm)	3" (72 mm)	4 3/4" (121 mm)	3 1/4" (83 mm)	1 3/4" (45 mm)	7 1/4" (184 mm)	6 1/2" (165 mm)	18 1/2" (470 mm)	12 3/4" (324 mm)	8 3/4" (222 mm)
1 1/2"	11" (279 mm)	1 3/4" (45 mm)	3 3/4" (95 mm)	5 1/2" (140 mm)	4" (102 mm)	2 3/4" (70 mm)	11" (279 mm)	7 1/4" (184 mm)	18 1/2" (470 mm)	12 3/4" (324 mm)	8 3/4" (222 mm)
2"	11" (279 mm)	1 3/4" (45 mm)	3 3/4" (95 mm)	5 1/2" (140 mm)	4" (102 mm)	2 3/4" (70 mm)	11" (279 mm)	7 1/4" (184 mm)	18 1/2" (470 mm)	12 3/4" (324 mm)	8 3/4" (222 mm)

\*Available on 1 1/4" to 2" size units only \*\*Available on 2" size units only †Refers to optional Bypass Drain Loop

**Reliability, Versatility, Code Compatibility**



# Model 1200 REMOTE TEST®

## 300 PSI Bronze Ball Valve with Solenoid for Remote Operation

### General Notes

1. The RemoteTEST Model 1200 is designed to provide remote functional testing of sprinkler waterflow alarm devices and confirm system viability.
2. The RemoteTEST Model 1200 is considered an auxiliary testing device and, as stipulated in NFPA 72, "the wiring does not require a supervised circuit". Installation shall be in strict conformance with the National Electrical Code (NFPA 70), NFPA 13 and 72, and/or authority having jurisdiction.

### Sequence of Operation

1. Notify the central monitoring station or appropriate authority prior to testing the system.
2. The RemoteTEST Model 1200 is activated by a control panel supplying power to the normally closed solenoid of the RemoteTEST®.
3. Once energized, the solenoid of the RemoteTEST® opens which flows system water through an orifice. This moves water past the water flow alarm devices and simulates the flow to the sprinkler system. The system will then perform all the output functions associated with an alarm event, such as activating the notification appliances (horn, strobes, etc.).
4. The activation switch can then be returned to the normal position. This will de-energize the RemoteTEST®, shut the valve, and stop the flow of system water.
5. The fire panel can then be acknowledged and reset. The system is now ready to test the next water flow alarm device.
6. The ability to manually operate each TESTANDRAIN® valve of the RemoteTEST® to activate each water flow alarm device is unaffected.
7. Once testing has been completed, restore the fire alarm panel and notify the appropriate authority.

### Model 1200 Valve Operating Instructions

#### To Manual Test:

1. Turn valve handle counterclockwise from "Off" to "Test". The handle will stop automatically.
2. After test is completed return handle to "Off"

#### To Remote Test:

3. Activate panel controls to open the solenoid of the RemoteTEST® to start test.
4. Release panel controls to close the solenoid of the RemoteTEST® after test is completed.

#### To Drain:

1. Turn valve handle counterclockwise from "Off" to "Test". The handle will stop automatically.
2. Depress "Push" button and turn handle to "Drain".
3. When system is empty return handle clockwise to "Off" position.

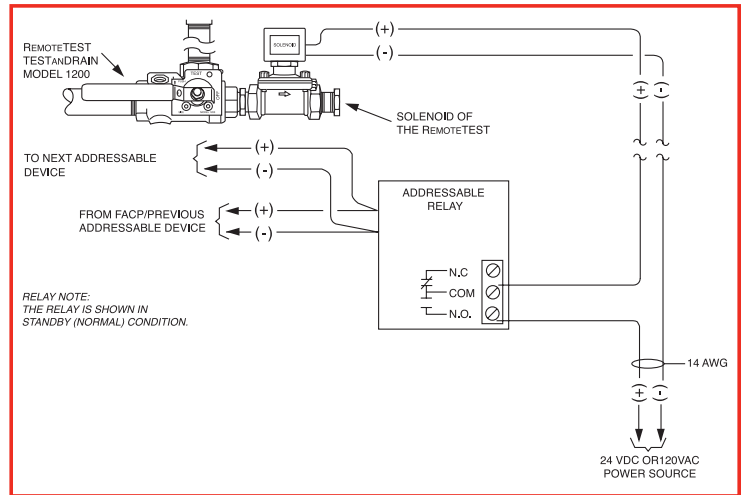
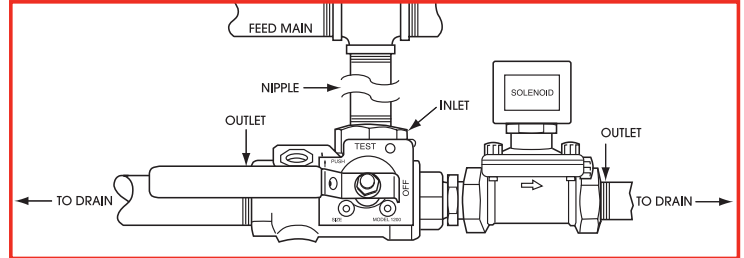

### Installation Instructions for AGF Model 1200 RemoteTEST®

1. Check the indicating plate for the correct orifice size. TESTANDRAIN® orifices available include 3/8", 7/16", 1/2", 17/32", 5/8", (ELO) and 3/4", (ESFR).
2. Thread pipe nipple into the inlet of the TESTANDRAIN®.
3. Thread pipe nipple and the TESTANDRAIN® into the outlet of the feed main.
4. Thread piping from outlet of TESTANDRAIN® and outlet of the solenoid of the RemoteTEST® to an acceptable drain.
5. Wire in accordance with applicable local and national electrical codes. Loosen the hex nut of the solenoid to rotate the coil jacket to desired position to accommodate conduit location. Using a torque wrench, tighten the hex nut to 20-25 inch pounds when installation is complete.



## USA Patent # 4741361 and Other Patents Pending



**AGF Manufacturing Inc.**  
 100 Quaker Lane, Malvern, PA 19355  
 Phone: 610-240-4900  
 Fax: 610-240-4906  
 www.testandrain.com

Job Name: \_\_\_\_\_  
 Architect: \_\_\_\_\_  
 Engineer: \_\_\_\_\_  
 Contractor: \_\_\_\_\_