

Water



Safety

**Water Safety, Flow Control and
Backflow Prevention Products
Condensed Catalog**

watts.com

WATTS®

Index

Model/Series - - - - -	Page	Model/Series - - - - -	Page	Model/Series - - - - -	Page	Model/Series - - - - -	Page	
Numerical								
1L/1XL	24	777	86	DuoVent	101	NF8	62	
2-M2	116	777C-M1	89	DWB	115	OTV	109	
3L	27	800M4FR/800M4QT	62	E-50	30	P3	102	
05	114	800MQT	62	E-75	31	P60	18	
6	80	806-1	84	E-100	30	P777-100	88	
007	43	909	53-54	E-120	31	PG	92	
007DCDA	49	909RPDA	59	Elbows	58	PIPF	103	
7	63	911	96	EMVI-6400SS	71	PLT	37	
008PCQT	62	912HP	61	ENS-20	29	PVS-1000	38	
8	64	919	56	ET	97	PX, P1-P16	121	
009	55	957/957N/957Z	50	ETA	97	QF	104	
9BD/9D/9DS	61	957RPDA/957NRPDA/957ZRPDA	57	ET-ASF	99	R-24, R-26, R-30	29	
10L	24	994	51	ET-RA	97	RA	106	
15	114	994BLT/994HMB	52	ETX, ETSX	98	RK-SAE-TC/RK-TC 1/8	58	
17	87	994RPDA	58	F127W	14	RK-W STD	67	
25AUB-Z3	5	1000	121	FBV	74	RL600	122	
26A	17	1156F	96	FBV-PEX	77	RPV	100	
27	87	1170-M2/L1170-M2	112	FBV-3C/FBVS-3C	76	S8/S8C	62	
30/30L	27	1250	121	FBV-3C-QC	76	SAE-TC/SAE-TC Adapter	60	
40L/40XL	25, 26	1450F	96	FBV-3-Press	77	SAE-TC Brass Cap	60	
53L	27	1500	121	FBV-3-SS/FBVS-3-SS	76	SAN50	108	
70A	113	2000	121	FBV-4/FBVS-4	77	SAN89	108	
77F-BI	87	2000-M5	104	FH/FHB	118	SC, SC8	119	
77F-CSI	88	2300	15	Fig. 31/41/41A	22, 23	SD-2	65	
77F-CSSI	89	3000 - 3200	123, 124	FR 500	67	SD-3	65	
77F-DI-125/77F-DI-250	86	5300A	28	FS10-C	107	S-FBV-1	78	
77F-DI-FDA-125	86	Alphabetical			FS10-F	107	SilverEagle TC	58
77F-SS/77G-SS	89	A2C-M1	115	FS-20	107	SS	120	
77S	86	A200	117	FS-26, FS-36	30	SS07F	67	
87SI	88	ACV	16	FS-CDC-S	125	ST375 - ST2000	121	
88CSI	88	Air Gaps	60	FS-CFC-S	125	STD-CA	122	
88S	89	Anti-Scale Systems	136	FS-CIC-S	125	SV/SVA/SVS	106	
97FB-CI	90	APU	116	FS-CTC-S	126	SW/SWS/SWT/SWC	120	
97FB-CSSI	90	AS-20, 22, 26, 30	29	FS-CWM-S	126	T145B	96	
97FB-FSFE	90	AS/AS-T	101	FV-4M1	102	T156B	96	
97FD-CI	90	AS-B	101	G/GH	104	TA	134	
100DT/100DT-A	35	B-24, B-26, B-30, B-36	29	G-4000M/G-4000-M1	79	TB	133	
100XL	24	B6000/B6001	69	GBF-H, GBF-G	93	TBC	134	
110/113/114/115/116/118/127(ACV)	16	B6000-CC/B6001-CC	74	GBV	79	TBP	134	
123LP	15	B6002	72	GBV-1	79	TBR	133	
127	19	B6004	73	Gov. 80-M1	64	Test Cocks	60	
127W	14	B6010/B6011	73	G-TB, G-TBR	135	TDV	92	
140	25, 26	B6013	73	GV/GVS/GLV	83	TK-7	66	
142/144	108	B6080/B6081	70	H32	27	TK-9A	66	
150A	114	B6300/B6301	72	H560	17	TK-99D	66	
152A/152SS	18	B6400	73	HAV	102	TK-99E	66	
174A	20	B6400SE	73	HBV	109	TK-DL	66	
188A	63	B6780/B6781	72	HP	99	TL	135	
210-5	24	B6800/B6801	74	* HPX	99	TP	135	
215	18	Ball Valve Options	75	HWA	109	TR	67	
223/223S	13	BD	117	HY-42	118	TSE-75	30	
252A	18	BD-QT	118	ICV-125-2-2-T	80	TWH	33	
263A	17	BF	94, 95	ICVF-125	81	TWS	65	
276H300	18	BIC-1000	38	ICWV-125	81	U5B-Z3	4	
288A	61	BP30	28	IPF-T-M1/IPF-S-M1	103	UL	109	
289	61	* BRV	35	IR-56	17	* USG-B	110	
315	22	C1/4TF	122	IT6300/IS6301	75	* USG-P	110	
340/342	25, 26	C-36	29	IWTG	18	WAMV	120	
374A	20	C-FBV-1	78	IWTG-Gas	132	WAS	120	
375	121	CDC-S	127	IWTG-HTX	132	Watts Rock	66	
403RT-RW	82	CFC-P	127	IWTG-NYC	132	WB-Watts Box	66	
405/406	82	CFC-S	127	Jumper Kits	12	WBV-3/WBVS-3	78	
408-OSY-RW	82	CIC-P	128	KA2	115	WBVC	78	
411	83	CSM-61	91	L111	111	WCV	84	
415	21	CSM-81	91	M1/4TF	122	WDS	32	
500	121	CSM-91	91	MG/MGH	104	W-FLG	68	
530C	17	CTC-P	128	MMV-M1	111	WFT	105	
560	27	CTC-S	128	N9/N9C/N9-CD/NLF9	59	WFTC/WFTK	106	
600/601S	80	Cu7	63	N30/N30L	27	WGV	83	
709	42	CV/CVS/CVY/CVYS	85	N36	34	WGVS-1, WGVC	84	
709DCDA	48	CWH-S	37, 129	N45B, N45B-M1	6-7	WIB	105	
719	44	CWM-S	129	N45B-EZ-M1, N45BDU-EZ	8-9	WM-26/WM-30	30	
740	21	CX, C4-C12	121	N50	107	WPE-24	30	
745	87	DBF	94	N55B, N55B-M1	10-11	W-SPL	68	
750	121	DETA	36	N170	113	WTD-600	106	
757/757N	39	DET-M1	36	N223B/N223BS	14	WWS	67	
757a/757Na	40	DPG1	130	N223F/N223FS	14			
757aDCDA/757NaDCDA	46	DPG3	130	N240X/N241X	26, 27			
757DCDA/757NDCDA	45	DPG5	131	N250	15			
774	41	DPS-20	29	N360, N3601	34			
774DCDA	47	DPTG1/DPTG3	131	N388	61			

* New items or sizes added.

Watts Regulator Company

Since 1874 Watts Regulator Company has been a leader in valve technology, offering a wide variety of products for applications in the commercial, fire protection, heating & hydronics, irrigation, residential, steam and waterworks markets. As you will see by looking through our general catalog, Watts has truly become the single source for plumbing & heating and water quality products. Why not make Watts your single source for quality plumbing products?

Table of Contents

Section 1	Pressure Regulators & Automatic Control Valves	4 – 19
Section 2	Relief Valves	20 – 28
Section 3	Water Heater Installation Products (Drain Lines, Expansion Tanks, Water Heater Stands, Straps and Enclosures)	29 – 35
Section 4	Backflow Preventers & Accessories	36 – 66
Section 5	Ball Valves	67 – 77
Section 6	Gate / Globe / Check Valves	78 – 85
Section 7	Strainers	86 – 90
Section 8	Balancing & Flow Measurement	91 – 92
Section 9	Butterfly Valves	93 – 95
Section 10	Hydronics / Steam Heating Products	96 – 109
Section 11	Tempering Valves	110 – 113
Section 12	Plumbing Specialties (Wall Hydrants, Water Hammer Arrestors, Float Valves, Evaporative Cooler Kits, Trap Primers)	114 – 122
Section 13	Dielectric Unions	123 – 124
Section 14	Flexible Connectors	125 – 129
Section 15	Gauges	130 – 135
Section 16	Anti-Scale Systems	130 – 135

Series U5B-Z3 (1/2" - 2")

High Performance Water Pressure Reducing Valves

- Provides water pressure control solutions for residential, commercial, and industrial applications
- Basic design and construction is time tested and proven
- Offers durability and years of continuous trouble-free operation
- Water savings up to 30%^A (see page 12)

Specifications

- Temperature Range: 33°F – 160°F (0.5°C – 71°C)
- Maximum Working Pressure: 300psi (20.7 bar)
- Adjustable Reduced Pressure Range: 25 – 75psi (172 – 517kPa)
- Standard Reduced Pressure Setting: 50psi (345kPa)

Standards

Meets requirements of ASSE Standard 1003, (ANSI A112.26.2), CSA Standard B356, Southern Standard Plumbing Code and listed by IAPMO.



Models

U5B-Z3 – NPT threaded female union inlet x NPT female outlet w/built in thermal expansion bypass

U5B-S-Z3 – Solder Union inlet x NPT female outlet w/built in thermal expansion bypass

U5B-QC-Z3 – Single Union - Quick-Connect inlet end

5M3-Z6 – Water meter threaded connections and 7 1/2" (190mm) lay length for new or existing meter box installations. For 5/8" (16mm), 5/8" x 3/4" (16 x 20mm) or 3/4" (20mm) meter setters or resetters

Options

add Suffix:

- G Gauge tapping
- GG Gauge tapping and 160psi (11.0 bar) gauge
- HP High pressure range 75 – 100psi (5.2 – 6.9 bar)
- LP Low pressure range 10 – 35psi (69 – 241 kPa)

For additional information, request literature ES-U5

*Bypass will not work if inlet pressure is above 150psi (10.3 bar)



U5B-Z3

Features

- Standard construction includes Z3 sealed epoxy coated spring cage and corrosion resistant adjusting and cage screws for accessible outdoor or pit installations
- Integral stainless steel strainer
- Replaceable seat module
- Bronze body construction
- Serviceable in line
- Bypass feature controls thermal expansion pressure (U5B)*
- High temperature resistant reinforced diaphragm for hot water

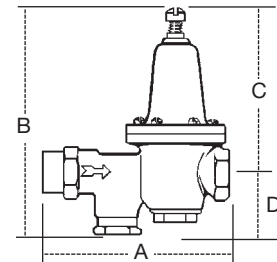

MODEL †	SIZE (DN)		DIMENSIONS (APPROX.)								WEIGHT	
	in.	mm	A		B		C		D		lbs.	kgs.
U5B-Z3	1/2	15	5 5/8	143	5 7/8	149	4 1/4	108	1 5/8	41	4	1.8
U5B-Z3	3/4	20	6 3/16	157	6 7/8	175	5	127	1 7/8	48	5	2.3
U5B-Z3	1	25	6 5/8	168	7 3/8	187	5 3/8	137	2	50	6	2.7
U5B-Z3	1 1/4	32	7 15/16	191	8 3/8	213	6 1/8	155	2 1/4	57	9	4.0
U5B-Z3	1 1/2	40	9 7/16	240	9 3/8	238	6 1/2	165	2 7/8	73	14	6.3
U5B-Z3	2	50	10 7/8	276	12 1/4	311	9	229	3 1/4	83	23	10.4

† Dimensions for all models are shown on literature ES-U5.

Series 25AUB-Z3 (1/2" – 2")

Standard Capacity Water Pressure Reducing Valves

- Accurate water pressure control
- Bronze body construction
- Fast and easy adjustment
- Popular choice for residential and commercial applications
- Water Savings up to 30%^Δ (see page 12)



25AUB-Z3

Specifications

- Temperature Range: 33°F - 160°F (0.5°C - 71°C)
- Maximum Working Pressure: 300psi (20.7 bar)
- Adjustable Reduced Pressure Range: 25-75psi (172 - 517kPa)
- Standard Reduced Pressure Setting: 50psi (345kPa)

Standards

Meets requirements of ASSE Standard 1003 (ANSI A112.26.2), CSA Standard B356, Southern Standard Plumbing Code and Listed by IAPMO.



Models

- 25AUB-Z3** – NPT threaded female union inlet x NPT female outlet
- 25AUB-S-Z3** – Solder Union inlet x NPT female outlet
- 25AUB-QC-Z3** – Single Union – Quick-Connect union inlet
- 25AUB-DU-Z3** – Double Union – NPT threaded union female inlet and outlet
- 25AUB-S-DU-Z3** – Double Union – Solder union inlet and outlet
- 25AUB-DU-THDxPEX-Z3** – Double Union – NPT threaded female union inlet and PEX union outlet
- 25AUB-DU-CPVC-Z3** – Double Union – CPVC union inlet and outlet
- 25AUB-DU-LF-Z3** – Double Union body less union fittings
- 25AUB-DU-QC-Z3** – Double Union – Quick-Connect union inlet and outlet

Options

add Suffix:

- G Gauge tapping 1/8"
- GG Gauge tapping and 160psi (11.0 bar) gauge
- HP High pressure range 75-125psi (5.2 – 8.6 bar)
- LP Low pressure range 10-35psi (69 – 241 kPa)
- Z7 400psi (27.6 bar) initial pressure, 1/2" (20mm) models only

add Prefix:

- LF Lead Free* construction

For additional information, request literature ES-25AUB.

***The combined metal components of this product contacted by potable water contain less than one half of one percent (0.5%) of lead by weight.**

**Bypass will not work if inlet pressure is above 150psi (10.3 bar)

Features

- Union inlet connection
- Integral stainless steel strainer
- Replaceable seat module
- Bronze body construction
- Serviceable in line
- Bypass feature controls thermal expansion pressure**
- High temperature resistant reinforced diaphragm for hot water
- Standard construction includes Z3 sealed epoxy coated spring cage and corrosion resistant adjusting & cage screws for accessible outdoor or pit installations

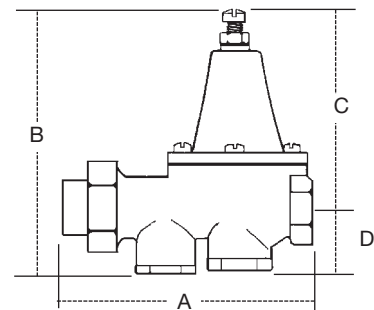

MODEL †	SIZE (DN)		DIMENSIONS (APPROX.)								WEIGHT	
	in.	mm	A		B		C		D		lbs.	kgs.
25AUB-Z3	1/2	15	5 3/8	137	7	178	5 1/2	140	1 1/2	38	3.5	1.6
25AUB-Z3	3/4	20	5 9/16	135	7	178	5 1/2	140	1 1/2	38	3.5	1.6
25AUB-Z3	1	25	6	152	8	203	6 1/4	159	1 3/4	44	6.5	2.9
25AUB-Z3	1 1/4	32	8 3/4	222	9	229	6 7/8	175	2 1/8	54	10.0	4.5
25AUB-Z3	1 1/2	40	8 3/4	222	9 1/2	241	7 1/8	181	2 3/8	60	10.0	4.5
25AUB-Z3	2	50	9 3/4	235	11 1/4	286	8	203	3 1/4	83	15.0	6.8

† Dimensions for all models are shown on literature ES-25AUB.

Series N45B-M1 (1/2" – 1")

Water Pressure Reducing Valves

- Bronze body construction
- Ideal for residential and commercial applications
- Integral stainless steel strainer and built-in bypass
- Water savings up to 30%^Δ (see page 12)

Specifications

- Temperature Range: 33°F – 180°F (0.5°C - 82°C)
- Maximum Working Pressure: 400psi (27.6 bar)
- Adjustable Reduced Pressure Range: 25 – 75psi (172 – 517 kPa)
- Standard Reduced Pressure Setting: 50psi (345 kPa).

Standards

Meets requirements of ASSE Standard 1003 (ANSI A112.26.2) and CSA Standard B356. Certified by NSF to ANSI/NSF Standard 61-8 (LF N45B-M1 Models only). Listed by IAPMO, City of Los Angeles.



Models

- N45B-M1** – NPT threaded female inlet x NPT female outlet
- N45BU-M1** – NPT threaded union inlet x NPT female outlet
- N45BU-S-M1** – Solder Union inlet x NPT female outlet
- N45BU-QC-M1** – Single Union – Quick-Connect union inlet
- N45BDU-M1** – Double Union – NPT threaded union female inlet and outlet
- N45BDU-S-M1** – Double Union – Solder union inlet and outlet
- N45BDU-PEX-M1** – Double Union – PEX union inlet and outlet
- N45BDU-CPVC-M1** – Double Union – CPVC union inlet and outlet
- N45BDU-QC-M1** – Double Union – Quick-Connect union inlet and outlet

Options

add Suffix:

- G Gauge tapping
- GG Gauge tapping and 160psi (11.0 bar) gauge

add Prefix:

- LF Lead Free* construction

For additional information, request literature ES-N45B

***The combined metal components of this product contacted by potable water contain less than one half of one percent (0.5%) of lead by weight**

**Bypass will not work if inlet pressure is above 150psi (10.3 bar).



N45BDU-M1

Features

- Double union connections (inlet and outlet) option DU
- Integral, stainless steel strainer
- Thermoplastic seat and cage
- Bronze body construction
- Serviceable in line
- Bypass feature controls thermal expansion pressure**
- Sealed spring cage on all models for accessible outdoor or pit installation

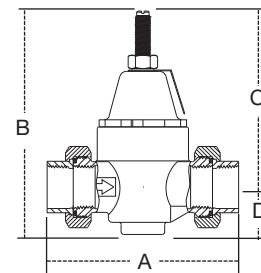

MODEL	SIZE (DN)		DIMENSIONS (APPROX.)								WEIGHT	
	in.	mm	A		B		C		D		lbs.	kgs.
N45BDU-M1	1/2	15	4 1/16	119	6 1/4	159	4 9/16	116	1 13/16	43	2.5	1.1
N45BDU-M1	3/4	20	4 1/16	119	6 1/4	159	4 9/16	116	1 13/16	43	2.5	1.1
N45BDU-M1	1	25	5 5/8	143	6 1/4	159	4 9/16	116	1 13/16	43	3	1.4

† Dimensions for all models are shown on literature ES-N45B.

Series N45B (1¼" – 2")

Water Pressure Reducing Valves

- Bronze body construction
- Ideal for residential and commercial applications
- Sealed spring cage on all models for waterworks pit installations
- Water savings up to 30%^A (see page 12)

Specifications

- Temperature Range: 33°F – 180°F (0.5°C – 82°C)
- Maximum Working Pressure: 300psi (20.7 bar)
- Adjustable Reduced Pressure Range: 25 – 75psi (172 – 517kPa)
- Standard Reduced Pressure Setting: 50psi (345kPa)

Standards

Meets requirements of ASSE Standard 1003 (ANSI A112.26.2); CSA Standard B356; and listed by IAPMO. City of Los Angeles.



Models

- N45B** – NPT threaded female inlet x NPT female outlet
- N45BU** – NPT threaded union inlet x NPT female outlet
- N45BU-S** – Solder Union inlet x NPT female outlet
- N45BDU** – Double Union – NPT threaded union female inlet and outlet
- N45BDU-S** – Double Union – Solder Union inlet and outlet

Options

add Suffix:

- G Gauge tapping
- GG Gauge tapping and 160psi (11.0 bar) gauge

For additional information, request literature ES-N45B-L.

*Bypass will not work if inlet pressure is above 150psi (10.3 bar)



N45BDU

Features

- Double union inlet & outlet connections
- Integral stainless steel strainer
- Thermoplastic seat & cage
- Bronze body construction
- Serviceable in line
- Bypass feature controls thermal expansion pressure*
- Sealed spring cage on all models for accessible outdoor or pit installations

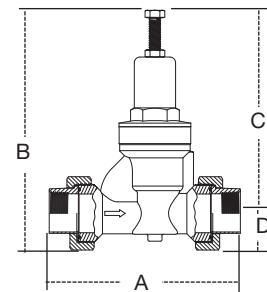

MODEL	SIZE (DN)		DIMENSIONS (APPROX.)								WEIGHT	
	in.	mm	A		B		C		D		lbs.	kgs.
N45BDU	1¼	32	8⅞	213	10⅞	262	8⅞	225	1⅞	36	6.5	2.9
N45BDU	1½	40	8⅞	213	10½	267	8⅞	225	1⅝	41	8	3.6
N45BDU	2	50	9	228	12⅞	319	8⅞	225	1⅞	47	9	4.1
N45BDU-S	1¼	32	7⅞	201	10⅞	262	8⅞	225	1⅞	36	6.5	2.9
N45BDU-S	1½	40	8¾	207	10½	267	8⅞	225	1⅝	41	8	3.6
N45BDU-S	2	50	9¼	235	12⅞	319	8⅞	225	1⅞	47	9	4.1

Series N45B-EZ-M1 (1/2" - 1")

Water Pressure Reducing Valves

- Bronze body construction
- Ideal for residential and commercial applications
- Factory calibrated outlet pressure adjustment
- Easily adjustable pressure setting
- Water savings up to 30%^A (see page 12)

Specifications

- Temperature Range: 33°F – 180°F (0.5°C – 82°C)
- Maximum Working Pressure: 400psi (27.6 bar)
- Adjustable Reduced Pressure Range: 25-75psi (172 - 517kPa)
- Standard Reduced Pressure Setting: 50psi (345kPa)

Standards

Meets requirements of ASSE Standard 1003 (ANSI A112.26.2); CSA Standard B356; and listed by IAPMO.



Models

- N45B-EZ-M1** – NPT threaded female inlet x NPT female outlet
- N45BU-EZ-M1** – NPT threaded union inlet x NPT female outlet
- N45BU-EZ-S-M1** – Solder Union inlet x NPT female outlet
- N45BDU-EZ-M1** – Double Union – NPT threaded union female inlet and outlet
- N45BDU-EZ-S-M1** – Double Union – Solder union inlet and outlet

Options

add Suffix:

- G Gauge tapping
- GG Gauge tapping and 160psi (11.0 bar) gauge

add Prefix:

- LF Lead Free* construction

For additional information, request literature ES-N45B-EZ.

***The combined metal components of this product contacted by potable water contain less than one half of one percent (0.5%) of lead by weight**

**Bypass will not work if inlet pressure is above 150psi (10.3 bar)



N45BDU-EZ-M1

Features

- Factory calibrated outlet pressure adjustment
- Easily adjustable pressure setting
- Double union inlet & outlet connections (option DU)
- Integral stainless steel strainer
- Thermoplastic cage & seat
- Bronze body construction
- Serviceable in line
- Bypass feature controls thermal expansion pressure**

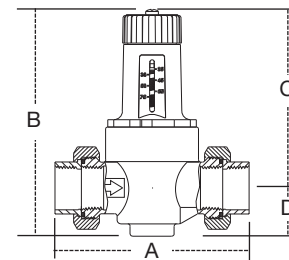

MODEL †	SIZE (DN)		DIMENSIONS (APPROX.)								WEIGHT	
	in.	mm	A		B		C		D		lbs.	kgs.
N45BDU-EZ-M1	1/2	15	4 1/16	119	6 1/16	154	4 3/8	111	1 1/16	43	6.5	2.9
N45BDU-EZ-M1	3/4	20	4 1/16	119	6 1/16	154	4 3/8	111	1 1/16	43	8	3.6
N45BDU-EZ-M1	1	25	5 5/8	143	6 1/16	154	4 3/8	111	1 1/16	43	9	1.4

† Dimensions for all models are shown on literature ES-N45B-EZ.

Series N45BDU-EZ (1¼" – 2")

Water Pressure Reducing Valves

- Bronze body construction
- Ideal for residential and commercial applications
- Factory calibrated outlet pressure adjustment
- Easily adjustable pressure setting
- Water savings up to 30%^Δ (see page 12)

Specifications

- Temperature Range: 33°F – 180°F (0.5°C – 82°C)
- Maximum Working Pressure: 300psi (20.7 bar)
- Adjustable Reduced Pressure Range: 25 – 75psi (172 – 517kPa)
- Standard Reduced Pressure Setting: 50psi (345kPa)

Standards

Meets requirements of ASSE Standard 1003 (ANSI A112.26.2); CSA Standard B356; and listed by IAPMO.



Models

N45BDU-EZ – Double Union - NPT threaded union female inlet and outlet

N45BDU-EZ-S – Double Union - Solder Union inlet and outlet

Options

add Suffix:

G gauge tapping

GG gauge tapping and 160psi (11.0 bar) gauge

For additional information, request literature ES-N45BDU-EZ-L.

*Bypass will not work if inlet pressure is above 150psi (10.3 bar)



N45BDU-EZ

Features

- Factory calibrated outlet pressure adjustment
- Easily adjustable pressure setting
- Double union inlet & outlet connections
- Integral stainless steel strainer
- Bronze body construction
- Serviceable in line
- Bypass feature controls thermal expansion pressure*

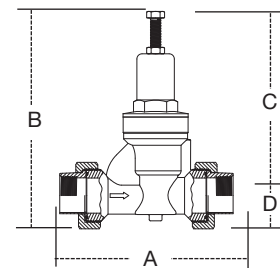

MODEL	SIZE (DN)		DIMENSIONS (APPROX.)								WEIGHT	
	in.	mm	A		B		C		D		lbs.	kg.
N45BDU-EZ	1¼	32	8⅜	213	9⅞	240	8	204	1⅞	36	6.5	2.9
N45BDU-EZ	1½	40	8⅜	213	9⅝	244	8	204	1⅝	41	8	3.6
N45BDU-EZ	2	50	9	228	9⅞	251	8	204	1⅞	47	9	1.4
N45BDU-EZ-S	1¼	32	7⅞	201	9⅞	240	8	204	1⅞	36	6.5	2.9
N45BDU-EZ-S	1½	40	8⅞	207	9⅝	244	8	204	1⅝	41	8	3.6
N45BDU-EZ-S	2	50	9¼	235	9⅞	251	8	204	1⅞	47	9	1.4

Series N55B-M1 (1/2" – 1")

Water Pressure Reducing Valves

- Bronze body construction
- Ideal for residential and commercial applications
- Integral stainless steel strainer and built-in bypass
- Water savings up to 30%^Δ (see page 12)

Specifications

- Temperature Range: 33°F – 180°F (0.5°C – 82°C)
- Maximum Working Pressure: 400psi (27.6 bar)
- Adjustable Reduced Pressure Range: 25-75psi (172 - 517kPa)
- Standard Reduced Pressure Setting: 50psi (345kPa)

Standards

Meets requirements of ASSE Standard 1003 (ANSI A112.26.2) and CSA Standard B356. Certified by NSF to ANSI/NSF Standard 61-8 (LF N55B-M1 Models only). Listed by IAPMO. City of Los Angeles



Models

- N55B-M1** – NPT threaded female inlet x NPT female outlet
- N55BU-M1** – NPT threaded union inlet x NPT female outlet
- N55BU-S-M1** – Solder Union inlet x NPT female outlet
- N55BU-QC-M1** – Single Union x Quick-Connect union inlet
- N55BDU-M1** – Double Union – NPT threaded union female inlet and outlet
- N55BDU-S-M1** – Double Union – Solder union inlet and outlet
- N55BDU-PEX-M1** – Double Union – PEX union inlet and outlet
- N55BDU-CPVC-M1** – Double Union – CPVC union inlet and outlet
- N55BDU-QC-M1** – Double Union – Quick-Connect union inlet and outlet

Options

add Suffix:

- G Gauge tapping
- GG Gauge tapping and 160psi (11.0 bar) gauge
- LP Low pressure range 10 – 35psi (69 – 241 kPa)

add Prefix:

- LF Lead Free* construction

For additional information, request literature ES-N55B.

***The combined metal components of this product contacted by potable water contain less than one half of one percent (0.5%) of lead by weight**

****Bypass will not work if inlet pressure is above 150psi (10.3 bar)**



N55BU-M1

Features

- Double union inlet & outlet connections (option DU)
- Integral stainless steel strainer
- Thermoplastic seat
- Bronze body construction
- Serviceable in line
- Bypass feature controls thermal expansion pressure**
- Sealed spring cage on all models for accessible outdoor or pit installations

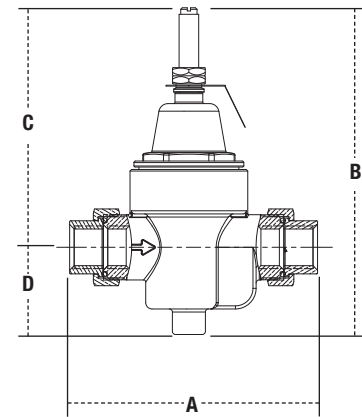

SIZE (DN)		DIMENSIONS (APPROX.)								WEIGHT	
		A		B		C		D		lbs.	kgs.
in.	mm	in.	mm	in.	mm	in.	mm	in.	mm		
1/2	15	4 1/16	103	6 1/4	159	4 9/16	116	1 11/16	43	1.5	.68
3/4	20	4 1/16	103	6 1/4	159	4 9/16	116	1 11/16	43	1.5	.68
1	25	4 7/8	124	6 1/4	159	4 9/16	116	1 11/16	43	1.75	.79

Series N55B (1¼" – 2")

Water Pressure Reducing Valves

- Bronze body construction
- Ideal for residential and commercial applications
- Sealed spring cage on all models for waterworks pit installations
- Water savings up to 30%^Δ (see below)



N55BDU

Specifications

- Temperature Range: 33°F – 180°F (0.5°C – 82°C)
- Maximum Working Pressure: 300psi (20.7 bar)
- Adjustable Reduced Pressure Range: 25 – 75psi (172 – 517 kPa)
- Standard Reduced Pressure Setting: 50psi (345 kPa)

Standards

Meets requirements of ASSE Standard 1003 (ANSI A112.26.2); CSA Standard B356; and listed by IAPMO.



Models

- N55B** – NPT threaded female inlet x NPT female outlet
- N55BU** – NPT threaded union inlet x NPT female outlet
- N55BU-S** – Solder Union inlet x NPT female outlet
- N55BDU** – Double Union – NPT threaded union female inlet and outlet
- N55BDU-S** – Double Union – Solder Union inlet and outlet

Options

add Suffix:

- G Gauge tapping
- GG Gauge tapping and 160psi (11.0 bar) gauge

For additional information, request literature ES-N55B-L.

**Bypass will not work if inlet pressure is above 150psi (10.3 bar)

Features

- Bronze cage
- Double union inlet & outlet connections
- Integral stainless steel strainer
- Thermoplastic seat
- Bronze body construction
- Serviceable in line
- Bypass feature controls thermal expansion pressure**
- Sealed spring cage on all models for accessible outdoor or pit installations

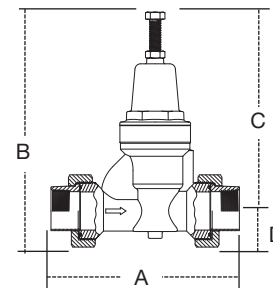

MODEL	SIZE (DN)		DIMENSIONS (APPROX.)								WEIGHT	
	in.	mm	A		B		C		D		lbs.	kgs.
N55BDU	1¼	32	8¾	213	10½	262	8¾	225	1¼	36	2.5	1.1
N55BDU	1½	40	8¾	213	10½	267	8¾	225	1½	41	2.5	1.1
N55BDU	2	50	9	228	12½	319	8¾	225	1¾	47	3	1.4
N55BDU-S	1¼	32	7½	201	10½	262	8¾	225	1¼	36	2.5	1.1
N55BDU-S	1½	40	8¾	207	10½	267	8¾	225	1½	41	2.5	1.1
N55BDU-S	2	50	9¼	235	12½	319	8¾	225	1¾	47	3	1.4

^Δ **Water Savings:** A water savings test program concluded that reducing the water supply pressure from 80psi to 50psi (551.2 – 344.8 kPa) resulted in a water savings of 30%. For additional information on conserving water and energy, request our F-23QA brochure – “23 Questions and Answers About Water Pressure Reducing Valves”.

Jumper Kits

Temporary Bypass for Water Pressure Reducing Valves

Jumper kits are used in new construction as a temporary bypass, prior to the actual installation of a water pressure reducing valve on potable water supply systems.

The use of a temporary jumper permits testing of the building piping system for leaks and pressure loss and facilitates pipe flushing prior to the installation of the water pressure reducing valve. On unsecured job sites, the jumper kit reduces loss from theft or vandalism.

Jumper Kits come complete with union connections, washers, and a brass or plastic pipe nipple with male union threads. The length of the jumper nipple matches the valve lay length, allowing the piping to be completed prior to the installation of a water pressure reducing valve and permitting quick change out from the jumper to the valve.

The jumper kits include a stainless steel strainer screen to provide protection from debris downstream of the valve.

How to order jumper kits

Example: 3/4" JK P-345 S

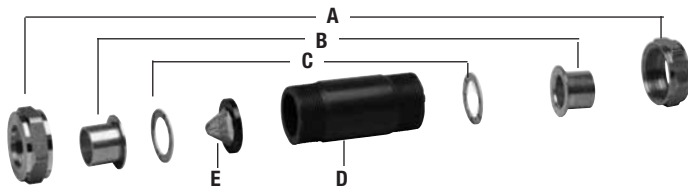
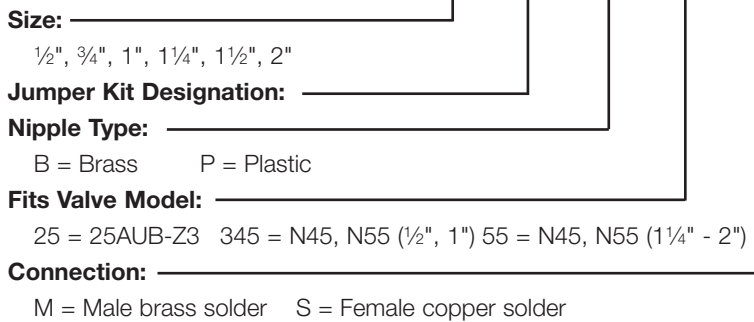

Jumper Kit Exploded View

Kit consists of:

- A – Union Nut (2)
- B – Sweat Tailpiece (2)
- C – Fiber Washer (2)
- D – Jumper Nipple
- E – Screen

For additional information, request literature ES-JumperKits.



Jumper Kit

JUMPER KITS COMPLETE KITS WITH PLASTIC NIPPLE

Model	Size	
	in.	mm
Female x Female Copper Sweat Tailpiece		
JK-P-25 S	3/4"	20
JK-P-345 S	3/4"	20
JK-P-25 S	1"	25
JK-P-345 S	1"	25
JK-P-25 S	1 1/4"	32
JK-P-55 S	1 1/4"	32
JK-P-25 S	1 1/2"	40
JK-P-55 S	1 1/2"	40
JK-P-25 S	2"	50
JK-P-55 S	2"	50

Female Copper Sweat x Male Brass Sweat Tailpiece

JK-P-345-FM S	3/4"	20
JK-P-345-FM S	1"	25

Male x Male Brass Sweat Tailpiece

JK-P-345-MM S	1"	25
---------------	----	----

COMPLETE KITS WITH BRASS NIPPLE

Female x Female Copper Sweat Tailpiece		
JK-B-25 S	3/4"	20
JK-B-345 S	3/4"	20
JK-B-25 S	1"	25
JK-B-345 S	1"	25
JK-B-25 S	1 1/4"	32
JK-B-55 S	1 1/4"	32
JK-B-25 S	1 1/2"	40
JK-B-55 S	1 1/2"	40
JK-B-25 S	2"	50
JK-B-55 S	2"	50

Jumper Kits Include: Jumper Nipple, strainer screen, 2 fiber washers, 2 union nuts and tailpieces as described above.

When removing Jumper Nipple and inserting the water pressure reducing valve, two O-rings (ordered separately) are required. Refer to literature PL-RP-GP for O-ring ordering information.

Series 223, 223S (1/2" – 2 1/2")

High Capacity Water Pressure Reducing Valves

- One of the most proven regulator designs available
- For commercial, institutional and industrial water pressure control applications
- Available with (223S) or without (223) a strainer



Specifications

- Temperature Range: 33°F – 160°F (0.5°C – 71°C)
- Maximum Working Pressure: 300psi (20.7 bar)
- Adjustable Reduced Pressure Range: 25-75psi (172 – 517kPa)
- Standard Reduced Pressure Setting: 50psi (345kPa)
- Size 1/2" – 2" (15 – 50mm) have bronze body construction
- Size 2 1/2" (65mm) has iron body construction

Standards

1/2" – 2" (15 – 50mm) Meets requirements of ASSE Standard 1003 (ANSI A112.26); CSA Standard B356; Southern Standard Plumbing Code, Military Standard MIL-V-18146B and listed by IAPMO.



Features

- Enlarged diaphragm, spring cage and seat orifice for super capacity performance
- Bronze body construction (except 2 1/2" which is iron)
- Serviceable in line
- Series 223S furnished with separate strainer
- Optional bypass feature controls thermal expansion pressure*
- Sealed spring cage on all models for waterworks pit installations

Models

223 – NPT female inlet x NPT threaded female outlet

223-S – NPT female inlet x NPT threaded female outlet with strainer

Options

add Suffix:

B Built-in bypass feature

LP Low pressure range 10-35psi (69 – 241 kPa)

HP High pressure range 1/2", 3/4", 1" (15, 20, 25mm) 50 – 145psi (3.4 – 10.0 bar);
1 1/4" (32mm) 50 – 120psi (3.4 – 8.3 bar);
1 1/2" – 2 1/2" (40 – 65mm) 50 – 95psi (3.4 – 6.6 bar)

For additional information, request literature ES-223.

*Bypass will not work if inlet pressure is above 150psi (10.3 bar)

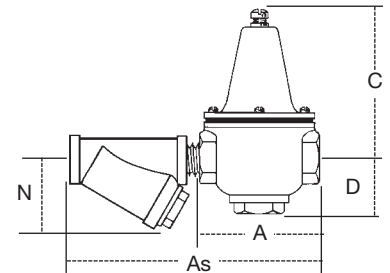

SIZE (DN)		BODY	DIMENSIONS (APPROX.)						WEIGHTS							
in.	mm		A (223)		As (223S)		C		D (223)		N (223S)		223		223S	
			in.	mm	in.	mm	in.	mm	in.	mm	in.	mm	lbs.	kgs.	lbs.	kgs.
1/2	15	Bronze	4 1/4	108	9	229	6 1/4	159	2	50	2 1/2	64	4.5	2.0	6.0	2.7
3/4	20	Bronze	4 1/4	108	9	229	6 1/4	159	2	50	2 1/2	64	5.0	2.3	6.5	2.9
1	25	Bronze	4 3/4	121	10 15/16	262	6 1/2	165	2 1/8	54	2 15/16	75	7.0	3.2	9.5	4.3
1 1/4	32	Bronze	5	127	11 15/16	287	6 3/4	172	2 3/4	70	3	76	9.0	4.1	12.0	5.4
1 1/2	40	Bronze	6 3/4	171	14 3/4	375	9 7/8	251	2 3/4	70	3 7/16	87	19.5	8.8	23.5	6.8
2	50	Bronze	8	203	16 3/4	425	10 3/4	273	3 3/8	86	4	102	30.0	13.6	37.5	17.0
2 1/2	65	Iron	9	229	20 7/8	511	10 3/4	273	3 3/8	86	5	127	32.5	14.8	59.0	26.8

Series N223B, N223BS (2½" – 3")

Super Capacity Water Pressure Reducing Valves

- For commercial, institutional and industrial applications
- Sealed spring cage on all models for waterworks pit installations
- Triple coated with special corrosion preventative materials superior to hot dip galvanizing

Specifications

- Temperature Range: 33°F – 160°F (0.5°C – 71°C)
- Maximum Working Pressure: 300psi (20.7 bar)
- Adjustable Reduced Pressure Range: 25 – 75psi (172 – 517kPa)
- Standard Reduced Pressure Setting: 50psi (345kPa)

**Bypass will not work if inlet pressure is above 150psi (10.3 bar)

Models

N223B – NPT threaded female inlet x NPT threaded female outlet

N223B-S - NPT threaded female inlet x NPT threaded female outlet with strainer

Options

add Suffix:

HP High pressure range 75 – 125psi (517 – 861 kPa)

For additional information, request literature ES-N223B.



N223B

Features

- Enlarged diaphragm, spring cage and seat orifice for super capacity performance
- Bronze body construction
- Serviceable in line
- Series N223S furnished with separate strainer
- Standard bypass feature controls thermal expansion pressure**
- Sealed spring cage on all models for waterworks pit installations

Series N223F, N223FS (3")

Super Capacity Water Pressure Reducing Valves

- Flanged connections
- For commercial or industrial applications
- Iron body construction
- Triple coated with special corrosion preventative materials superior to hot dip galvanizing

Specifications

- Size: 3" (80mm), flanged connections Class 125psi (8.6 bar) WSP
- Temperature Range: 33°F – 160°F (0.5°C – 71°C)
- Maximum Working Pressure: 175psi (12.1 bar)
- Adjustable Reduced Pressure Range 25 – 75psi (172 – 517 kPa).
- Standard Reduced Pressure Setting: 50psi (345 kPa)
- Model N223FS includes strainer

For additional information, request literature ES-N223F.



N223F

Series 127W, F127W (3", 4")

High Capacity Water Pressure Reducing Valves

- Remote control water regulator
- Close pressure regulation
- Single seated

Models

- **127W** - 3" (80mm) NPT threaded female inlet x female outlet connections, bronze body
- **F127W** - 3", 4" (80, 100mm) flanged connections, iron body

Specifications

- Maximum Working Pressure: 175psi (12.1 bar).
- Reduced Pressure Range: 25-100psi (172 – 690 kPa) depending on the supply pressure
- Temperature Range: 33°F – 160°F (0.5°C – 71°C)
- The 4" (100mm) size is tapped for the installation of a bypass line and an auxiliary regulator

For additional information, request literature ES-127W or ES-F127W.



F127W

Series N250 (1/2", 3/4")

Iron Body Water Pressure Reducing Valves

- Integral strainer
- Unitized construction for ease of maintenance
- For standard capacity domestic water pressure regulation

Specifications

- Sizes: 1/2", 3/4" (15, 20mm), NPT threaded female inlet and outlet connections
- Maximum Working Pressure: 250psi (17.2 bar)
- Standard Reduced Pressure Setting: 50psi (345 kPa)
- Adjustable Reduced Pressure Range: 25 – 75psi (172 – 517 kPa)
- Temperature Range: 33°F – 160°F (0.5°C – 71°C)

For additional information, request literature ES-N250.

Note: Cast Iron body regulators are not intended for buried or pit services.



N250

Series 123LP (1/2", 3/4")

Water Pressure Reducing Valves

- NPT threaded female inlet and outlet connections

Specifications

- Maximum Working Pressure: 200psi (13.8 bar)
- Reduced Pressure Setting: 25psi (172.4 kPa)
- Temperature Range: 33°F – 140°F (0.5°C – 60°C)
- Nominal size 1/2" (15mm) or 3/4" (20mm)
- Adjustable Pressure Range: 40 – 50psi (276 – 345 kPa)

For additional information, request literature ES-123LP.

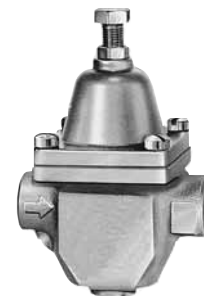

123LP

Series 2300 (3" – 6")

Direct Operated Water Pressure Reducing Valves

- Designed for dead-end water service where the flow is intermittent and changes rapidly, as on domestic water systems
- Ideal for fast acting equipment such as flushometers and snap cocks
- Pressure balanced design eliminates water hammer, pressure fluctuations, pressure creep and costly maintenance

For additional information, request literature ES-2300.



2300

Automatic Control Valves

"A" Series

- Pilot Controlled Diaphragm Valve
- Globe or Angle Pattern
- Threaded or Flanged Ends
- Modulating, On-Off, or Combination functions available

Specifications

Globe Pattern: 1¼" – 24" (32mm – 600mm)

Angle Pattern: 1¼" – 12" (32mm – 300mm)

Body & Cover: Ductile Iron ASTM A536 64-45-12

Coatings: NSF Approved Fusion Bonded Epoxy Coated and Lined

Valve Trim: 1¼" – 8": Stainless Steel 10" – 24": Bronze

Elastomers: Buna-N (std)

Tubing/Fittings: Copper and Brass

Threaded: 400psi MWP (27.6 bar)

150 Flanged: 250psi MWP (17.2 bar)

300 Flanged: 400psi MWP (27.6 bar)

Models

Numerous functional combinations are available in each valve series. Consult your Watts Representative for detailed assistance in selecting and sizing the proper ACV for your specific application.

110 Series – (Float / Level Control)

113 Series – (Solenoid & Pump Control)

114 Series – (Rate-of-Flow Control)

115 Series – (Pressure Reducing Control)

116 Series – (Pressure Relief, Sustaining, or Backpressure Control)

118 Series – (Check)

127 Series – (Altitude / Level Control)

Options

Materials

- Carbon Steel
- Stainless Steel
- Bronze

Elastomers

- Viton®

Tubing & Fittings

- Stainless Steel

For additional information, request literature C-CACV.

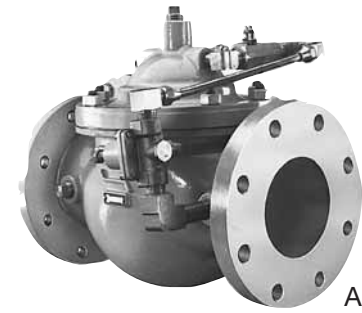

ACV

Features

- Exclusive "Quad-Seal" seat disc Retained on 3½ sides. Provides drip-tight, positive closure
- Long life non-edged seat Allows for longer seat life and superior low-flow performance
- Top and bottom guided stem Assures positive seat-to-disc alignment and stable throttling characteristics at low, intermediate, and peak flow rates
- 100% NSF approved fusion bonded epoxy lined and coated Reduces rust and corrosion, greatly extending the life of the main valve diaphragm. Shortens the time required for maintenance and improves valve flow coefficient
- FDA approved diaphragm Approved for use in drinking water systems

Series 26A, 263A (1/8" – 1/2")

Small Pressure Regulators

- Brass or stainless steel body regulators suitable for water and No. 2 fuel oil. Before using them with other liquids, please consult the factory
- Readily meets requirements for use in beverage dispensing and paint spraying equipment, drinking fountains and many other applications. We recommend the use of strainers with all regulators
- Series 263A has extra 1/4" low pressure gauge port and is available with all stainless steel construction, specify SS-263AP



SS263AP

Specifications

- Sizes: 1/8", 1/4", 3/8", 1/2" (3-15mm) NPT threaded female inlet and outlet connections
- Maximum Working Pressure: 300psi (20.7 bar)
- Maximum Temperature: 140°F (60°C).
- Available with Viton® trim
- Specify suffix letter for reduced pressure range required

Reduced Pressure Ranges:	Std. psi set at:	
Suffix A for 1 – 25psi	10	
Suffix B for 3 – 50psi	15	
Suffix C for 10 – 125psi	25	
Suffix D or 50 – 175psi	50	

Models

- 26A** 2-Way Regulator-Brass
- 263A** 3-Way Regulator-Brass
- SS263A** 3-Way Regulator-Stainless Steel

For additional information, request literature ES-26A, 263.

Model	SIZE (DN)		DIMENSIONS (APPROX.)								WEIGHT	
	in.	mm	A		B		C		D		oz.	gm.
26A	1/8	3	2 1/4	54	3 7/8	98	3	76	7/8	22	16	454
26A	1/4	8	2 1/4	54	3 7/8	98	3	76	7/8	22	16	454
26A	3/8	10	2 1/4	54	3 7/8	98	3	76	7/8	22	16	454
26A	1/2	15	2 1/4	54	4	100	3 1/8	79	7/8	22	16	454
263A	1/4	8	2 1/4	54	4 7/8	124	4	100	7/8	22	16	454
263A	3/8	10	2 1/4	54	4 7/8	124	4	100	7/8	22	16	454
263A	1/2	15	2 1/4	54	4	100	3 1/8	79	7/8	22	16	454

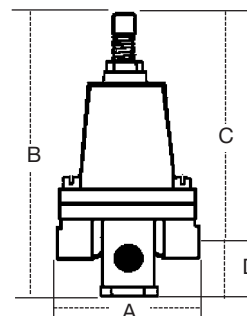

Series 560 (1/8" x 1/4", 3/4" x 3/4")

Mini Water Pressure Regulators

- General purpose brass body regulators for industrial, process, plumbing and OEM applications such as travel trailers. Consult factory for special requirements.

(20.7 bar). Maximum temperature 140°F (60°C)

H560 – Water regulation for grid systems. 3/4" (20mm) female inlet and male outlet hose connections. Max. pressure 150psi (10.3 bar), adjustable from 10 – 60psi (68.9 – 413.7 kPa). Standard set at 40psi (276 kPa). Delivery capacity up to 250 gallons per hour (946 lph). Also used for recreational vehicles. Listed by IAPMO



H560

Models

560 – has female threaded 1/8" and 1/4" (3 and 8mm) inlet and outlet connections. Female 1/8" (3mm) side tapping (plugged) for gauge. Initial pressures up to 300psi

For additional information, request literature ES-560/H560 or IS-IR-56/H560G.

Series IR-56 (3/4")

Bronze Water Pressure Regulators

- Dependable, low cost regulator for grid systems and recreational vehicles
- Hose connection, male inlet x male outlet

- 1/8" (3mm) NPT female side tapping for gauge
- Maximum Working Pressure: 150psi (10.3 bar)
- Adjustable Reduced Pressure Range: 10 – 60psi (68.9 – 413.7 kPa)
- Reduced Pressure Setting: 40psi (275.8 kPa)
- Delivery up to 250 gph (946 lph)

Specifications

- 3/4" (20mm) hose connection female inlet x male outlet



IR-56

For additional information, request literature IS-IR-56/H560G.

Series P60 (1/4")

Mini Plastic Water Pressure Regulators

- Compact, superior corrosion resistant regulators
- For general purpose, OEM and irrigation applications
- Can be used with deionized water
- Maximum Working Pressure: 300psi (20.7 bar)
- Maximum Temperature Range: 33°F – 150°F (0.5°C – 66°C)

Specifications

- 1/4" (8mm) NPT female connections
- **Reduced Pressure Range:**

- (A) 0 – 25psi (0 – 172 kPa);
- (B) 0 – 60psi (0 – 413 kPa);
- (C) 0 – 125psi (0 – 861 kPa)



P60

For additional information, request literature ES-P60.

Series 215 (1/4", 3/8")

Precision Regulator for Low Pressures

- Forged brass body, for water and No. 2 fuel oil
- For other liquids, consult factory

Specifications

- NPT threaded female inlet and outlet connections
- Maximum Working Pressure: 300psi (20.7 bar)
- Temperature Range: 0°F – 120°F (17.8°C – 49°C)



215

- **Reduced Pressure Ranges: Std. psi set at:**
- | | | |
|-----------------|---------------|-----------|
| Suffix A | for 0 – 8psi | 4 |
| Suffix B | for 0 – 20psi | 10 |
| Suffix C | for 0 – 50psi | 15 |

For additional information, request literature ES-215.

Model 276H300, IWTG (3/4")

Water Pressure Test Gauges

- For testing water supply pressure within a distribution system
- Red indicator hand "holds" at highest reading registered

Specifications

- 276H300** – 3/4" (20mm) hose thread connection; 0 – 300psi (0 – 20.7 bar)
- IWTG** – 3/4" (20mm) hose thread connection; 0 – 200psi (0 – 13.8 bar)



276H300

For additional information, request literature F-Gauges.

Series 152A, 252A (1/2" – 2")

Process Steam Pressure Regulators

- For autoclaves, steam tables/irons, vulcanizers and single radiators
- Also used on sterilizers, process lines, testing fixtures and oil lines
- Highly sensitive to reduced pressure changes
- Full volume with minimum pressure drop
- Sensitivity adjustment feature for critical flow

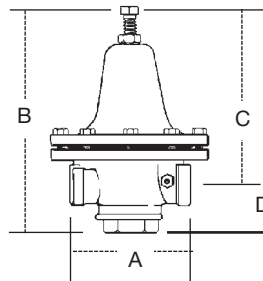

152A

Models

152A – with iron body. Sizes: 1/2" to 2" (15-50mm), NPT threaded female inlet and outlet connections. Initial pressures up to 200psi (13.8 bar)

152SS – with stainless steel body and trim, sizes 1/2", 3/4", 1" (15, 20, 25mm). For maximum supply pressure up to 300psi (20.7 bar) at 420°F (216°C)

252A – sizes 1/2", 3/4" (15, 20mm) identical to 152A except furnished in bronze body for pressures up to 300psi (20.7 bar)

152A-T, 152SS-T or 252A-T – tight seating models for dead end and liquid service. When utilizing a Teflon® valve disc in the 252A-T, the maximum operating temperatures are 300°F (149°C) at 300psi (20.7 bar) and 400°F (204°C) at 200psi (13.8 bar).

See capacity chart on pg. 12 for max. ratings.

For additional information, request literature ES-152A, ES-152SS.

MODEL	SIZE (DN)	DIMENSIONS (APPROX.)								WEIGHT			
		A		B		C		D		lbs.	kgs.		
		in.	mm	in.	mm	in.	mm	in.	mm				
152A	3 – 15	1/2	15	6	150	8 5/8	219	6 7/8	175	1 3/4	44	12	5
152A	3 – 15	3/4	20	6	150	8 5/8	219	6 7/8	175	1 3/4	44	12	5
152A	3 – 15	1	25	7 1/2	191	9 1/4	235	7 1/4	184	2	50	20	9
152A	3 – 15	1 1/4	32	7 1/2	191	9 1/4	235	7 1/4	184	2	50	20	9
152A	5 – 40	1 1/2	40	9	229	14 1/4	362	11 1/2	292	2 3/4	70	40	18
152A	5 – 40	2	50	9	229	14 1/4	362	11 1/2	292	2 3/4	70	40	18
252A	10 – 50	1/2	15	6	150	8 5/8	219	6 7/8	175	1 3/4	44	12	5
252A	10 – 50	3/4	20	6	150	8 5/8	219	6 7/8	175	1 3/4	44	12	5
152SS	10 – 50	1/2	15	6	150	8 5/8	219	6 7/8	175	1 3/4	44	12	5
152SS	10 – 50	3/4	20	6	150	8 5/8	219	6 7/8	175	1 3/4	44	12	5
152SS	10 – 50	1	25	7 1/2	191	9 1/4	235	7 1/4	184	2	50	20	9

Series 127 (1/2" – 4")

Process Steam Pressure Regulators

- Diaphragm type regulator
- Single seated
- Large capacity
- Main line process regulation
- Heating and dead end service
- Institutional, commercial and industrial applications

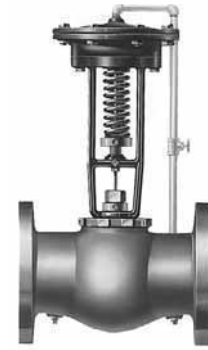
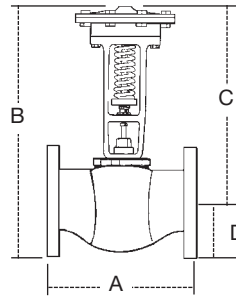

F127SS

Specifications

- Sizes: 1/2" – 3" (15 – 80mm), bronze body with NPT threaded inlet and outlet connections
- Sizes: 1/2" – 3" (15 – 80mm) feature stainless steel discs
- Adjustable Reduced Pressure Range: 5 – 150psi (.3 – 10.3 bar) depending on size of the valve and supply pressure

For additional information, request literature F-127.

MODEL	SIZE (DN)		DIMENSIONS (APPROX.)							
	in.	mm	A		B		C		D	
			in	mm	in	mm	in	mm	in	mm
127	1/2	15	4	102	16	406	15	381	1	25
127	3/4	20	4	102	16	406	15	381	1	25
127	1	25	4 1/4	108	16 1/8	410	15	381	1 1/8	29
127	1 1/4	32	4 1/2	114	16 3/8	416	15 1/8	384	1 1/4	32
127	1 1/2	40	5 1/4	133	16 3/4	425	15 1/4	387	1 1/2	38
127	2	50	6	152	17 1/8	435	15 3/8	391	1 3/4	44
127	2 1/2	65	7 1/4	184	17 7/8	454	15 3/4	400	2 1/8	54
127	3	80	8	203	18 1/2	470	16 1/8	410	2 3/8	60
F127*	3	80	8	203	20 1/2	521	16 3/4	425	3 3/4	95
F127*	4	100	12 1/8	308	21 1/4	540	16 3/4	425	4 1/2	114

*Iron body, flanged connections

Quick Reference Capacity Chart

MAXIMUM CAPACITIES In Pounds or Kilograms (lbs. or kgs.) per Hour of Steam

MODEL	SIZE (DN)		FROM 50PSI (3.4 BAR)		FROM 100PSI (6.9 BAR)		FROM 150PSI (10.3 BAR)		FROM 200PSI (13.8 BAR)		FROM 250PSI (17.2 BAR)	
	in.	mm	lbs./hr.	kgs./hr.	lbs./hr.	kgs./hr.	lbs./hr.	kgs./hr.	lbs./hr.	kgs./hr.	lbs./hr.	kgs./hr.
			REDUCED PRESSURE UP TO 20PSI (1.4 BAR)		REDUCED PRESSURE UP TO 50PSI (3.4 BAR)		REDUCED PRESSURE UP TO 70PSI (4.8 BAR)		REDUCED PRESSURE UP TO 90PSI (6.2 BAR)		REDUCED PRESSURE UP TO 125PSI (8.6 BAR)	
127	1/2	15	218	99	387	175	555	252	731	332	900	408
127	3/4	20	492	223	875	397	1255	569	1653	750	2037	924
127	1	25	878	398	1560	708	2237	1015	2943	1131	3631	1647
127	1 1/4	32	1370	621	2436	1105	3493	1584	4599	2086	5668	2570
127	1 1/2	40	1973	895	3508	1591	5030	2282	6623	3004	8163	3703
127	2	50	3518	1596	6253	2836	8967	4067	11807	5356	14553	6601
127	2 1/2	65	5494	2492	9766	4430	14006	6353	18442	8365	22730	10310
127	3	80	7906	3586	14054	6375	20154	9142	26538	12037	32709	14837
F127	3	80	7906	3586	14054	6375	20154	9142	–	–	–	–
F127	4	100	8301	3765	14756	6693	21161	9598	–	–	–	–
152A	1/2	15	80	36	143	65	205	93	270	122	332	151
252A	1/2	15	80	36	143	65	205	93	270	122	332	151
152A	3/4	20	285	129	506	230	726	329	956	434	1178	534
252A	3/4	20	285	129	506	230	726	329	956	434	1178	534
152A	1	25	402	182	715	324	1025	465	1349	612	1663	754
152A	1 1/4	32	442	200	786	357	1127	511	1484	673	1830	830
152A	1 1/2	40	665	302	1120	508	1600	726	2230	1012	2725	1236
152A	2	50	765	347	1285	583	1840	835	2564	1163	3134	1422

EXAMPLE: Initial Pressure is 100psi (6.9 bar), Reduced Pressure is 50psi (3.4 bar) and Capacity required is 1500 lbs. (680 kgs.) of steam per hour. By referring to the proper initial reduced pressure column "From 100psi/Up to 50psi (6.9 – 3.4 bar)", you will find the capacity of 1560 lbs./hr. (708 kgs./hr.) for the 1" (25mm) Model 127 valve corresponds most closely to the required capacity of 1500 lbs./hr.

NOTE: For reduced pressures greater than those shown for each Initial Pressure column above, refer to the Detailed Capacity Table in the Watts brochure F-127. Be sure to determine both Initial Pressure and Reduced Pressure setting, or the range required.

Series 174A (3/4" – 2") Model 374A (3/4")

ASME Water Pressure Safety Relief Valves

- For hot water heating and supply boilers
- Pressure protection only
- Series 174A bronze body construction resists corrosive water conditions of water supplies



174A

Specifications

- Standard Pressure Relief Setting: 30psi (206.9 kPa).
- Other valve settings are available in 5psi (34.5 kPa) increments from 30 – 150psi (2.1 – 10.3 bar)

Models

174A – Sizes 3/4" – 2" (20 – 50mm), NPT threaded female inlet x female outlet (drain) connection

374A has iron body with bronze inlet; 550,000 BTU/hr. rating

For additional information, request literature ES-174A-740.

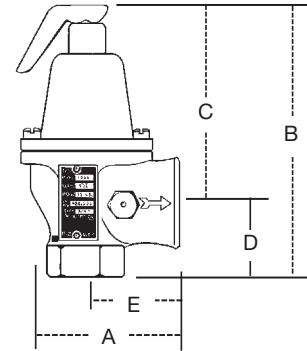

MODEL	SIZE (DN)		DIMENSIONS (APPROX.)										WEIGHT	
	in.	mm	A		B		C		D		E		lbs.	kgs.
174A	3/4	20	2 1/2	64	4 7/8	124	3 3/4	95	1 1/8	29	1 5/8	41	1.5	0.7
174A	1	25	3	76	5 7/8	149	4 3/8	111	1 1/2	38	1 7/8	48	3.1	1.4
174A	1 1/4	32	4 3/4	121	8 1/2	216	6 3/8	162	2 1/8	54	2 3/8	60	6.3	2.8
174A	1 1/2	40	4 7/8	124	9 1/4	235	6 3/4	171	2 1/2	64	2 5/8	67	7.3	3.3
174A	2	50	6 1/2	165	10 1/4	260	7 1/4	184	3	76	3 3/8	86	13.8	6.2
374A	3/4	20	2 1/2	64	3 5/8	72	2 3/8	60	1 1/4	32	1 1/2	38	1.1	0.5

Safety Relief Valves Settings and Relieving Capacities

(National Board Certified Ratings) BTU Steam Discharge Capacities (lbs./hr.)

MODEL	SIZE (DN)		30PSI	100PSI	125PSI	150PSI
	in.	(mm)				
174A	3/4	20	650,000	1,695,000	2,070,000	2,445,000
174A	1	25	1,005,000	2,635,000	3,215,000	3,795,000
174A	1 1/4	32	1,682,000	4,399,000	5,370,000	6,340,000
174A	1 1/2	40	2,020,000	5,290,000	6,460,000	7,630,000
174A	2	50	3,815,000	9,970,000	12,170,000	14,370,000
374A	3/4	20	550,000	–	–	–

Note: Valve settings, other than shown above, are available in 5psi increments within the pressure ranges shown.

Series 740 (3/4" – 2")

Iron Body ASME Rated Water Pressure Relief Valves

- For hot water heating boiler pressure protection
- Expanded outlet drain connections
- Size for size, Watts 740 Models offer greater discharge capacity than comparable competitive models



740

Specifications

- NPT threaded female inlet x female outlet (drain) connection
- Sizes 3/4" x 1" (20 x 25mm), 1" x 1 1/4" (25 x 32mm), 1 1/4" x 1 1/2" (32 x 40mm), 1 1/2" x 2" (40 x 50mm), 2" x 2 1/2" (50 x 65mm)
- Standard pressure relief setting is 30psi (206.9 kPa)
- Other settings available in 5psi (34.5 kPa) increments from 30 – 75psi (206.9 – 5.2 bar)

For additional information, request literature ES-174A/740.

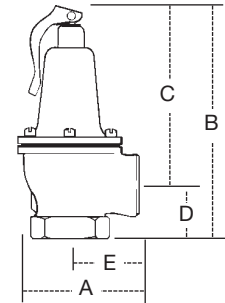

MODEL	SIZE (DN)		DIMENSIONS (APPROX.)										WEIGHT	
	in.	mm	A		B		C		D		E		lbs.	kgs.
740	3/4 x 1	20 – 25	3	76	5 7/8	149	4 3/8	111	1 1/2	38	1 7/8	48	1.9	.9
740	1 x 1 1/4	25 – 32	3 1/2	89	7 1/4	184	5 3/8	137	1 7/8	48	2 1/8	54	3.1	1.4
740	1 1/4 x 1 1/2	32 – 40	4 5/8	117	8 3/4	222	6 1/2	165	2 1/4	57	2 5/8	67	6.1	2.8
740	1 1/2 x 2	40 – 50	5 1/4	133	9 1/4	235	7	178	2 1/4	57	3	76	7.5	3.4
740	2 x 2 1/2	50 – 65	6 3/4	171	11 5/8	295	8 3/4	222	2 7/8	73	3 3/8	98	16.5	7.5

Safety Relief Valves Settings and Relieving Capacities

(National Board Certified Ratings) BTU Steam Discharge Capacities (lbs./hr.)

MODEL	SIZE (DN)		30PSI	45PSI	50PSI	75PSI
	in.	mm				
740	3/4 x 1	20 x 25	925,000	1,245,000	1,352,000	1,886,000
740	1 x 1 1/4	25 x 32	1,300,000	1,750,000	1,899,000	2,649,000
740	1 1/4 x 1 1/2	32 x 40	2,105,000	2,830,000	3,075,000	4,285,000
740	1 1/2 x 2	40 x 50	2,900,000	3,903,000	4,237,000	5,909,000
740	2 x 2 1/2	50 x 65	5,250,000	7,067,000	7,672,000	10,700,000

Note: Valve settings, other than shown above, are available in 5psi increments within the pressure ranges shown.

Contact your local Watts Agent or call Customer Service (978) 689-6066 for the products with a relief setting other than shown and/or special models of interest.

Series 315 and 415 (3/4" – 1 1/2")

ASME Rated and Tested Steam Safety Relief Valves

- For low pressure steam heating equipment

Specifications

- NPT threaded male inlet x threaded female outlet (drain) connection
- Standard relief set pressure 15psi (103.4 kPa)
- Available with lower pressure relief settings, consult factory
- Model 315 – 3/4" x 3/4" (20 x 20mm),
Model 415 – 3/4" x 3/4" (20 x 20mm), 1" x 1" (25 x 25mm),
1 1/4" x 1 1/2" (32 x 40mm), and 1 1/2" x 2" (40 x 50mm)



315

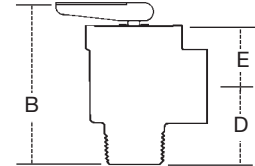

MODEL	SIZE <i>in</i>	ASME STEAM Discharge Capacity <i>lbs./hr. @ 15psi</i>	DIMENSIONS (APPROX.)						WEIGHT	
			B		D		E		<i>lbs.</i>	<i>kgs.</i>
			<i>in.</i>	<i>mm</i>	<i>in.</i>	<i>mm</i>	<i>in.</i>	<i>mm</i>		
315-M1	3/4 x 3/4	375	2 1/16	68	1 3/8	35	1 1/4	32	.55	.24
415-M1	3/4 x 3/4	450	2 13/16	71	1 5/16	33	1 1/4	32	.70	.31
415-M1	1 x 1	643	3 3/8	78	1 11/16	43	1 5/8	41	.91	.41
415	1 1/4 x 1 1/2	1230	4 3/4	121	2 3/8	60	2 1/8	54	2.00	.91
415	1 1/2 x 2	1860	5 7/16	138	2 5/8	67	2 5/16	59	3.00	1.36

Series Fig. 31, 41, 41A (1/2" – 6")

Safety Relief Valves

Specifications

- Available in bronze with threaded connections or cast iron with flanged connections
- **Fig. 31** – ASME Section I valves for steam boilers with pressures to 250psi (17.2 bar)
- **Fig. 41** – For ASME Section VIII steam service handling saturated steam to 250psi (17.2 bar)
- **Fig. 41A** – For ASME Section VIII service on air, gas and vapors to 250psi (17.2 bar)
- Saturated Steam Capacities; see tables on page 23
- Next day service available

For additional information, request literature PG-SSRV.



Fig. 31, 41, 41A

Fig. 31 ASME Section I Series Valves Saturated Steam Capacities

(lbs/hr @ 90% rating and 3% overpressure)

MODEL	SET PRESSURE		INLET X OUTLET (IN.)					
	psi	kPa	1/2 x 3/4	3/4 x 1	1 x 1 1/4	1 1/4 x 1 1/2	1 1/2 x 2	2 x 2 1/2
Fig. 31	5*	34	96	171	269	439	686	1126
Fig. 31	10*	69	133	238	372	609	952	1562
Fig. 31	15	103	161	288	451	738	1154	1893
Fig. 31	20	138	189	337	528	864	1351	2216
Fig. 31	25	172	216	386	605	990	1548	2540
Fig. 31	30	207	244	435	683	1116	1745	2863
Fig. 31	50	345	355	632	991	1621	2543	4157
Fig. 31	75	517	493	878	1377	2251	3519	5774
Fig. 31	100	689	631	1124	1763	2882	4505	7391
Fig. 31	125	861	769	1370	2148	3512	5491	9008
Fig. 31	150	1034	907	1616	2534	4143	6477	10625
Fig. 31	175	1206	1045	1862	2920	4773	7462	12242
Fig. 31	200	1378	1183	2108	3306	5404	8448	13859
Fig. 31	225	1550	1321	2354	3691	6035	9434	15477
Fig. 31	250	1723	1459	2600	4077	6665	10419	17094

* Capacities for 5 and 10psi are not certified by ASME National Board.

Fig. 41 ASME Section VIII Series Valves Saturated Steam Capacities

(lbs/hr @ 90% rating and 10% overpressure)

MODEL	SET PRESSURE		INLET X OUTLET (IN.)					
	psi	kPa	1/2 x 3/4	3/4 x 1	1 x 1 1/4	1 1/4 x 1 1/2	1 1/2 x 2	2 x 2 1/2
Fig. 41	5*	34	104	185	289	473	739	1213
Fig. 41	10*	69	141	250	393	642	1003	1646
Fig. 41	15	103	176	361	491	802	1254	2057
Fig. 41	20	138	203	361	566	925	1445	2371
Fig. 41	25	172	229	409	641	1047	1637	2686
Fig. 41	30	207	256	456	716	1170	1829	3000
Fig. 41	50	345	374	666	1045	1709	2672	4384
Fig. 41	75	517	522	930	1458	2383	3726	6113
Fig. 41	100	689	669	1193	1870	3058	4780	7843
Fig. 41	125	861	817	1456	2283	3732	5835	9572
Fig. 41	150	1034	965	1719	2696	4407	6889	11302
Fig. 41	175	1206	1113	1982	3108	5031	7943	13032
Fig. 41	200	1378	1260	2245	3521	5756	8998	14761
Fig. 41	225	1550	1408	2508	3933	6430	10052	16491
Fig. 41	250	1723	1556	2771	4346	7105	11106	18221

* Capacities for 5 and 10psi are not certified by ASME National Board.

Fig. 41A ASME Section VIII Air Capacity Ratings

(SCFM @ 90% rating and 10% overpressure)

MODEL	SET PRESSURE		INLET X OUTLET (IN.)					
	psi	kPa	1/2 x 3/4	3/4 x 1	1 x 1 1/4	1 1/4 x 1 1/2	1 1/2 x 2	2 x 2 1/2
Fig. 41A	5*	34	37	65	102	167	261	428
Fig. 41A	10*	69	50	89	140	228	356	585
Fig. 41A	15	103	63	111	175	285	446	732
Fig. 41A	20	138	72	128	201	329	514	844
Fig. 41A	25	172	82	145	228	373	583	956
Fig. 41A	30	207	91	162	255	416	651	1068
Fig. 41A	50	345	133	237	372	608	951	1550
Fig. 41A	75	517	185	331	519	848	1326	2176
Fig. 41A	100	689	238	424	665	1088	1701	2791
Fig. 41A	125	861	291	518	812	1328	2076	3407
Fig. 41A	150	1034	343	611	959	1568	2452	4022
Fig. 41A	175	1206	396	705	1210	1808	2827	4638
Fig. 41A	200	1378	448	799	1253	2048	3202	5254
Fig. 41A	225	1550	501	892	1400	2288	3578	5869
Fig. 41A	250	1723	553	986	1547	2528	3953	6435
Fig. 41A	275	1895	606	1080	1693	2769	4328	7101
Fig. 41A	300	2067	659	1173	1840	3009	4703	7716

* Capacities for 5 and 10psi are not certified by ASME/National Board.

Series 1L, 1XL, 10L and 100XL (1/2" , 3/4")

Self-closing T&P Safety Relief Valves for Hot Water Storage Tanks and Heaters

- These combined two-in-one Temperature and Pressure relief valves provide the least expensive and proven means for protection against both excessive temperature and pressure emergency conditions
- Fully automatic temperature and pressure relief protection for domestic hot water supply tanks and heaters based on the latest ANSI Z21.22 listing requirements for temperature discharge capacity
- Reliable and proven means of protection against excessive temperature and pressure build-up in domestic hot water systems
- Includes test lever
- For water heaters from 15,000 to 105,000 BTU/hr
- NPT male inlet and female outlet

Note: See pg. 25 for information on domestic expansion tanks (DET) to control thermal expansion in domestic water closed systems.

For additional information, request literature ES-10L, ES-100XL, ES-SL100XL/L100XL/LL100XL/ LLL100XL.

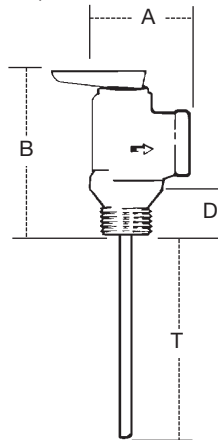

Standards

- ANSI Z21.22 and ASME Section IV Rated†, CSA Listed.

Specifications

- Temperature Relief: 210°F (99°C). Pressure Relief Range: 75 – 150psi (5.2 – 10.3 bar). Standard Pressure Relief Settings: 75psi (5.2 bar), 100psi (6.9 bar), 125psi (8.6 bar) or 150psi (10.3 bar)

MODEL	SIZE (DN)		DIMENSIONS (APPROX.)								WEIGHT		CSA
	in.	mm	A		B		D		T		oz.	gm.	Temp. Steam Rating BTU/hr.
1L2†	1/2	15	1 3/4	43	3 1/2	89	7/8	22	2	50	10	284	15,000
1XL†	1/2	15	1 3/4	43	3 1/2	89	7/8	22	3	76	12	340	15,000
1XL-8†	1/2	15	1 3/4	43	3 1/2	89	7/8	22	8	203	16	454	15,000
10L-2	3/4	20	1 3/4	43	3 1/2	89	1 1/8	29	2	50	10	284	80,000
100XL	3/4	20	1 3/4	43	3 1/2	89	1 1/8	29	3	76	12	340	105,000
100XL-8	3/4	20	1 3/4	43	3 1/2	89	1 1/8	29	8	203	14	397	105,000
L100XL-3	3/4	20	1 3/4	43	4 1/4	108	2 1/8	41	3	76	12	340	105,000
SL100XL	3/4	20	1 3/4	43	4 3/8	111	1 1/4	32	3 1/2	89	12	340	105,000
LL100XL	3/4	20	1 3/4	43	4 3/4	121	2	50	2 1/2	64	12	340	105,000
LLL100XL-Z5	3/4	20	1 3/4	43	5 1/4	133	2 1/2	64	2 1/8	54	12	340	105,000

A = overall width of the valve. B = overall height of the valve, with lever closed, not including thermostat element length. D = length of shank, from shoulder under outlet orifice overhang to inlet orifice edge. T = length of thermostat element, measured from inlet orifice edge to end of thermostat.

Set @ 150psi (10.3 bar). Consult your local Watts Agent or call Customer Service at (978) 689-6066 for ordering codes of valves with pressure relief settings of 75, 100, 125psi (5.2, 6.9, 8.6 bar).

†1/2" (15mm) valves are not ASME rated.

Series 210-5 (3/4")

Immersion-Type, Temperature Gas Shutoff for Hot Water Storage Heaters.

- Protects against excessive temperatures in gas water heaters
- Shuts off the gas supply to the water heater in the event that the water temperature reaches 210°F (98.9°C)
- Used in conjunction with Model 3L pressure relief valve, p.20
- Models L210-5 M2, LL210-5 M2, LLL210-5 feature extended shanks for use with heaters containing up to 3" of insulation

Specifications

- Tank connection 3/4" (20mm) NPT male
- Gas inlet and outlet connection 1/2" (15mm) NPT female

- Design certified by CSA
- CSA ratings: natural gas 150,000 BTU/hr., liquefied petroleum gas 243,000 BTU/hr

For additional information, request literature ES-210-5.

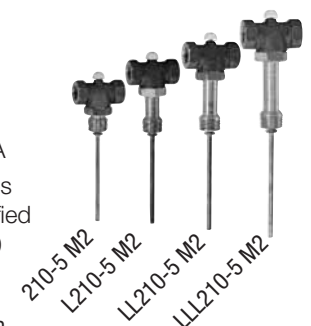

ASME Rated Series 40, 140, 240, 340, 342 (3/4" – 2")

Automatic Reseating T&P Relief Valves for Hot Water Supply Tanks and Heaters.

- The combined two-in-one Temperature and Pressure relief valve provides the least expensive and most proven means for protection against both excessive temperature and pressure.
- Fully automatic temperature and pressure relief protection for hot water supply tanks and heaters based on the latest ANSI Z21.22 Listing Requirements for temperature discharge capacity.

Standards

ANSI Z21.22 and ASME Section IV Rated, CSA Listed.

Specifications

- Temperature relief 210°F (98.9°C). Pressure range 75 – 150psi (5.2 – 10.3 bar). Standard settings: 75psi (5.2 bar); 100psi (6.9 bar); 125psi (8.6 bar); and 150psi (10.3 bar). See Dimensions/Wgts. chart on next page for inlet and outlet connection type and sizes.

Series 40, 140 nominal size 3/4" (20mm)

- To protect gas, electric or oil-fired storage water heaters rated between 180,000 to 200,000 BTU/Hr. from excessive heat or pressure build up, choose the 3/4" (20mm) model 40 or 140. Tested under ANSI Z21.22 with ratings as certified and listed by CSA. Series 40, 140 and 240 nominal size 1" (25mm).
- For gas or oil-fired storage water heaters rated between 450,000 and 730,000 BTU/Hr., choose the 1" (25mm) model 40, 140 or 240. Tested under ANSI Z21.22 with ratings as certified and listed by CSA.

Series 340, 342 nominal sizes 1 1/2" x 2" (40 x 50mm)

- For gas or oil-fired hot water supply boilers rated over 730,000 BTU/Hr. output heating for water and for steam coil storage water heaters, choose the Model 340 or 342. Tested under ANSI Z21.22 with ratings as certified and listed by CSA.

Special Model

Special Model 340X-8 M4Z available in 1 1/2" (40mm) size only. Pressure setting is 175psi (12.1 bar). Temperature relief at 210°F (98.9°C); Certified by CSA only.

For additional information, request literature ES-40, 140, 240, 340, or ES-LL/LLL-40XL.



340

Features

- Bronze body construction
- Tamper-resistant bonnet screws
- Series 40 and 140 feature a unique thermostat with a special thermo-bonded coating
- 1" (25mm) and above sizes Model M2, M4 and M14 are standardly furnished with stainless steel thermostat tube
- Accurate and proven thermostat, exclusively designed and manufactured by Watts

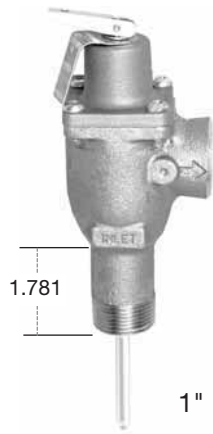

1" LL40XL-Z2



3/4" LL40XL-Z2



3/4" LLL40XL-Z2

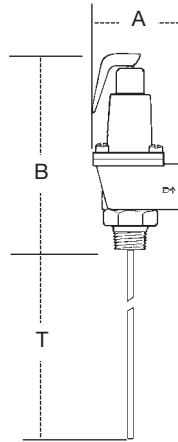

Series 40L

MODEL	SIZE (DN)		THERMOSTAT LENGTH		DIMENSIONS (APPROX.)				WEIGHT		RATINGS		
	M = MALE F = Female Inlet x Outlet		T (below inlet)		A		B less thermostat		lbs.	kgs.	CSA TEMP. STEAM RATING	ASME PRESSURE STEAM RATING	ASME PRESSURE STEAM RATING
	in. x in.	mm x mm	in.	mm	in.	mm	in.	mm			BTU/hr.	BTU/hr.** @75psi set pressure	BTU/hr.** @150psi set pressure
40L-3	3/4M x 3/4F	20 x 20	3	76	2 5/8	67	5 5/8	143	1 3/4	.79	180,000	777,600	1,437,600
40XL-5	3/4M x 3/4F	20 x 20	5	127	2 5/8	67	5 5/8	143	1 3/4	.79	205,000	777,600	1,437,600
40XL-8	3/4M x 3/4F	20 x 20	8	200	2 5/8	67	5 5/8	143	1 3/4	.79	205,000	777,600	1,437,600
LL40XL	3/4M x 3/4F	20 x 20	3 1/2	89	2 5/8	67	5 5/8	143	1 1/2	.68	205,000	777,600	1,437,600
LLL40XL	3/4M x 3/4F	20 x 20	5	127	2 5/8	67	7 7/8	194	2	.90	205,000	777,600	1,437,600
140S-3	3/4F x 3/4F	20 x 20	3	76	2 5/8	67	5 5/8	143	1 3/4	.79	180,000	777,600	1,437,600
140X-5	3/4F x 3/4F	20 x 20	5	127	2 5/8	67	5 5/8	143	1 3/4	.79	205,000	777,600	1,437,600
140X-8	3/4F x 3/4F	20 x 20	8	200	2 5/8	67	5 5/8	143	1 3/4	.79	205,000	777,600	1,437,600
40L-2	1M x 1F	25 x 25	2	50	2 3/4	70	6 1/4	158	2 1/4	1.00	450,000	1,155,000	2,134,000
40XL-4	1M x 1F	25 x 25	4	100	2 3/4	70	6 1/4	158	2 1/4	1.00	500,000	1,555,000	2,134,000
40XL-7	1M x 1F	25 x 25	7	178	2 3/4	70	6 1/4	158	2 1/4	1.00	500,000	1,555,000	2,134,000
LL40XL	1M x 1F	25 x 25	3	76	2 3/4	70	6 1/2	165	2	.90	500,000	1,155,000	2,134,000
*140S-3	1F x 1F	25 x 25	3	76	3	76	5 1/2	140	2 1/4	1.00	570,000	1,670,000	3,085,000
*140X-6	1F x 1F	25 x 25	6	150	3	76	5 1/2	140	2 1/4	1.00	670,000	1,670,000	3,085,000
*140 X-9	1F x 1F	25 x 25	9	229	3	76	5 1/2	140	2 1/4	1.00	670,000	1,670,000	3,085,000
*N240X-6	1F x 1F	25 x 25	6	150	3 3/8	86	6 5/8	168	2 3/4	1.20	730,000	2,195,000	4,059,000
*N240X-9	1F x 1F	25 x 25	9	229	3 3/8	86	6 5/8	168	2 3/4	1.20	730,000	2,195,000	4,059,000
*N241X-5	1 1/4M x 1F	32 x 25	5	127	3 3/8	86	6 5/8	168	2 3/4	1.20	730,000	2,195,000	4,059,000
*N241X-8	1 1/4M x 1F	32 x 25	8	200	3 3/8	86	6 5/8	168	2 3/4	1.20	730,000	2,195,000	4,059,000
*340-3	1 1/2F x 1 1/2F	40 x 40	3	76	4 1/2	114	9 3/4	248	7	3.00	1,150,000	3,450,000	6,379,000
*340X-8†	1 1/2F x 1 1/2F	40 x 40	8	200	4 1/2	114	9 3/4	248	8	3.60	1,150,000	3,450,000	6,379,000
*342-3	2M x 1 1/2F	50 x 40	3	76	4 1/2	114	9 3/4	248	7	3.00	1,150,000	3,450,000	6,379,000
*342X-8	2M x 1 1/2F	50 x 40	8	200	4 1/2	114	9 3/4	248	8	3.60	1,150,000	3,450,000	6,379,000

* Standardly furnished with stainless steel thermostat tube. †340X-M4Z – Temperature Relief of 210°F, Certified CSA only.

** ASME capacities are steam pressure ratings at the indicated set pressure and do not reflect the CSA temperature relieving capacity of the valves for selection purposes. Standard pressure relief setting: 75, 100, 125 and 150psi (5.2, 6.9, 8.6, and 10.3 bar).

Set @ 150psi (10.3 bar).

Series 3L, 53L (1/2", 3/4")

Poppet Type Pressure Relief Valves for Protection Against Excessive Pressure

3L – ASME rated, design certified and listed by CSA. MIL Spec MIL-V-136-10 Type 1. Size: 3/4" (20mm), NPT male inlet x NPT female (drain) outlet. ASME construction and tested, listed and certified by the National Board of Boiler and Pressure Vessel Inspectors. Pressure range 75 – 150psi (5.2 – 10.3 bar). Standard setting 75psi (5.2 bar). Optional setting 100, 125, 150psi (6.9, 8.6, 10.3 bar). Used in conjunction with Model 210 gas shutoff valve, p.17.

53 – without test lever.

- Sizes: 1/2", 3/4" (15, 20mm), NPT male inlet x NPT female (drain) outlet
- Pressure Range: 75 – 175psi (5.2 – 12.1 bar)
- Standard pressure relief setting is 75psi (5.2 bar). Optional settings 100, 125 or 150psi (6.9, 8.6, or 10.3 bar)

53L – same as Model 3L except 1/2" (15mm) inlet/outlet. Includes test lever. ANSI Z21.22 "Relief Valves for Hot Water Supply Systems". Design certified and listed by CSA. Does not comply with ASME requirements. UL Listed.

FP53L – for fire protection grid systems; protects against excessive pressure from thermal expansion or line surge. Size: 1/2" (15mm). Pressure relief set at 175psi (12.1 bar). UL Listed.

For more products to protect against thermal expansion, see pages 25 and 27.

For additional information, request literature ES-3L/53L or ES-FP53L.



3L

Series 30 (1/2")

Pressure Relief Valves

- Pressure relief only.

30L – with test lever; not diaphragm activated. Nominal size: 1/2" (15mm), NPT male inlet x female (drain) outlet. Standard Pressure Setting: 75psi (5.2 bar). Optional settings 100, 125 and 150psi (6.9, 8.6, 10.3 bar).

30L-Z1 – well system relief valve. Capacity 20 gpm (76 lpm) at 10psi (68.9kPa) over 75psi (516.7 kPa) set pressure

N30L – with test lever. Pressure Range: 30 – 60psi (206.7 – 413.4 kPa). Standard settings 30 – 45psi (206.7 – 310 kPa)

N30 – without test lever. Pressure Range: 5 – 25psi (34.5 – 172.4 kPa)

For additional information, request literature ES-30.



30L

Series 530C (1/2" – 3/4")

Calibrated Pressure Relief Valves

- Adjustable pressure relief range 50-175psi (3.4 – 12.1 bar)
- Designed for use as protection against excessive pressure build-up in systems containing water, oil and air

530FP – for fire protection systems.

Specifications

- Nominal sizes: 1/2" or 3/4" (15 – 20mm), NPT male inlet x 1/2" (15mm) NPT female (drain) outlet
- Maximum Working Pressure: 300psi (20.7 bar)
- Maximum Working Temperature: 180°F (82°C)

For additional information, request literature ES-530C.



530C

Series H32 (1/2" – 3/4")

Hose Connection Pressure Relief Valve

- Has a 3/4" hose connection inlet for ease of installation

Specifications

- Set at 80psi or 100psi (5.5 bar or 6.9 bar)

For assistance, contact your local authorized Watts agent or visit our website at www.watts.com



H32

Model 5300A (1/2")

Poppet-Type, Compact Bypass Relief Valve

- Bronze body construction
- "T" handle facilitates pressure adjustment

Specifications

- Nominal size: 1/2" (15mm), NPT male inlet x female outlet
- Pressure Range: 0 – 250psi (0 – 17.2 bar)



5300A

Series BP30 (1/2")

By-pass Control Relief Valves

- Controls liquid pressure as supplied by a positive pressure pump
- Protects equipment by operating at the desired pressure setting and allows excess volume to be bypassed back to the source

Specifications

- Size 1/2" (15mm), NPT male inlet x female outlet
- Pressure Range: 10 – 175psi (.069 – 12.1 bar)
- Maximum Temperature: 180°F (82°C)
- Bronze body, sensitive rubber diaphragm and special Teflon® disc

Models

BP30A – adjustable 10 – 50psi (68.9-344.8 kPa), Model BP30B, 45 – 100psi (310.3 – 689.5 kPa) Model BP30C 75 – 175psi (5.2 – 12.1 bar)

For additional information, request literature ES-BP30.



BP30

Spacemaker® by Watts Outside Water Heater Enclosures

- Allows water heater to be installed outdoors
- Galvanized steel enclosures

Specifications/Models

- Enclosures available for water heaters 20 to 100 gallons in size
- Three sided, back sections are also available
- No screws, nuts or bolts required

R-24 BL – for 20 – 50 gallon tank size, 24" Square x 72½" Tall

WPE-24 (1) – for 20 – 50 gallon tank size, 24" Cabinet w/o Venting or Louvers

R-26 – for 20 – 65 gallon tank size, 26" Wide x 24" Deep x 72½" Tall

R-30 BL – for 50 – 80 gallon tank size, 30" Square x 72½" Tall

C-36 Com – for 80 – 100 gallon tank size, 36" Square x 82" Tall

B-24 – 24" Back Section for R-24BL Enclosures

B-24 WPE – Back Section for WPE-24

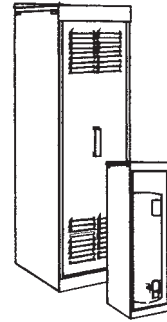

B-26 – 26" Back Section for R-26 Enclosures

B-30 – 30" Back Section for R-30BL Enclosures

B-36 – 36" Back Section for C-36 Enclosures

For additional information, request literature F-Spcmk.

Spacemaker® by Watts Water Heater Stands Series AS – Preassembled

- Raises water heater flame element 18" above the floor per safety code requirements
- Reduces risk of fire, explosion, and property damage
- Galvanized steel construction

Specifications/Models

- Stands available for water heaters 40 to 100 gallons in size.

AS-20 – for up to 52 gallon tank, Size 20" x 20" x 16"

AS-22 – for up to 65 gallon tank, Size 22" x 22" x 16"

AS-26 – for up to 75 gallon tank, Size 26" x 26" x 16"

AS-30 – for up to 100 gallon tank, Size 30" x 30" x 16"

For additional information, request literature F-Spcmk.

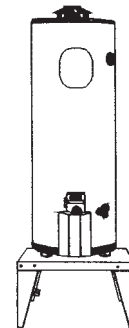

Model DPS Drip Pan Stand

- Round Stand includes built-in drip pan

Specifications/Models

- Holds up to 52 gallon water heater
- PVC drain connector
- All clip together design

DPS-20 – for up to 52 gallon tank, Size 22" x 16"

For additional information, request literature F-Spcmk.

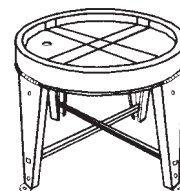

Model ENS Enclosed Stand

- For use in food processing areas
- Fully enclosed to prevent the base from being used as a storage area

Specifications/Models

- Floating seismic clips for easy bolting to the wall

ENS-20 – for up to 40 gallon tank, Size 20" x 20" x 16"

For additional information, request literature F-Spcmk.

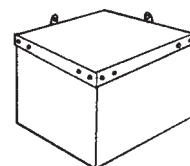

Spacemaker® by Watts Heavy-duty Water Heater Restraints Series E-50, E-100 – Double Straps for Tight Spacing

- Use for optimal security
- Specially designed for cabinets and space limited installations

Specifications/Models

- Accommodates up to 100 gallon water heater
- Double strapping system
- Cradles the tank with gussets for added security
- Fast convenient front tensioning of the restraint

E-50 – for up to 52 gallon tank. Double strapping system for tight spaces and/or cabinets where hardware needs to locate behind the water heater

E-100 – for up to 100 gallon tank. Double strapping system for tight spaces and/or cabinets where hardware needs to locate behind the water heater

For additional information, request literature F-Spcmk.

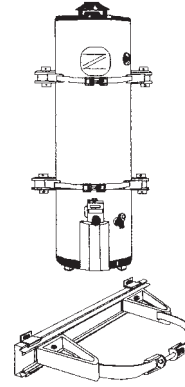

Series FS – Free Standing

- Allows safe placement of the water heater anywhere on roof or floor
- Mounts to the roof or floor by bolting straight through or with the use of a floating clip

Specifications/Models

- Accommodates up to 100 gallon water heaters
- Heavy duty angle iron frame complete with a E-100 restraint

FS-26 – for up to 65 gallon tank; super heavy duty construction for installations where no wall is available for mounting, platform is 26" square

FS-36 – for up to 120 gallon tank; super heavy duty construction for installations where no wall is available for mounting, platform is 36" square

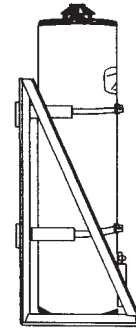

Series WM – Wall Mounted

- Allows safe placement of the water heater anywhere on the wall
- Perfect for industrial applications

Specifications/Models

- Accommodates up to 120 gallon water heaters
- Heavy duty wall mount system includes a E-100 restraint

WM-26 – for up to 65 gallon tank; super heavy duty construction for installations against the wall where the water heater needs to be elevated, platform is 26" square

WM-30 – for up to 120 gallon tank; super heavy duty construction for installations where the water heater needs to be elevated, platform is 30" square

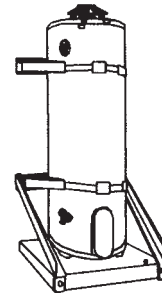

Series TSE – Water Heater Straps for Zero Clearance

- For zero clearance water heaters
- Quick easy installation – Bolts directly into wall studs
- Adjusts easily to fit water heater

Specifications/Models

- Accommodates up to 75 gallon water heater
- Kit contains four straps for restraining top and bottom of water heater
- Lag bolts are pre-installed & held with paper keepers to prevent dropping behind the tank

TSE-75 – for up to 75 gallon tank; simple double straps for across-the-front installations

TSE-75P (Plastic wrap) – same as TSE-75 except straps are packed in heavy duty polyolefin plastic shrink wrap

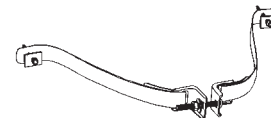

Spacemaker[®] by Watts Water Heater Restraints Series E-75, E-120 – Easy Adjust Water Heater Straps

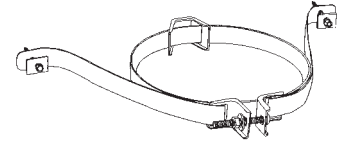

- Quick easy installation — Bolts directly into wall studs
- Adjusts easily to fit water heater

Specifications

- Accommodates up to 75 gallon water heater
- Kit contains four straps for restraining top and bottom of water heater
- Lag bolts are pre-installed & held with paper keepers to prevent dropping behind the tank

Models

E-75 – for up to 75 gallon tank. Provides great flexibility in strapping the water heater, either to wrap the water heater with a non-flammable back spacer or strap across-the front like the TSE-75

E-120 – for up to 120 gallon tank, same as the E-75 except it comes with enough strap to encircle or go across the front of a 120 gal. water heater

For additional information, request literature F-Spcmkr.

Series WDS (3/4", 1")

FloodSafe™ Water Detector Shutoff

- Series WDS Floodsafe™ Water Detector Shutoff protects the home or business owner from catastrophic damage due to a water heater leak. The Series WDS detects the presence of water on the floor (or in a drain pan) beneath the water heater and automatically shuts off the water supply and power source to the water heater. Models available for gas, electric, and oil fired water heaters.

Specifications

- Testable and Resettable: The FloodSafe™ Water Detector Shutoff can be easily reset by the contractor, home or business owner or plumbing inspector to assure proper operation.
- Easily installed on new or existing water heaters.
 - No special piping is required.
 - Supplied with a Water Dam for concrete, linoleum, tile or other hard surface flooring.
 - Sized for 3/4" or 1" (20 or 25mm) water supply lines.
 - Secure interlocking connector cables are unique to each connecting device.
 - Powered by a safe low-voltage power supply that plugs into a standard 120 VAC wall outlet and is wired using standard thermostat cable (supplied by installer).
- Employs state-of-the-art water detection technology (no terminals to corrode or to impair operation).
- Provides contacts for monitored alarm detection systems.

Mechanical

Maximum Pressure: 150psi (10.3 bar)

Maximum Temperature: 210°F (99°C)

Electrical

120 VAC, 70mA, 60Hz

Current draw: 50mA

Maximum Electric Water Heater current rating: 30A

Models

WDS-SP-L – Standing Pilot - left-hand thread

WDS-SP-R – Standing Pilot - right-hand thread

WDS-E220 – Electric - 220 VAC

WDS-SI – Spark Ignition/Oil Fired

For additional information, request literature ES-WDS.



WDS

Series TWH (3/4")

Tankless Water Heater Valves

Series TWH tankless water heater valves are designed to simplify the installation, maintenance and operation of tankless water heaters. For fast and trouble-free installation use a Series TWH to replace for unions, three tees, seven nipples, two ball valves two boiler drains, and two hose bib covers that are used in a typical tankless water heater installation.

Specifications

- 3/4" FPT unions for connection to water heater (all models)
- 3/4" FPT unions for connection to water lines (UT models)
- 3/4" Quick-Connect end connections to water lines (QT models)
- Full-port, quarter-turn ball valve with color-coded tee handle and union
- Quarter-turn purge and drain valve with hose connection and tethered brass cap
- Optional 3/4" pressure relief valve 150psi (10.3 bar)
- Optional integral spring check valve in cold water valves
- Hot and cold valves certified to NSF/ANSI 61
- Staggered connection points for ease of installation and access
- Valves are suitable for most tankless installations
- No additional adapters required
- 600 WOG rated

Models

Valve Sets

(One Hot Water and One Cold Water valve per set)

TWH-UT-HC – hot and cold water valve set, union connections

TWH-UT-HC-RV – hot and cold water valve set, union connections with relief valve

TWH-QC-HC – hot and cold water valve set, quick-connect x union end connections

TWH-QC-HC-RV – hot and cold water valve set, quick-connect x union end connections, with relief valve

TWH-UT-HCN – hot and cold water valve set, union connections, no check valve, no relief valve

TWH-UT-HCN-RV – hot and cold water valve set, union connections, no check valve, with relief valve

TWH-QC-HCN – hot and cold water valve set, quick-connect x union end connections, no check valve, no relief valve

TWH-QC-HCN-RV – hot and cold water valve set, quick-connect x union end connections, no check valve, with relief valve

Single Valves

(Hot or Cold)

TWH-UT-H – hot water shutoff valve, dual union connections

TWH-UT-C – cold water shutoff valve, integral check valve, dual union connections

TWH-UT-CN – cold water shutoff valve, dual union connections, no check valve

TWH-QC-H – hot water shutoff valve, union x quick-connect end connections

TWH-QC-C – cold water shutoff valve, integral check valve, quick-connect x union end connections

TWH-QC-CN – cold water shutoff valve, quick-connect x union end connections, no check valve

For additional information, request literature ES-TWH.

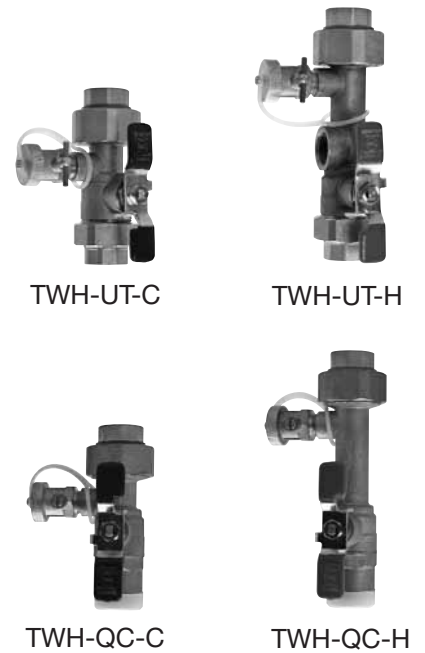

Series N36 (1/2", 3/4")

Water Service Vacuum Relief Valves

- Automatically vents a closed system if vacuum occurs
- Allows air to enter the system
- Relieves vacuum conditions which could siphon the water from the system and burn out a water heater or collapse a tank



N36

Specifications

- Maximum Working Pressure: 200psi (13.8 bar)
- Maximum Temperature: 250°F (121°C)
- Size: 1/2" or 3/4" (15 or 20mm), NPT male inlet connection. Venting capacity: 1/2" size (15mm) and 3/4" size (20mm) are 15 cfm (425 lpm)

Standards

- Design certified by CSA. Tested and rated under ANSI Z21.22 Relief Valves for Hot Water Supply Systems" CSA certified
- Also suitable for steam service, max. pressure 15psi (103.4 kPa)

Features

- Opens at less than 1/2" (15mm) vacuum

For additional information, request literature ES-N36.

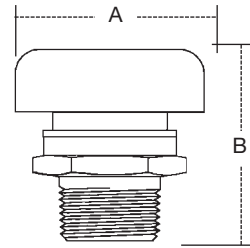

MODEL	SIZE (DN)		DIMENSIONS				WEIGHT	
	in.	mm	A		B		oz.	gr.
N36 M1	1/2	15	2	50	2	50	4	113
N360 M1	3/4	20	2	50	2	50	4	113

Series N360, N360I (1/2", 3/4")

Water Service Vacuum Relief Valves

- Automatically vents a closed system if vacuum occurs
- Allows air to enter the system
- Relieves vacuum conditions which could siphon the water from the system and burn out a water heater or collapse a tank
- Can be mounted in a vertical or horizontal position



N360



N360I

Specifications

- Maximum Working Pressure: 200psi (13.8 bar)
- Maximum Temperature: 250°F (121°C)

Standards

- Design certified by CSA. Tested and rated under ANSI Z21.22 "Relief Valves for Hot Water Supply Systems." CSA certified
- Also suitable for steam service, max. pressure 15psi (103.4 kPa)

Features

- Opens at less than 1/2" (15mm) vacuum

For additional information, request literature ES-N360/N360I.

MODEL	SIZE (DN)		DIMENSIONS			WEIGHT		
	in.	mm	A	B	C	oz.	gm.	
N360	1/2	15	1 1/2	38	2 5/16	58	9	255
N360	3/4	20	1 1/2	38	2 3/16	55	9	255
N360I	3/4 FNPT x 3/4 MNPT	20 x 20	2 3/4	70	1 7/8	48	13	369

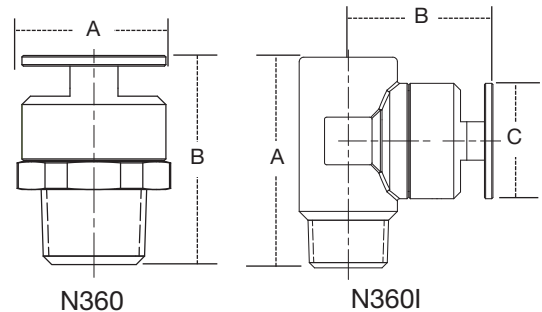

Models 100DT, 100DT-A (3/4")

Drain Lines for T&P Relief Valves

- Connects to 3/4" (20mm) temperature and pressure relief valve drain connections
- For use on T&P relief valves with up to 105,000 BTU/hr. rating
- Requires no special tools or fittings; hand tightens to relief valve outlet

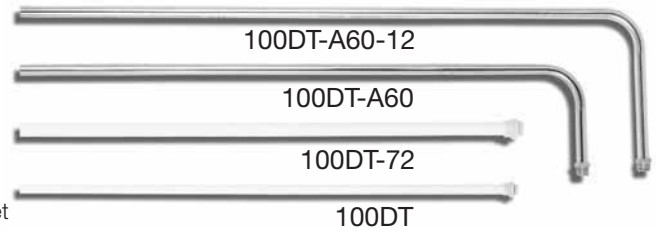

Models

- 100DT** – for use with side mounted relief valves. Drop length is 48" (1219mm)
- 100DT-72** – same as above except drop length is 72" (1829mm)
- 100DT-A60** – for use with top mounted relief valves. Drop length is 60" (1524mm)
- 100DT-A60-12** – for use with center top mounted relief valve. Drop length is 60" (1524mm)

Standards

Drain line: Fully approved ASME A112.4.1UPC, IAPMO
Meets Dept. of Housing and Urban Development requirements

For additional information, request literature ES-100DT.

Series BRV (3/4", 1")

Combination Ball Valve and Relief Valve

Specifications

- Maximum Working Temperature: 210°F (99°C)
- Maximum Working Pressure: Valve body rated to 400psi (27.6 bar)

Features

- Easy Installation – Installs in any position
- Low profile design
- Full port ball valve with virgin PTFE seats
- Blowout proof stem
- Stainless steel spring/Viton® ball relief valve components
- Secure compression or PEX end fitting drain tube connection
- Full line of pex connections
- Available in a 75, 80, 100 or 125psi (5.2, 5.5, 6.9, or 8.6 bar) pressure setting
- Available with threaded, solder or PEX end connections

For additional information, request literature ES-BRV.

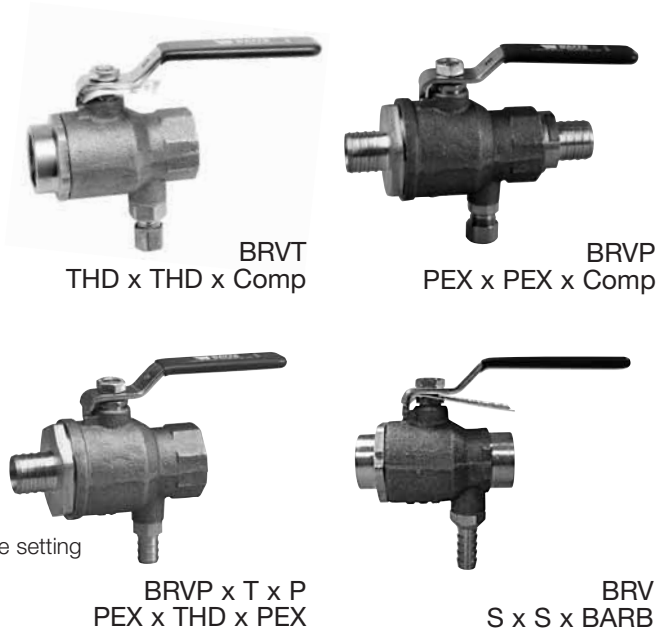

Available Models

INLET	OUTLET	RELIEF OUTLET	INLET	OUTLET	RELIEF OUTLET
Sweat	Sweat	PEX	Sweat	PEX	Compression
Sweat	Sweat	Compression	PEX	PEX	PEX
Thread	Thread	Compression	Sweat	Sweat	Barb
PEX	PEX	Compression	Thread	Thread	Barb
PEX	Thread	Compression	PEX	PEX	Barb
PEX	Thread	PEX	PEX	Sweat	Barb
PEX	Sweat	Compression	PEX	Thread	Barb
PEX	Sweat	PEX	Sweat	PEX	Barb
Thread	PEX	Compression	Thread	PEX	Barb

Series DET-M1

Potable Water Expansion Tanks for Domestic Hot Water Systems

- Controls thermal expansion of water in open domestic hot water supply systems
- Absorbs the increased volume of water generated by the hot water heating source keeping system pressure below the pressure relief setting of the T&P relief valve
- May be used with all types of direct-fired water heaters (gas, oil or electric) and all types of hot water storage tanks
- Its pre-pressurized steel tank uses an expansion membrane to prevent air/water contact for long system life

For additional information, request literature ES-DET-M1.

For information on ASME rated tanks, request literature ES-DETA.

MODEL	DET-5-M1	DET-12-M1	DET-20-M1	DET-35-M1
Max. Pressure – psi	150	150	150	150
Max. Temperature – °F	200	200	200	200
Tank Volume – Gal.	2.1	4.5	8.5	14.00
Tank Acceptance – Gal.	.85	1.8	3.2	5.6
Air Precharge – psi	40	40	40	40
Connection Size – inches†	¾ Male	¾ Male	¾ Male	1 Female
Diameter – inches	8.5	10.0	12.5	16.0
Length – inches	11.5	115.0	19.2	21.7
Weight – lbs.	7	10	15	32

† – Connection size: **(M)**=Male, **(F)**=Female.



DET-5-M1

Standards

Listed by IAPMO, Certified to ANSI/NSF61

Features

- Rugged butyl diaphragm
- In-line and free-standing models

Series DETA 5 – DETA 210

ASME Pressurized Expansion Tanks for Potable Hot Water

- Designed to accept the expanded volume of hot water keeping the system pressure below the relief valve setting
- For commercial and industrial potable hot water applications
- ASME fixed bladder type precharged expansion tank

Specifications

- Maximum Working Pressure: 150psi (10.3 bar) Precharged to 40psi (275 kPa)
- Maximum Temperature: 240°F (115°C)

For additional information, request literature ES-DETA.

Features

- ASME Section VIII Construction
- Fixed Butyl Bladder (FDA approved)
- Stainless Steel System Connection
- Precharged to 40psi (275 kPa) (Field Adjustable)

Construction

Shell: Carbon steel

System Connection: Stainless steel

Bladder: Butyl (FDA approved)

Exterior: Primer coated



DETA

Series PLT

Potable water expansion tanks

- Designed to take in water displaced by thermal expansion and to maintain balanced pressure throughout the potable water supply
- Expansion tanks for all types of Direct Fired Hot Water Heater (gas, oil or electric) and hot water storage tanks



PLT-5

Specifications

- Maximum Working Pressure: 150psi (10.3 bar)
- Maximum temperature 200°F (93°C)

For additional information, request literature ES-PLT.

MODEL	PLT-5	PLT-12
Max. Pressure – psi	150	150
Max. Temperature °F	200	200
Tank Volume – Gal	2.1	4.5
Tank Acceptance – Gal.	1.26	2.8
Air Precharge – psi	40	40
Connection Size – in.†	¾ Male	¾ Male
Diameter – inches	8	10.5
Length – inches	11	13.5
Weight – lbs.	5.5	10

† – Connection size: **(M)** = Male, **(F)** = Female.

Features

- Polypropylene liner
- Rugged flexible butyl diaphragm
- Field adjustable pre-charge
- IAPMO and NSF listed
- Can be used with most standard water heater and storage tanks

Series CWH-S (5/8" – 7/8")

Flexible, Braided Stainless Steel Water Heater Connectors

- For connecting water heaters to the water supply
- Protects against the destructive effects of system pressure surges
- PVC tubing jacketed with braided stainless steel



CWH-S-FF-L

Models

CWH-S-FF-L – Size ¾" x ¾" (20 x 20mm), brass female iron pipe (FIP) threaded ends

CWH-S-AF-L – Size 5/8" (16mm) compression end fitting x ¾" (20mm) brass FIP threaded fitting

CWH-S-AM-L – Size 7/8" (22mm) compression end fitting x ¾" (20mm) brass FIP threaded fitting

CWH-S-AA-L – Size 7/8" x 7/8" (22 x 22mm) compression end fittings

CWH-S-FM-L – Size ¾" (20mm) brass FIP thread fitting x ¾" (20mm) brass male iron pipe threaded fitting

CWHS-AM-L – Size 7/8" (22mm) compression end fitting x ¾" (20mm) brass male iron pipe threaded fitting

Specifications

Maximum Pressure: 150psi (10.3 bar)

Maximum Temperature: 180°F (82°C)

All hoses are NSF61 approved for safer drinking water

For additional information, request literature F-Flxcon.

Series PVS-1000

Pre-engineered Valve Stations

Series PVS-1000 Pre-Engineered Valve Stations are custom configured water flow control systems that are assembled from proven, reliable Watts components to meet exacting project application requirements. Watts pre-engineered valve stations are factory pre-assembled, tested and optionally certified by independent agencies to ensure flow performance for critical building demands.

Benefits

Watts pre-engineered valve stations provide the following benefits:

- Reduction of installation time from days to hours, minimizing installations costs
- Redundant flow paths provide uninterrupted water flow while device is being tested or maintained, reducing overtime labor costs
- Operates below OSHA mandated maximum noise levels
- Corrosion resistant design reduces component maintenance costs
- Optional pre-installation performance certification ensures conformance to design criteria at site
- Reduction in the number of overall components needed through Watts' innovative design program
- One supplier of components, one source of responsibility, Watts, a leader in valve technology for over 125 years

Applications

Watts pre-engineered valve stations are custom fit to your specifications and are ideal for a wide variety of flow control applications including:

- Hospitals
- Schools
- Multi-Family Dwellings
- Restaurants
- Industrial Facilities
- Other similar buildings

Features

- Maximum flow performance with low pressure drops
- Wide flow control ranges meet standard end emergency peak flow requirements
- Standard flow design to >10,000 gpm
- Integral backflow prevention devices, meter, pressure regulators, automatic control valves, strainers, headers, shutoff valves, and instrumentation as needed to suit specific applications



- UL/FM, ASSE, IAPMO, USC certified or listed components as required for service
- Single point of connection for fire protection, potable water and irrigation services (where approved by local codes)
- Standard vault, vertical, and horizontal mounting configurations
- Integral slip and alignment flanges correct for site variations and relieve pipe stress
- Field proven in over 100 installations and years of history
- Expansion capability
- Built-in protection for system upsets (i.e. seismic shocks)

For additional information, request literature PG-ValveStations.

Series BIC-1000

Backflow Irrigation Control Stations

Series BIC-1000 Backflow Irrigation Control Stations combine the master valve, regulator valve, backflow preventer, preload valve and high-pressure lockout switch all in one easily located component. Constructed using best practice design principles, these systems maximize operating performance and reduce pipe breaks and leakage within the irrigation system. Watts BIC-1000 station minimizes system-operating pressure during both the system operation as well as when there is no flow to the system to reduce water line breaks, has a single warranty policy and is pre-tested to ensure reliable operation "out of the crate".

System Attributes

- All components are above ground level on a stainless steel station
- Combines the Master Valve, Regulator Valve, and Backflow Assembly in one easily located component

Features

- **Preload Pilot.** The entire irrigation pressure piping system is maintained with a preload stand-by, field adjustable, low pressure control valve. This in combination with a higher set point on the regulator and master valve creates a buffer when turned on.
- **High-Pressure Lockout Switch.** When high pressure is detected, the switch will lock out the 24V circuit; making the system inoperable until the problem is addressed. This prevents high pressure shock and water hammer when the system is allowed to turn on.
- All components are flanged type, nut and bolt modular design for easy replacement.
- 24-hour monitoring system of the outlet pressure for excessive buildup above set operating pressure.
- Water is conserved by reducing or eliminating potential line breaks caused by high pressure. The master valve/regulator is installed at the backflow assembly which provides a shut-off and pressure control of the entire system.

For additional information, request literature F-BIC-1000.

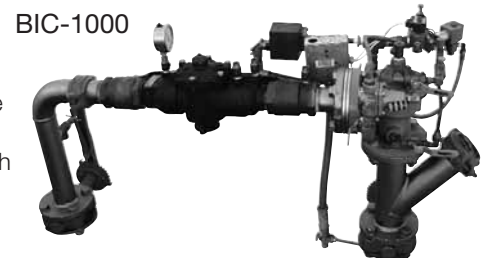

SilverEagle™ Series 757, 757N

(2½" – 10")

Double Check Valve Assemblies

- Designed to prevent backflow of pollutants that are objectionable but not toxic from entering the potable water supply
- For non-health hazard continuous pressure applications
- Provides protection against backsiphonage and backpressure backflow

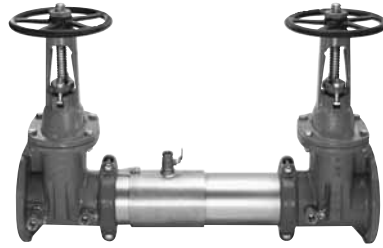

757 OSY

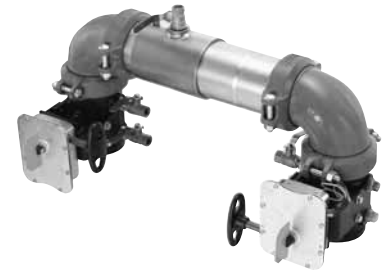

757N BFG

Specifications

- Temperature Range: 33°F – 110°F (0.5°C – 43°C)
- Maximum Working Pressure: 175psi (12.1 bar)

Models add Suffix:

NRS – non-rising stem resilient seated gate valves

OSY – UL/FM outside stem and yoke resilient seated gate valves

***OSY FxG** – flanged inlet gate connection and grooved outlet gate connection

***OSY GxF** – grooved inlet gate connection and flanged outlet gate connection

***OSY GxG** – grooved inlet gate connection and grooved outlet gate connection

BFG – 2½" – 8" UL/FM grooved gear operated butterfly valves with tamper switch

QT – 2½" – 3" quarter-turn ball valves

Available with grooved NRS gate valves - consult factory*

Post indicator plate and operating nut available – consult factory*

* Consult factory for dimensions

Features

- Extremely compact design
- 70% Lighter than traditional designs
- 304 (Schedule 40) stainless steel housing and sleeve
- Groove fittings allow integral pipeline adjustment
- Patented tri-link check provides lowest pressure loss
- Unmatched ease of serviceability
- Available with grooved butterfly valve shutoffs
- May be used for horizontal, vertical or N pattern installations
- Replaceable check disc rubber
- Sizes 2½" – 3" (65 – 80mm) available with quarter-turn ball valve shutoffs

For additional information, request literature ES-757/757N.

For WattsBox Enclosures, request literature ES-WB.

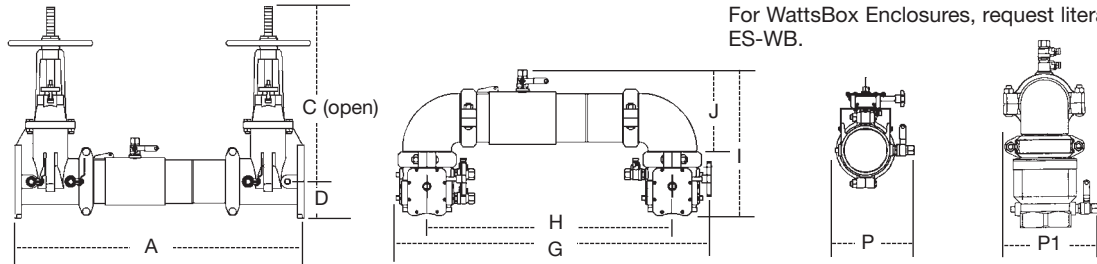

757, 757N

SIZE (DN)	DIMENSIONS (APPROX.)										WEIGHT															
	A		C (OSY)		C (NRS)		D		G		H		I		J		P		757NRS	757OSY	757N NRS	757N OSY				
in. mm	in.	mm	in.	mm	in.	mm	in.	mm	in.	mm	in.	mm	in.	mm	in.	mm	in.	mm	lbs.	kgs.	lbs.	kgs.	lbs.	kgs.		
2½ 65	31	787	16¾	416	9¾	238	3½	89	29¼	738	22	559	15½	393	8⅜	223	9¾	234	115	52	125	57	123	56	133	60
3 80	31⅜	805	18⅞	479	10¼	260	3⅜	94	30¼	768	22¾	578	17⅞	435	9⅞	233	10½	267	131	59	145	66	144	65	158	72
4 100	33⅜	856	22¾	578	12¾	310	4	102	33	838	24	610	18½	470	9⅝	252	11¾	284	161	73	161	73	184	83	184	83
6 150	43½	1105	30⅞	765	16	406	5½	140	44¾	1137	33¾	857	23¾	589	13⅞	332	15	381	273	124	295	134	314	142	336	152
8 200	50	1270	37¾	959	19⅝	506	6⅜	170	54⅞	1375	40¾	1032	27⅞	697	15⅜	399	17¾	437	438	199	480	218	513	233	555	252
10 250	57½	1460	45¾	1162	23⅝	605	8¾	208	66	1676	50	1270	32½	826	17⅞	440	20	508	721	327	781	354	891	404	951	431

757BFG, 757N BFG

SIZE (DN)	DIMENSIONS (APPROX.)										WEIGHT									
	A		C		D		G		H		I		J		P		757BFG		757N BFG	
in. mm	in.	mm	in.	mm	in.	mm	in.	mm	in.	mm	in.	mm	in.	mm	in.	mm	lbs.	kgs.	lbs.	kgs.
2½ 65	28	711	8	203	3½	89	29⅞	759	22	559	14⅝	379	8⅜	223	9	229	56	25	64	29
3 80	28½	724	8⅞	211	3⅜	94	30⅜	779	22¾	578	15⅞	392	9⅞	233	9½	241	54	24	67	30
4 100	29⅞	741	8⅝	227	3⅜	94	31⅝	811	24	610	16¼	412	9⅝	252	10	254	61	28	84	38
6 150	36½	927	10	254	5	127	43⅞	1097	33¾	857	19⅜	500	13⅞	332	10½	267	117	53	157	71
8 200	43	1092	12¼	311	6½	165	51⅞	1297	40¾	1032	23⅞	592	15⅜	399	14¾	361	261	118	337	153

757QT

SIZE (DN)	DIMENSIONS (APPROX.)										WEIGHT									
	A		C		D		G		H		I		J		P		P1			
in. mm	in.	mm	in.	mm	in.	mm	in.	mm	in.	mm	in.	mm	in.	mm	in.	mm	in.	mm	lbs.	kgs.
2½ 65	28⅝	735	4⅞	124	3⅜	97	30¼	768	24½	622	16⅞	421	11¾	289	10⅞	265	8⅞	211	35	16
3 80	30⅞	767	4⅜	122	3⅞	98	30¼	768	24½	622	17⅞	437	11¼	258	10⅞	265	8⅞	217	45	21

For assistance, contact your local authorized Watts agent or visit our website at www.watts.com

SilverEagle™ Series 757a, 757Na (2½" – 6")

Double Check Valve Assemblies

- Designed to prevent backflow of pollutants that are objectionable but not toxic for entering the potable water supply
- For non-health hazard continuous pressure applications
- Provides protection against backsiphonage and backpressure backflow

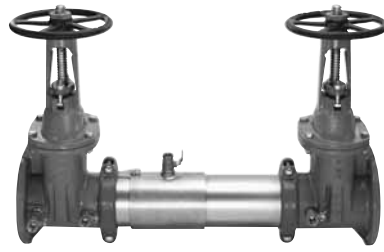

757a OSY

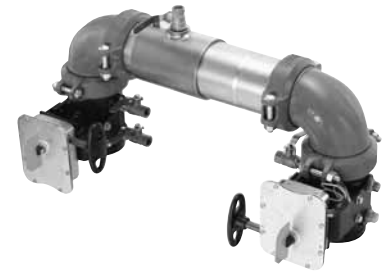

757Na BFG

Specifications

- Temperature Range: 33°F – 110°F (0.5°C – 43°C)
- Maximum Working Pressure: 175psi (12.1 bar)

Models

add Suffix:

NRS – non-rising stem resilient seated gate valves

OSY – UL/FM outside stem and yoke resilient seated gate valves

***OSY FxG** – flanged inlet gate connection and grooved outlet gate connection

***OSY GxG** – grooved inlet gate connection and flanged outlet gate connection

***OSY GxG** – grooved inlet gate connection and grooved outlet gate connection

BFG – UL/FM grooved gear operated butterfly valves with tamper switch

Available with grooved NRS gate valves - consult factory*

Post indicator plate and operating nut available – consult factory*

* Consult factory for dimensions

Features

- Extremely compact design
- 70% Lighter than traditional designs
- 304 (Schedule 40) stainless steel housing and sleeve
- Groove fittings allow integral pipeline adjustment
- Patented bi-link check provides lowest pressure loss
- Unmatched ease of serviceability
- Available with grooved butterfly valve shutoffs
- May be used for horizontal, vertical or N pattern installations
- Replaceable check disc rubber

For additional information, request literature ES-757a/757Na.

For WattsBox Enclosures, request literature ES-WB.

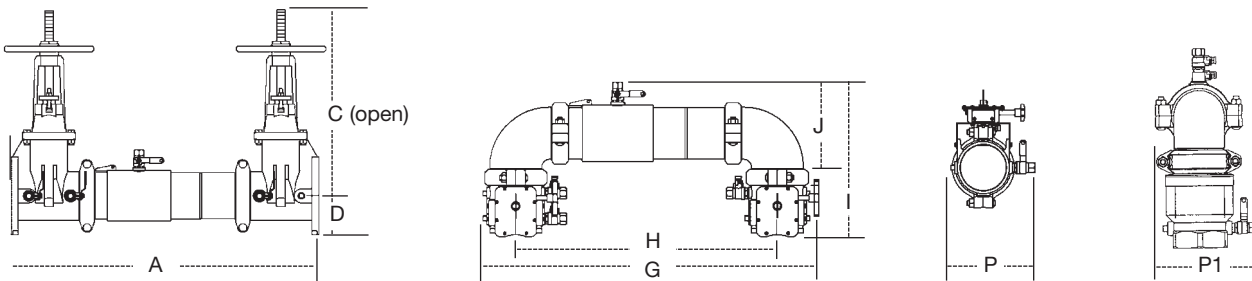

757a, 757Na

SIZE (DN)	DIMENSIONS (APPROX.)										WEIGHT															
	A		C (OSY)		C (NRS)		D		G		H		I		J		P		757a NRS	757a OSY	757Na NRS	757Na OSY				
in. mm	in.	mm	in.	mm	in.	mm	in.	mm	in.	mm	in.	mm	in.	mm	in.	mm	in.	mm	lbs.	kgs.	lbs.	kgs.	lbs.	kgs.		
2½ 65	-	-	-	-	-	-	-	-	29½/16	738	22	559	15½/8	393	8½/16	223	9¾/16	234	-	-	-	-	123	56	133	60
3 80	-	-	-	-	-	-	-	-	30¼/16	768	22¾/4	578	17¼/8	435	9¾/16	233	10½/2	267	-	-	-	-	144	65	158	72
4 100	-	-	-	-	-	-	-	-	33	838	24	610	18½/2	470	9½/16	252	11¾/16	284	-	-	-	-	184	83	184	83
6 150	43½/2	1105	30¾/8	765	16	406	5½/2	140	44¾/4	1137	33¾/4	857	23¾/16	589	13¼/16	332	15	381	273	124	295	134	314	142	336	152

Note: For 2½"-4" horizontal/vertical installation, see p. 37

757a BFG, 757Na BFG

SIZE (DN)	DIMENSIONS (APPROX.)										WEIGHT									
	A		C		D		G		H		I		J		P		757a BFG	757Na BFG		
in. mm	in.	mm	in.	mm	in.	mm	in.	mm	in.	mm	in.	mm	in.	mm	in.	mm	lbs.	kgs.	lbs.	kgs.
2½ 65	-	-	-	-	-	-	29¾/16	759	22	559	14½/16	379	8¾/16	223	9	229	56	25	64	29
3 80	-	-	-	-	-	-	30¼/16	779	22¾/4	578	15¼/16	392	9¾/16	233	9½/2	241	54	24	67	30
4 100	-	-	-	-	-	-	31½/16	811	24	610	16¼/4	412	9½/16	252	10	254	61	28	84	38
6 150	36½/2	927	10	254	5	127	43¾/16	1097	33¾/4	857	19¼/16	500	13¼/16	332	10½/2	267	117	53	157	71

Note: For 2½"-4" horizontal/vertical installation, see p. 37

Series 774 (2½" – 12")

Double Check Valve Assemblies

- Designed to prevent the reverse flow of polluted water from entering the potable water system
- For non-health hazard continuous pressure applications
- Provides protection against backsiphonage and backpressure backflow



774OSY

Specifications

- Temperature Range: 33°F – 110°F (0.5°C – 43°C)
- Maximum Working Pressure: 175psi (12.1 bar)

Models

add Suffix:

LF – without shutoff valves

NRS – non-rising stem resilient seated gate valves

OSY – UL/FM outside stem and yoke resilient seated gate valves

***OSY FxG** – flanged inlet gate connection and grooved outlet gate connection

***OSY GxG** – grooved inlet gate connection and flanged outlet gate connection

***OSY GxG** – grooved inlet gate connection and grooved outlet gate connection

S – cast iron strainer

Available with grooved NRS gate valves - consult factory*

Post indicator plate and operating nut available – consult factory*

* Consult factory for dimensions

Features

- Patented torsion spring check valve provides low head loss
- Short lay length is ideally suited for retrofit installations
- Stainless Steel body is half the weight of competitive designs reducing installation and shipping cost
- Stainless steel construction provides long term corrosion protection and maximum strength
- Single top access cover with two-bolt grooved style coupling for ease of maintenance
- Thermoplastic and stainless steel check valves for trouble-free operation
- No special tools required for servicing
- Compact construction allows for smaller vaults and enclosures
- May be installed in horizontal or vertical flow up position

For additional information, request literature ES-774.

For WattsBox Enclosures, request literature ES-WB.

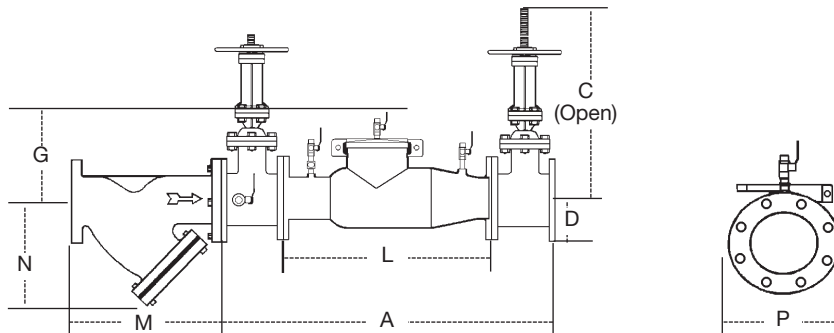

774

SIZE (DN)		DIMENSIONS (APPROX.)										STRAINER DIMENSIONS				WEIGHT							
in.	mm	A		C (OSY)		C (NRS)		D		G		L		P		M		N		w/Gates		w/o Gates	
		in.	mm	in.	mm	in.	mm	in.	mm	in.	mm	in.	mm	in.	mm	in.	mm	in.	mm	lb.	kg.	lb.	kg.
2½	65	38	965	16¾	416	9¾	238	3½	89	10	254	22	559	12½	318	10	254	6½	165	155	70	68	31
3	80	38	965	18⅞	479	10¼	260	¾	95	10	254	22	559	13	330	10½	257	7	178	230	104	70	32
4	100	40	1016	22¾	578	12¾	310	4½	114	10	254	22	559	14½	368	12⅞	308	8¼	210	225	102	58	26
6	150	48½	1232	30⅞	765	16	406	5½	140	15	381	27½	699	15½	394	18½	470	13½	343	375	170	105	48
8	200	52½	1334	37¾	959	19½	506	6¾	171	15	381	29½	749	18¼	464	21⅞	549	15½	394	561	254	169	77
10	250	55½	1410	45¾	1162	23¾	605	8	200	15	381	29½	749	19½	495	26	660	18½	470	763	346	179	81
12	300	57½	1461	53⅞	1349	26¾	679	9½	241	15	381	29½	749	21	533	29⅞	759	21¾	552	1033	469	209	95

Series 709 (2½" – 10")

Double Check Valve Assemblies

- Designed to prevent the reverse flow of polluted water from entering the potable water system
- For non-health hazard continuous pressure applications
- Provides protection against backsiphonage and backpressure backflow

Specifications

- Temperature Range: 33°F – 110°F (0.5°C – 43°C)
- Maximum Working Pressure: 175psi (12.1 bar)

For additional information, request literature ES-709L.

For WattsBox Enclosures, request literature ES-WB.



709 OSY

Features

- Replaceable bronze seats
- Maximum flow at low pressure drop
- Design simplicity for easy maintenance
- No special tools required for servicing
- Captured spring assemblies for safety
- Approved for vertical flow up installation

Models

add Suffix:

BB – bronze body. Sizes 2½" – 3"
(65 – 80mm)

S – cast iron strainer

S-FDA – epoxy coated cast iron strainer

LF – without shutoff valves

NRS – non-rising stem resilient seated gate valves

OSY – UL/FM outside stem and yoke resilient seated gate valves

QT-FDA – FDA epoxy coated quarter-turn ball valves

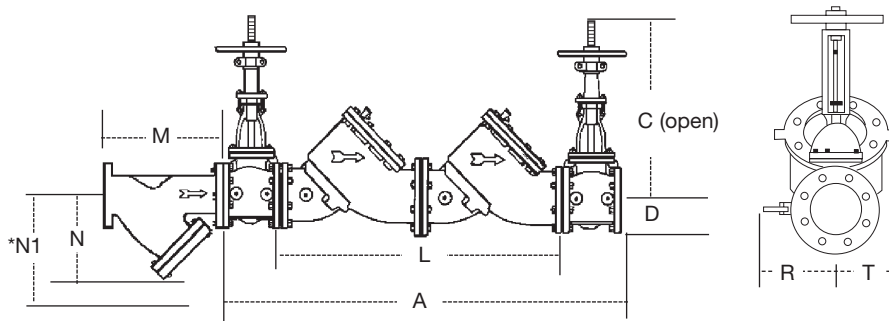

709

SIZE (DN)	DIMENSIONS (APPROX.)										STRAINER DIMENSIONS				WEIGHT										
	A		C(OSY)		C(NRS)		D		L		R		T		M		N		*N1		(OSY)		(NRS)		
in.	mm	in.	mm	in.	mm	in.	mm	in.	mm	in.	mm	in.	mm	in.	mm	in.	mm	in.	mm	in.	mm	lbs.	kgs.	lbs.	kgs.
2½	65	39	991	16¾	416	9⅞	238	3½	89	24	610	4	102	3	76	10	254	6½	165	10	254	195	88	167	76
3	80	40	1016	18⅞	479	10¼	260	3¾	95	24	610	5	127	3	76	10¼	260	7	178	10	254	201	91	167	76
4	100	52	1321	22¾	578	12¼	310	4½	114	34	864	6	152	6	152	12½	308	8¼	210	12	305	428	194	368	167
6	150	63¼	1607	30⅞	765	16	406	5½	140	42½	1089	11	279	7½	191	18½	470	13½	343	20	508	860	390	627	284
8	200	75	1905	37¾	959	19⅛	506	6⅝	168	52	1321	11¼	286	9	229	21⅝	549	15½	394	22¾	578	1448	656	1201	545
10	250	90	2286	45¾	1162	23⅜	605	8	203	64	1626	12½	318	10¼	260	26	660	18½	470	28	711	2373	1076	2003	908

*Dimensions needed for screen removal.

Series 007 (1/2" – 3")

Double Check Valve Assemblies

- Designed to prevent the reverse flow of polluted water from entering the potable water system
- For non-health hazard continuous pressure applications
- Provides protection against backsiphonage and backpressure backflow

Specifications

- Temperature Range: 1/2" – 2": 33°F – 180°F (0.5°C – 82°C); 2 1/2" – 3": 33°F – 110°F (0.5°C – 43°C) continuous, 140°F (60°C) intermittent
- Maximum Working Pressure: 175psi (12.1 bar)



007M3QT

Features

- Ease of maintenance - only one cover
- Top entry
- Replaceable seats and seat discs
- Modular construction
- Compact design
- Top mounted ball valve test cocks
- Low pressure drop
- No special tools required for servicing
- 1/2" – 1" (15 – 25 mm) have tee handles
- 1/2" – 2" (15 – 50mm) cast bronze body construction
- 2 1/2" – 3" (65 – 80mm) fused epoxy coated cast iron body

For additional information, request literature ES-007 or ES-SS007.

For WattsBox Enclosures, request literature ES-WB.

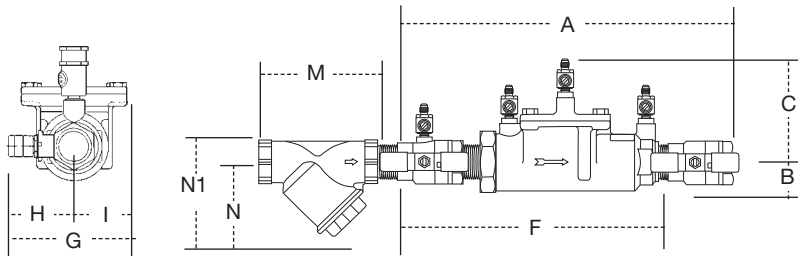

007QT

SIZE (DN)		DIMENSIONS (APPROX.)												STRAINER DIMENSIONS			WEIGHT						
in.	mm	A		B		C		F		G		H		I		M		N		*N ₁		lbs.	kgs.
1/2	15	10	254	4 5/8	117	2 7/16	62	5	127	3 3/8	85	2 5/16	59	2 1/16	52	2 3/4	70	2 1/4	57	10	254	4.5	2
3/4	20	11 1/8	282	4	102	3 1/8	79	6 3/16	157	3 7/16	87	2 1/8	54	1 5/16	33	3 3/16	81	2 3/4	70	10	254	5	2.3
1	25	13 1/4	337	5 1/8	130	4	102	7 1/2	191	3 3/8	85	1 11/16	43	1 11/16	43	3 3/4	95	3	76	12	305	12	5.4
1 1/4	32	16 3/8	416	5	127	3 3/16	84	9 1/2	241	5	127	3	76	2	50	4 7/16	113	3 1/2	89	20	508	15	6.8
1 1/2	40	16 3/4	425	4 7/8	124	3 1/2	89	9 3/4	248	5 1 3/16	148	3 1/8	79	2 1 1/16	68	4 7/8	124	4	103	22 3/4	578	15.86	7.2
2	50	19 1/2	495	6 1/4	159	4	102	13 3/8	340	6 1/8	156	3 7/16	87	2 1 1/16	68	5 5/16	151	5	127	28	711	25.75	11.7

*Dimensions required for screen removal.

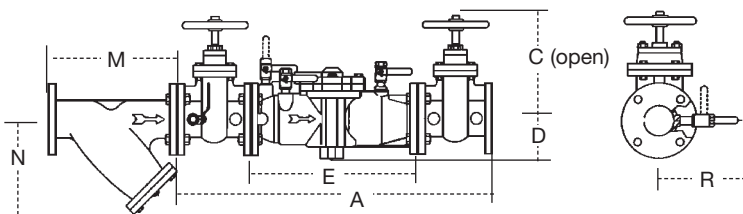

MODEL NO.	SIZE (DN)		DIMENSIONS (APPROX.)										STRAINER DIMENSIONS				WEIGHT	
	in.	mm	A		C		D		E		R		M		N		lb.	kgs.
007-NRS	2 1/2	65	33 3/8	841	9 5/8	238	4 5/16	109	18 1/8	460	8 3/4	222	10	254	6 1/2	165	155	70
007-OSY	2 1/2	65	33 3/8	841	16 3/8	416	4 5/16	109	18 1/8	460	8 3/4	222	10	254	6 1/2	165	158	72
007QT-FDA	2 1/2	65	33 3/8	841	6 3/8	162	4 5/16	109	18 1/8	460	8 3/4	222	10	254	6 1/2	165	155	70
007-OSY	3	80	34 1/8	867	18 7/8	479	4 5/16	109	18 1/8	460	8 3/4	222	10 1/8	267	7	178	185	84
007-NRS	3	80	34 1/8	867	10 1/4	260	4 5/16	109	18 1/8	460	8 3/4	222	10 1/8	267	7	178	185	84
007QT-FDA	3	80	34 1/8	867	6 3/8	162	4 5/16	109	18 1/8	460	8 3/4	222	10 1/8	267	7	178	155	70

GoldenEagle® Series 719 (1/2" – 2")

Double Check Valve Assemblies

- Designed to protect drinking water supplies from dangerous cross-connections in accordance with national plumbing codes and water authority requirements
- For non-health hazard continuous pressure applications
- Provides protection against backsiphonage and backpressure backflow



719QT

Features

- Manufactured from bronze alloy
- Separate access, top entry check valve design
- Reversible seat disc rubber, extends check valve life
- Chloramine resistant elastomers
- Replaceable seats and seat discs
- Compact design
- Top mounted screwdriver slotted ball valve test cocks
- Low pressure drop
- 1/2" – 1" (15 – 25mm) have Tee handles
- No special tools required for servicing
- Plastic on plastic check guiding reduces potential binding due to mineral deposits

Specifications

Temperature Range: 33°F – 180°F (0.5°C – 82°C)

Maximum Working Pressure: 175psi (12.1 bar)

Models

add Suffix:

S – bronze strainer

LF – without shutoff valves

LH – locking handle ball valves

SH – stainless steel ball valve handles

HC – 2 1/2" inlet/outlet fire hydrant fittings (2" valve)

QT – quarter-turn ball valves

C&T – testcock caps and tethers

add Prefix:

U – union connections

AQT – street elbows with quarter-turn ball valves

For additional information, request literature ES-719

For WattsBox Enclosures, request literature ES-WB

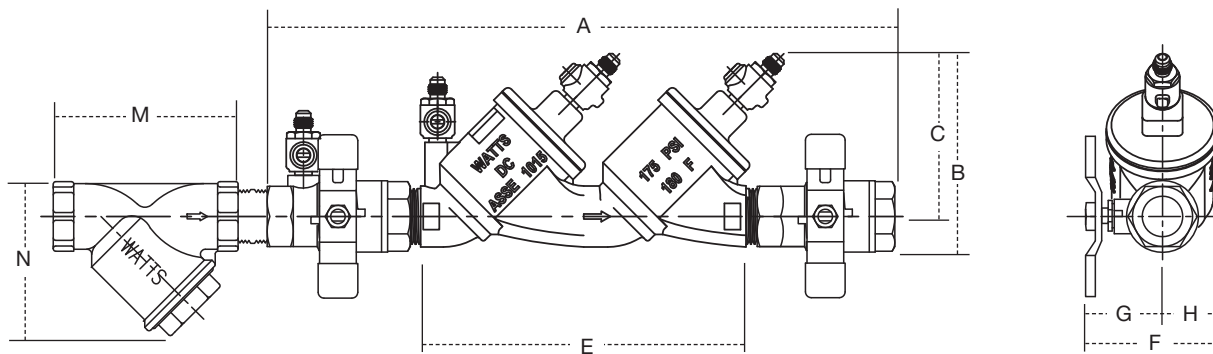

719QT

SIZE	DIMENSIONS (APPROX.)										STRAINER DIMENSIONS				WEIGHT						
	A		B		C		E(LF)		F		G		H		M		N		lbs.	kgs.	
in.	mm	in.	mm	in.	mm	in.	mm	in.	mm	in.	mm	in.	mm	in.	mm	in.	mm	in.	mm		
1/2	15	9 7/8	251	3 11/16	94	2 5/16	75	5 3/4	147	2 1/2	63	1 11/16	43	3/4	20	2 1/4	57	2 3/4	70	2.84	1.29
3/4	20	12 3/8	314	4 1/4	108	3 1/2	90	7 7/8	200	3 3/8	80	2 1/16	53	1 1/16	27	2 3/4	70	3 3/16	81	4.66	2.11
1	25	14 13/16	376	4 9/16	116	3 13/16	98	9 5/8	244	3 13/16	96	2 7/16	63	1 5/16	34	3	76	3 3/4	95	7.44	3.37
1 1/4	32	18 7/8	480	6 1/8	155	5 1/16	129	11 11/16	297	4 1/4	108	2 5/8	67	1 5/8	41	3 1/2	89	4 7/16	113	13.96	6.33
1 1/2	40	18 7/8	480	6 1/8	155	5 1/16	129	11 11/16	297	4 3/4	120	3 1/8	79	1 5/8	41	4	102	4 7/8	124	16.12	7.31
2	50	21 3/16	538	7 1/16	179	5 13/16	147	13 3/8	340	5 5/16	136	3 7/16	87	1 15/16	49	5	127	5 5/16	151	25.66	11.64

SilverEagle™ Series 757DCDA, 757NDCDA (2½" – 10")

Double Check Detector Assemblies



757DCDA OSY



757DCDA BFG

- Designed to prevent backflow of pollutants that are objectionable but not toxic for entering the potable water supply
- For non-health hazard continuous pressure applications
- Provides protection against backsiphonage and backpressure backflow
- Primarily installed on fire sprinkler systems when it is necessary to monitor unauthorized use of water



757NDCDA OSY

Specifications

- Temperature Range: 33°F – 110°F (0.5°C – 43°C)
- Maximum Working Pressure: 175psi (12.1 bar)

Models

add Suffix:

OSY – UL/FM outside stem and yoke resilient seated gate valves

BFG – 2½" - 8" (65 – 200mm) UL/FM grooved gear operated butterfly valves with tamper switch

CFM – cubic feet per minute meter

GPM – gallons per minute meter

***OSY FxG** – flanged inlet gate connection and grooved outlet gate connection

***OSY GxF** – grooved inlet gate connection and flanged outlet gate connection

***OSY GxG** – grooved inlet gate connection and grooved outlet gate connection

Available with grooved NRS gate valves - consult factory*

Post indicator plate and operating nut available – consult factory*

* Consult factory for dimensions

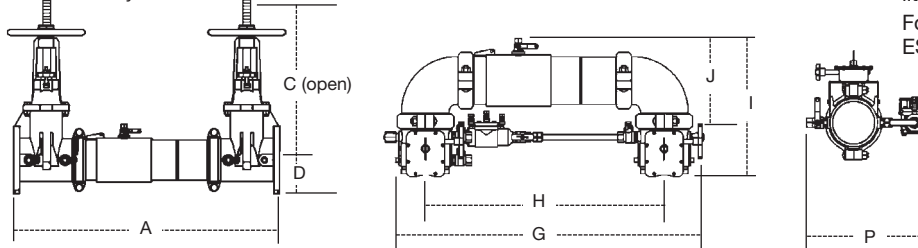

757DCDA, 757NDCDA

SIZE (DN)		DIMENSIONS (APPROX.)														WEIGHT					
in.	mm	A		C		D		G		H		I		J		P		757DCDA		757NDCDA	
		in.	mm	in.	mm	in.	mm	in.	mm	in.	mm	in.	mm	in.	mm	in.	mm	lbs.	kgs.	lbs.	kgs.
2½	65	31	787	16⅜	416	3½	89	29⅞	738	22	559	15½	393	8⅜	223	13⅜	335	139	63	147	67
3	80	31⅞	805	18⅞	479	3⅞	94	30¼	768	22¾	578	17⅞	435	9⅞	233	14½	368	159	72	172	78
4	100	33⅞	856	22¾	578	4	102	33	838	24	610	18½	470	9⅞	252	15⅜	386	175	79	198	90
6	150	43½	1105	30⅞	765	5½	140	44¾	1137	33¾	857	23⅞	589	13⅞	332	19	483	309	140	350	159
8	200	50	1270	37¾	959	6⅞	170	54⅞	1375	40⅞	1032	27⅞	697	15⅞	399	21⅞	538	494	224	569	258
10	250	57½	1460	45¾	1162	8⅞	208	66	1676	50	1270	32½	826	17⅞	440	24	610	795	361	965	438

757DCDA BFG, 757NDCDA BFG

SIZE (DN)		DIMENSIONS (APPROX.)										WEIGHT									
in.	mm	A		C		D		G		H		J		P		757DCDA BFG		757NDCDA BFG			
		in.	mm	in.	mm	in.	mm	in.	mm	in.	mm	in.	mm	in.	mm	lbs.	kgs.	lbs.	kgs.		
2½	65	28	711	8	203	3½	89	29⅞	759	22	559	14⅞	379	8⅜	223	13	330	70	32	78	35
3	80	28½	724	8⅞	211	3⅞	94	30⅞	779	22¾	578	15⅞	392	9⅞	233	13½	343	68	31	81	37
4	100	29⅞	741	8⅞	227	3⅞	94	31⅞	811	24	610	16¼	412	9⅞	252	14	356	75	34	98	44
6	150	36½	927	10	254	5	127	43⅞	1097	33¾	857	19⅞	500	13⅞	332	14½	368	131	59	171	78
8	200	43	1092	12¼	311	6½	165	51⅞	1297	40⅞	1032	23⅞	592	15⅞	399	18⅞	462	275	125	351	159

SilverEagle™ Series 757aDCDA, 757NaDCDA (2½" – 10")

Double Check Detector Assemblies



757aDCDA OSY



757aDCDA BFG



757NaDCDA OSY

- Designed to prevent backflow of pollutants that are objectionable but not toxic for entering the potable water supply
- For non-health hazard continuous pressure applications
- Provides protection against backsiphonage and backpressure backflow
- Primarily installed on fire sprinkler systems when it is necessary to monitor unauthorized use of water

Specifications

- Temperature Range: 33°F – 110°F (0.5°C – 43°C)
- Maximum Working Pressure: 175psi (12.1 bar)

Models add Suffix:

OSY – UL/FM outside stem and yoke resilient seated gate valves

BFG – UL/FM grooved gear operated butterfly valves with tamper switch

CFM – cubic feet per minute meter

GPM – gallons per minute meter

***OSY FxG** – flanged inlet gate connection and grooved outlet gate connection

***OSY GxF** – grooved inlet gate connection and flanged outlet gate connection

***OSY GxG** – grooved inlet gate connection and grooved outlet gate connection

Available with grooved NRS gate valves - consult factory*

Post indicator plate and operating nut available – consult factory*

* Consult factory for dimensions

For additional information, request literature ES-757aDCDA/757NaDCDA.

For WattsBox Enclosures, request literature ES-WB.

Features

- Extremely compact design
- 70% Lighter than traditional designs
- 304 (Schedule 40) stainless steel housing and sleeve
- Groove fittings allow integral pipeline adjustment
- Patented bi-link check provides lowest pressure loss
- Unmatched ease of serviceability
- Available with grooved butterfly valve shutoffs
- May be used for horizontal, vertical or N pattern installations
- Replaceable check disc rubber

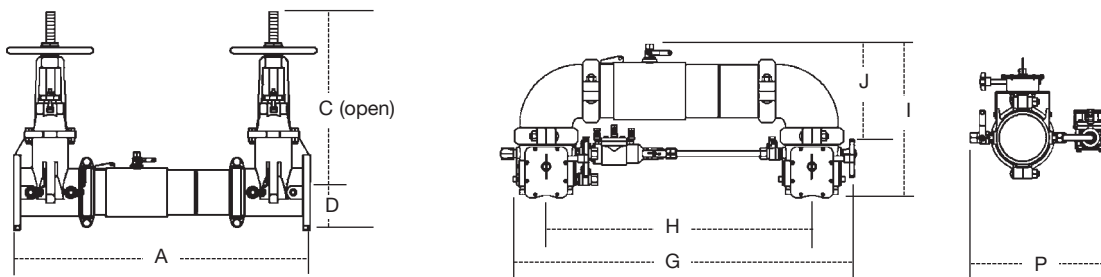

757aDCDA, 757NaDCDA

SIZE (DN)		DIMENSIONS (APPROX.)												WEIGHT							
in.	mm	A		C		D		G		H		I		J		P		757aDCDA		757NaDCDA	
		in.	mm	in.	mm	in.	mm	in.	mm	in.	mm	in.	mm	in.	mm	in.	mm	lbs.	kgs.	lbs.	kgs.
2½	65	31	787	16¾	416	3½	89	29¼	738	22	559	15½	393	8¾	223	13¾	335	139	63	147	67
3	80	31⅛	805	18⅞	479	3⅛	94	30¼	768	22¾	578	17⅞	435	9¾	233	14½	368	159	72	172	78
4	100	33⅛	856	22¾	578	4	102	33	838	24	610	18½	470	9⅝	252	15¾	386	175	79	198	90
6	150	43½	1105	30⅞	765	5½	140	44¾	1137	33¾	857	23¾	589	13¼	332	19	483	309	140	350	159

757aDCDA BFG, 757NaDCDA BFG

SIZE (DN)		DIMENSIONS (APPROX.)												WEIGHT							
in.	mm	A		C		D		G		H		I		J		P		757aDCDA BFG		757NaDCDA BFG	
		in.	mm	in.	mm	in.	mm	in.	mm	in.	mm	in.	mm	in.	mm	in.	mm	lbs.	kgs.	lbs.	kgs.
2½	65	28	711	8	203	3½	89	29⅞	759	22	559	14⅝	379	8¾	223	13	330	70	32	78	35
3	80	28½	724	8⅝	211	3⅛	94	30⅛	779	22¾	578	15⅞	392	9¾	233	13½	343	68	31	81	37
4	100	29⅞	741	8⅝	227	3⅛	94	31⅝	811	24	610	16¼	412	9⅝	252	14	356	75	34	98	44
6	150	36½	927	10	254	5	127	43⅞	1097	33¾	857	19⅛	500	13¼	332	14½	368	131	59	171	78

Series 774DCDA (2½" – 12")

Double Check Detector Assemblies

- Designed to prevent the reverse flow of polluted water from entering the potable water system
- For non-health hazard continuous pressure applications
- Provides protection against backsiphonage and backpressure backflow
- Detects system leaks or unauthorized use of the water supply

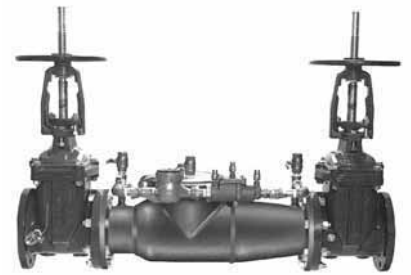

774DCDA OSY

Specifications

- Temperature Range: 33°F – 110°F (0.5°C – 43°C)
- Maximum Working Pressure: 175psi (12.1 bar)

Models

add Suffix:

CFM – cubic feet per minute meter

GPM – gallons per minute meter

LF – without shutoff valves

OSY – UL/FM outside stem and yoke resilient seated gate valves

***OSY FxG** – flanged inlet gate connection and grooved outlet gate connection

***OSY GxF** – grooved inlet gate connection and flanged outlet gate connection

***OSY GxG** – grooved inlet gate connection and grooved outlet gate connection

Available with grooved NRS gate valves - consult factory*

Post indicator plate and operating nut available – consult factory*

* Consult factory for dimensions

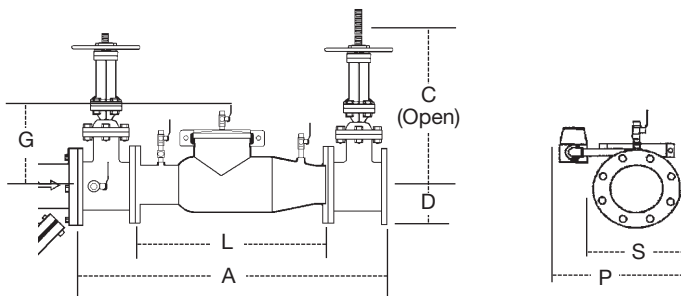

774DCDA

SIZE (DN)		DIMENSIONS (APPROX.)										WEIGHTS					
in.	mm	A		C (OSY)		D		G		L		P		w/Gates		w/o Gates	
		in.	mm	in.	mm	in.	mm	in.	mm	in.	mm	in.	mm	lb.	kgs.	lb.	kgs.
2½	65	38	965	16⅞	416	3½	89	10	254	22	559	12½	318	155	70	68	31
3	80	38	965	18⅞	479	3¾	95	10	254	22	559	13	330	230	104	70	32
4	100	40	1016	22¾	578	4½	114	10	254	22	559	14½	368	240	109	73	33
6	150	48½	1232	30⅞	765	5½	140	15	381	27½	699	15½	394	390	177	120	54
8	200	52½	1334	37¾	959	6¾	171	15	381	29½	749	18¼	464	572	259	180	82
10	250	55½	1410	45¾	1162	8	200	15	381	29½	749	19½	495	774	351	190	86
12	300	57½	1461	53⅞	1349	9½	241	15	381	29½	749	21	533	1044	474	220	100

Features

- Patented torsion spring check valve provides low head loss
- Short lay length is ideally suited for retrofit installations
- Stainless steel body is half the weight of competitive designs reducing installation and shipping cost
- Stainless steel construction provides long term corrosion protection and maximum strength
- Single top access cover with two-bolt grooved style coupling for ease of maintenance
- Thermoplastic and stainless steel check valves for trouble-free operation
- No special tools required for servicing
- Compact construction allows for smaller vaults and enclosures
- Furnished with ⅝" x ¾" bronze meter (gpm or cfm)
- Detects underground leaks and unauthorized water use
- May be installed in horizontal or vertical flow up position

For additional information, request literature ES-774DCDA.

For WattsBox Enclosures, request literature ES-WB.

Series 709DCDA (3" – 10")

Double Check Detector Assemblies

- Designed to prevent the reverse flow of polluted water from entering the potable water system.
- For non-health hazard continuous pressure applications
- Provides protection against backsiphonage and backpressure backflow
- Detects system leaks or unauthorized use of the water supply

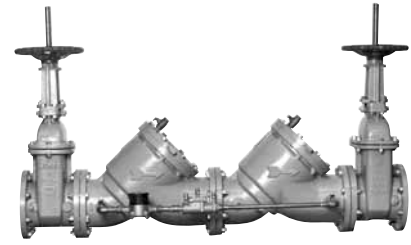

709DCDA OSY

Specifications

- Temperature Range: 33°F – 110°F (0.5°C – 43°C)
- Maximum Working Pressure: 175psi (12.1 bar)

Models

add Suffix:

OSY – UL/FM outside stem & yoke resilient seated gate valves

CFM – cubic feet per minute meter

GPM – gallons per minute meter

LF – without shutoff valves

For additional information, request literature ES-709DCDA.

For WattsBox Enclosures, request literature ES-WB.

Features

- Body construction fused epoxy coated cast iron
- Replaceable bronze seats
- Maximum flow at low pressure drop
- Compact for economy combined with performance
- Design simplicity for easy maintenance
- Furnished with 5/8" x 3/4" (16 x 19mm) meter Model 25, bronze
- No special tools required for servicing

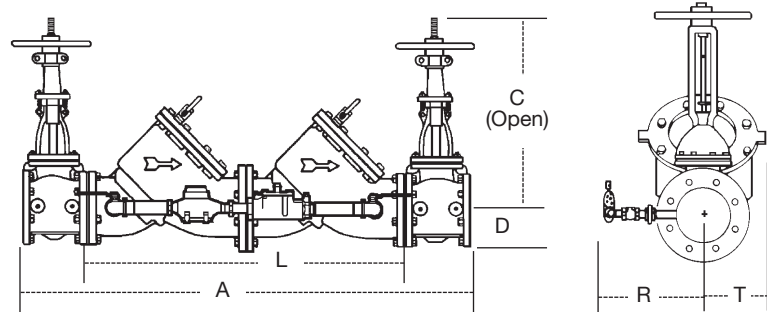

709DCDA

SIZE (DN)		DIMENSIONS (APPROX.)										WEIGHT			
		A		C		D		L		R		T			
<i>in.</i>	<i>mm</i>	<i>in.</i>	<i>mm</i>	<i>in.</i>	<i>mm</i>	<i>in.</i>	<i>mm</i>	<i>in.</i>	<i>mm</i>	<i>in.</i>	<i>mm</i>	<i>in.</i>	<i>mm</i>	<i>lbs.</i>	<i>kgs.</i>
3	80	40	1016	18 ⁷ / ₈	479	3 ³ / ₄	95	24	610	14	356	3	76	190	86
4	100	52	1321	22 ³ / ₄	578	4 ¹ / ₂	114	34	864	15	381	6	152	403	183
6	150	63 ¹ / ₄	1607	30 ¹ / ₈	765	5 ¹ / ₂	140	42 ¹ / ₄	1073	16	406	7 ¹ / ₂	191	727	330
8	200	75	1905	37 ³ / ₄	959	6 ⁵ / ₈	168	52	1321	17	432	9	229	1327	602
10	250	90	2286	45 ³ / ₄	1162	8	203	64	1626	18	457	10 ¹ / ₄	260	2093	949

Series 007DCDA (2" – 3")

Double Check Detector Assemblies

- Designed to prevent the reverse flow of polluted water from entering the potable water system
- For non-health hazard continuous pressure applications
- Provides protection against backsiphonage and backpressure backflow
- Detects system leaks or unauthorized use of the water supply



007DCDA

Specifications

- Temperature Range: 33°F – 110°F (0.5°C – 43°C) continuous; 140°F (60°C) intermittent
- Maximum Working Pressure: 175psi (12.1 bar)

Models

add Suffix:

OSY – UL/FM outside stem & yoke resilient seated gate valves

CFM – cubic feet per minute meter

GPM – gallons per minute meter

LF – without shutoff valves

For additional information, request literature ES-007DCDA.
For WattsBox Enclosures, request literature ES-WB.

Features

- Fused epoxy coated cast iron unibody (2½" & 3")
- Replaceable bronze seats
- Maximum flow at low pressure drop
- Compact for ease of installation
- Design simplicity for easy maintenance
- No special tools required for servicing
- Bronze body ball valve test cocks
- Modular spring loaded checks
- Furnished with bronze 5/8" x 3/4" (16 x 19mm) meter

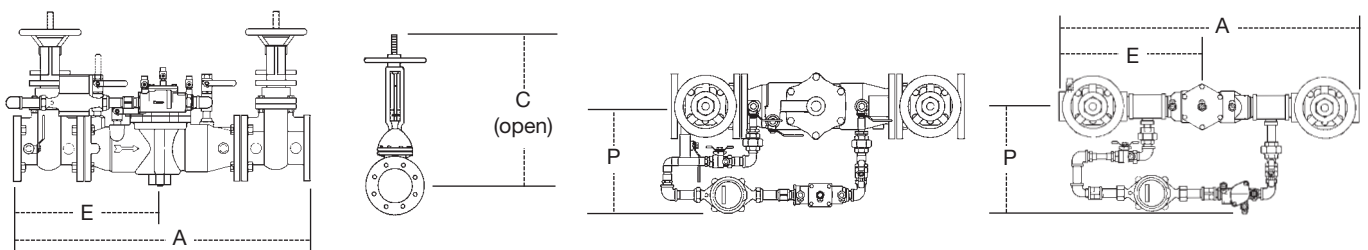

007DCDA

SIZE (DN)		DIMENSIONS (APPROX.)								WEIGHT	
<i>in.</i>	<i>mm</i>	A		C (OSY)		E		P		<i>lbs.</i>	<i>kgs.</i>
		<i>in.</i>	<i>mm</i>	<i>in.</i>	<i>mm</i>	<i>in.</i>	<i>mm</i>	<i>in.</i>	<i>mm</i>		
2	50	35½	892	13½	343	16¾	279	12¼	311	97	44
2½	65	33¼	844	16¾	416	16¾	416	12⅝	313	164	74
3	80	34¼	870	18⅞	479	15⅝	422	12⅝	313	196	89

SilverEagle™ Series 957, 957N, 957Z (2½" – 10")

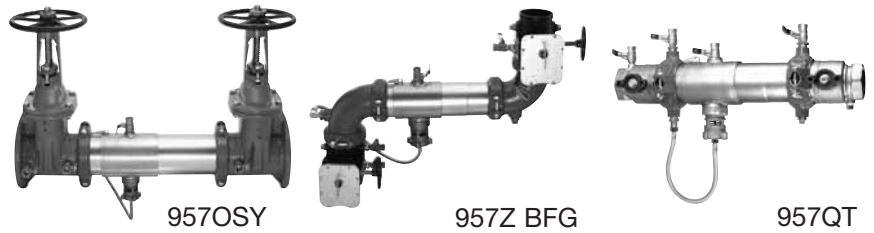

Reduced Pressure Zone Assemblies

- Designed to provide protection to the potable water system from contamination in accordance with national plumbing codes
- For health hazard continuous pressure applications
- Provides protection against backpressure and backsiphonage backflow

Specifications

- Temperature Range: 33°F – 110°F (0.5°C – 43°C)
- Maximum Working Pressure: 175psi (12.1 bar)

Models add suffix:

NRS – non-rising stem resilient seated gate valves

OSY – UL/FM outside stem and yoke resilient seated gate valves

BFG – 2½" - 6" (65 – 150mm) UL/FM grooved gear operated butterfly valves with tamper switch

QT – 2½" – 3" (65 – 80mm) quarter-turn ball valves

***OSY FxG** – flanged inlet gate connection and grooved outlet gate connection

***OSY GxG** – grooved inlet gate connection and flanged outlet gate connection

***OSY GxG** – grooved inlet gate connection and grooved outlet gate connection

Available with grooved NRS gate valves - consult factory*

Post indicator plate and operating nut available – consult factory*

* Consult factory for dimensions

Features

- Sizes 2½" – 3" (65 - 80mm) available with quarter-turn ball valve shutoffs
- Extremely compact design
- 70% Lighter than traditional designs
- 304 (Schedule 40) stainless steel housing and sleeve
- Groove fittings allow integral pipeline adjustment
- Patented torsion spring checks provides lowest pressure loss
- Unmatched ease of serviceability
- Available with grooved butterfly valve shutoffs
- May be used for horizontal, N pattern or Z pattern installations
- Bottom mounted cast stainless steel relief valve
- Replaceable check disc rubber

For additional information, request literature ES-957/957N/957Z. For information on Air Gaps, Vent Elbows and Test Cocks see page 58 or request literature ES-AG/EL/TC. For Wattsbox Enclosures, request literature ES-WB.

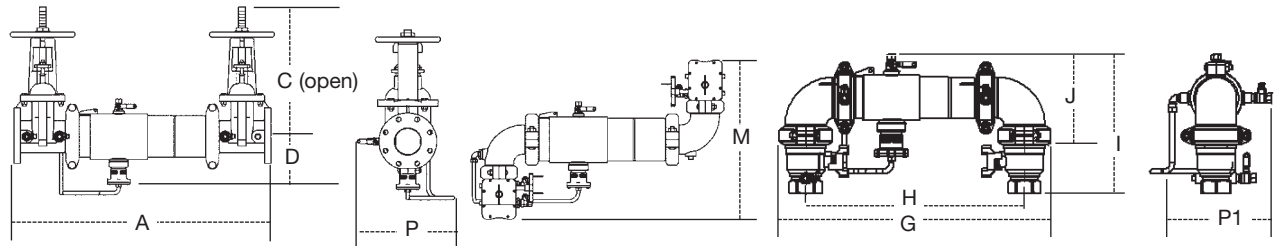

SIZE (DN)	DIMENSIONS (APPROX.)										WEIGHT																	
	A		C (OSY)		C (NRS)		D		G		H		I		J		M		P		957 (NRS)	957 (OSY)	957N (NRS)	957N (OSY)				
in. mm	in.	mm	in.	mm	in.	mm	in.	mm	in.	mm	in.	mm	in.	mm	in.	mm	in.	mm	in.	mm	lbs.	kgs.	lbs.	kgs.	lbs.	kgs.	lbs.	kgs.
2½ 65	31	787	16¾	416	9¾	238	6½	165	29¼	738	22	559	15½	393	8¼	223	21¼	548	9¾	234	118	54	128	58	126	57	136	62
3 80	31¼	805	18¾	479	10¼	260	6¼	170	30¼	768	22¾	578	17¾	435	9¼	233	23¼	587	10½	267	134	61	148	67	147	67	161	68
4 100	33¼	856	22¾	578	12¾	310	7	178	33	838	24	610	18½	470	9¼	252	26½	673	11¼	284	164	74	164	74	187	85	187	85
6 150	43½	1105	30¾	765	16	406	8½	216	44¾	1137	33¾	857	23¾	589	13¼	333	32¾	832	15	381	276	125	298	135	317	144	339	154
8 200	50	1270	37¾	959	19¼	506	9¼	246	54¾	1375	40¾	1032	27¼	697	15¼	399	37¾	943	17¼	437	441	200	483	219	516	234	558	253
10 250	57½	1460	45¾	1162	23¼	605	11¾	285	66	1676	50	1270	32¼	826	17¾	440	46¾	1178	20	508	723	328	783	355	893	405	950	431

957 BFG

SIZE (DN)	DIMENSIONS (APPROX.)										WEIGHT					
	G		H		I		J		M		P		957N BFG/957Z BFG			
in. mm	in.	mm	in.	mm	in.	mm	in.	mm	in.	mm	in.	mm	in.	mm	lbs.	kgs.
2½ 65	32½	826	23½	597	15½	394	9½	241	21¼	555	11¼	300	67	30		
3 80	34	864	24½	622	16¼	414	10¼	256	23¼	587	12¼	308	70	32		
4 100	35¾	905	26	660	17¼	437	10¼	279	24¼	634	12¾	321	87	39		
6 150	46½	1181	35¼	908	20½	521	13½	343	28¼	718	15	382	160	73		

957QT

SIZE (DN)	DIMENSIONS (APPROX.)										WEIGHT											
	A		C		D		G		H		I		J		M		P		P1		957QT	
in. mm	in.	mm	in.	mm	in.	mm	in.	mm	in.	mm	in.	mm	in.	mm	in.	mm	in.	mm	in.	mm	lbs.	kgs.
2½ 65	28¼	735	4¾	124	6¾	174	30¼	768	24½	622	16¼	421	11¾	289	20¼	532	11¼	287	11¼	287	46	21
3 80	30¾	767	4¼	122	6¾	174	30¼	768	24½	622	17¼	437	11¼	258	22¼	564	11¼	287	11¼	287	56	25

Series 994 (2½" – 10")

Reduced Pressure Zone Assemblies

- Designed to prevent the reverse flow of polluted water from entering the potable water system
- For health hazard continuous pressure applications
- Provides protection against backsiphonage and backpressure backflow

Specifications

- Temperature Range: 33°F – 110°F (0.5°C – 43°C) continuous; 140°F (60°C) intermittent
- Maximum Working Pressure: 175psi (12.1 bar)

Models

add suffix:

LF – without shutoff valves

NRS – non-rising stem resilient seated gate valves

OSY – UL/FM outside stem & yoke resilient seated gate valve

***OSY FxG** – flanged inlet gate connection and grooved outlet gate connection

***OSY GxF** – grooved inlet gate connection and flanged outlet gate connection

***OSY GxG** – grooved inlet gate connection and grooved outlet gate connection

S – cast iron strainer.

Available with grooved NRS gate valves - consult factory*

Post indicator plate and operating nut available – consult factory*

* Consult factory for dimensions

For additional information, request literature ES-994.

For information on Air Gaps, Vent Elbows and Test Cocks, see page 58 or request literature ES-AG/EL/TC.

For WattsBox Enclosures, request literature ES-WB.

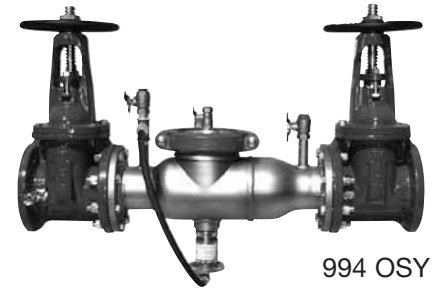

994 OSY

Features

- Stainless steel construction provides long term corrosion resistance and maximum strength
- Stainless steel body is half the weight of competitive designs reducing installation and shipping costs
- Short end to end dimensions makes retrofit easy
- Bottom mounted relief valve reduces clearance requirements when installed against an outside wall
- Patented torsion spring check valves provide maximum flow at low pressure drop
- Thermoplastic & stainless steel check valves for trouble-free operation
- No special tools required for servicing
- Compact construction allows for smaller enclosures
- Stainless steel relief valve features a balanced rolling diaphragm to eliminate sliding seals and lower maintenance costs

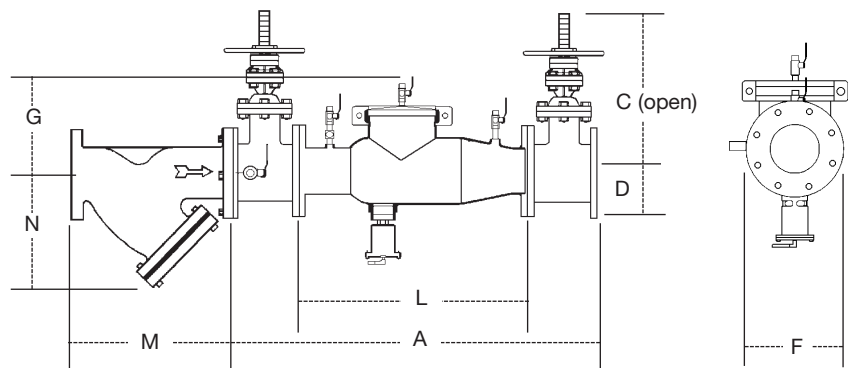

994

SIZE (DN)	DIMENSIONS (APPROX.)																WEIGHT				
	A		C (NRS)		C (OSY)		D		F		G		L		M		N		w/Gates		w/o Gates
in. mm	in. mm	in. mm	in. mm	in. mm	in. mm	in. mm	in. mm	in. mm	in. mm	in. mm	in. mm	in. mm	in. mm	in. mm	in. mm	in. mm	in. mm	in. mm	lbs. kgs.	lbs. kgs.	lbs. kgs.
2½ 65	37 940	9⅞ 238	16⅞ 416	10½ 267	7 178	10 254	22 559	10 254	6½ 165	148 67	60 27										
3 80	38 965	10¼ 260	18⅞ 479	10½ 267	7½ 191	10 254	22 559	10⅞ 257	7 178	226 103	62 28										
4 100	40 1016	12⅜ 310	22¾ 578	10½ 267	9 229	10 254	22 559	12⅞ 308	8¼ 210	235 107	65 30										
6 150	48½ 1232	16 406	30⅞ 765	11½ 292	11 279	15 381	27½ 699	18½ 470	13½ 343	380 172	110 50										
8 200	52½ 1334	19⅝ 506	37¾ 959	12½ 318	13½ 343	15 381	29½ 749	21⅝ 549	15½ 394	571 259	179 81										
10 250	55½ 1410	23⅜ 605	45¾ 1162	12½ 318	16 406	15 381	29½ 749	26 660	18½ 470	773 351	189 86										

Series 994 BLT (2½" FNPT x 3" MNPT)

Series 994 HMB (2½"-7NST x 3")

Hydrant Meter Backflow Preventers

- Designed to retrofit backflow protection of potable water from fire hydrants or other non-permanent, temporary water service connections where flow is in one direction only and the possibility of cross-connection exists
- Large flow capacity-rated at over 500gpm with less than 14psi (96.5 kPa) loss per ASSE, USC and AWWA standards for Reduced Pressure Principle devices
- Meets AWWA C701 meter requirements (Series HMB)
- Ideal for use with existing hydrant meter hookups (Series BLT)

Specifications

- Typical Operating Range: (100% +/- 1.5%) 5 to 660gpm
- Maximum Continuous Flow: 450gpm (1710 lpm)
- Maximum Intermittent Flow: 660gpm (2510 lpm)
- Typical Low Flow (Min 95%): 4gpm (15 lpm)
- Pressure Loss at Max. Flow: 37psi @ 450gpm (255 kPa @ 1710 lpm)
- Continuous Operation: 23psi @ 350gpm (159 kPa @ 1330 lpm)

Options (BLT Series)

Inlet Modules

- 3" (80mm) female or male hydrant thread
- 2½" (65mm) female or male hydrant thread
- 2½" (65mm) male NPT thread
- Customer specified

Outlet Modules

- 3" (80mm) gate w/female or male hose thread
- 2½" (65mm) gate w/ female or male hose thread
- 3" (80mm) gate valve only, w/3" (80mm) INPT thread
- 2½" (65mm) gate valve only, w/2½" (65mm) FNPT
- Customer specified

Foot Modules

- Uneven surface saddle (supplied standard with unit)
- Flat surface adapter
- Customer specified

For additional information on the HMB, request literature S-994HMB; on the BLT, request literature ES-994BLT.

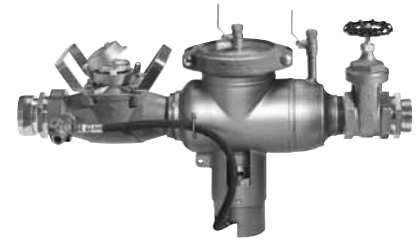

994HMB

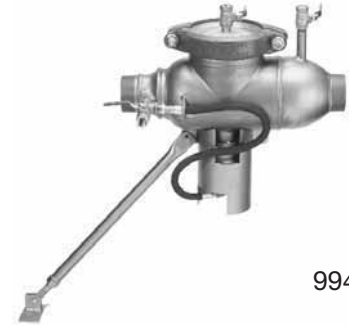

994BLT

Features

- Heavy duty relief valve cover prevents vandalism and protects valve from damage when 994HMB is transported to another fire hydrant location
- In-line flow restrictor protects the meter measuring element and the backflow preventer components from damage due to excessive flow (994HMB only)
- Backflow preventer made from 300 Series stainless steel for corrosion resistance
- Portable, lightweight design makes device easily transportable between job sites
- Accurately measures flow (HMB series) and protects the water supply from possible contamination
- Built-in support leg is adjustable in the field, no matter the installation
- Factory assembled and tested; no field assembly required; eliminates leaks, fouls, and improper assembly

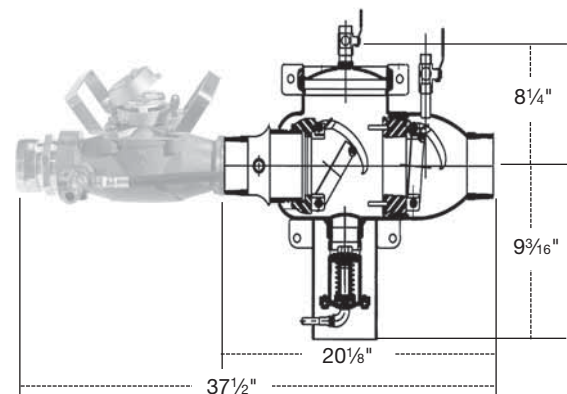

MODEL	WEIGHT	
	lbs.	kgs.
994BLT	62	28
994HMB-GPM	66	30
994HMB-CFM	66	30

Series 909 (3/4" – 2")

Reduced Pressure Zone Assemblies

- Designed to prevent the reverse flow of polluted water from entering the potable water system
- For health hazard continuous pressure applications
- Unique patented "air-in/water-out" design provides high capacity relief valve discharge performance during emergency conditions of backsiphonage and backpressure with both checks fouled

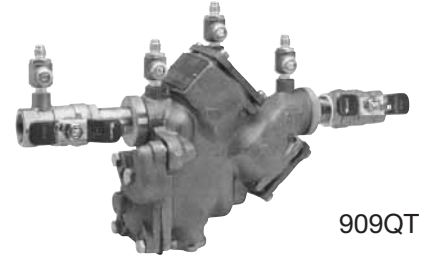

909QT

Specifications

- Temperature Range: 33°F – 140°F (0.5°C – 60°C) continuous; 180°F (82°C) intermittent
- Maximum Working Pressure: 175psi (12.1 bar)

Models

add Suffix:

QT – quarter-turn ball valves

S – bronze strainer

HW – stainless steel check modules for hot and harsh water conditions

LF – without shutoff valves

LH – locking handle ball valves (open position)

HC – inlet/outlet fire hydrant fitting (2" (50mm) only)

PC – polymer coating

Prefix

C – clean and check strainer - 3/4" and 1" only (20 and 25mm)

U – union connections - 3/4" and 1" only (20 and 25mm)

FAE – flanged adapter ends - 1 1/4", 1 1/2", 2" only (32, 40, 50mm)

For additional information, request literature ES-909S.

For information on Air Gaps, Vent Elbows and Test Cocks see page 58 or request literature ES-AG/EL/TC.

For WattsBox Enclosures, request literature ES-WB.

Features

- Modular design
- Replaceable bronze seats
- Compact for installation ease
- Horizontal or vertical (up or down) installation
- No special tools required for servicing

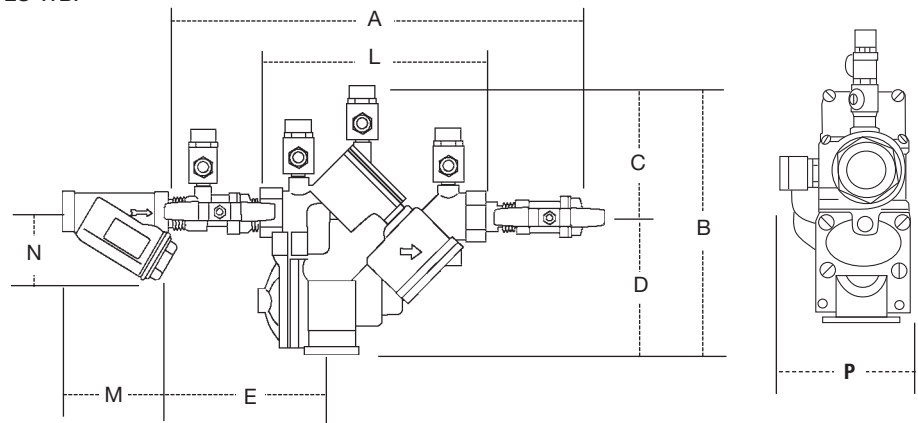

909

SIZE (DN)		DIMENSIONS (APPROX.)												STRAINER DIMENSIONS				WEIGHT			
in.	mm	A		B		C		D		E		L		P		M		N		lbs.	kgs.
		in.	mm	in.	mm	in.	mm	in.	mm	in.	mm	in.	mm	in.	mm	in.	mm	in.	mm		
3/4	20	14 3/8	365	8 3/4	222	4	102	4 3/4	121	6 3/4	171	7 5/16	186	3 7/8	98	3 3/16	81	2 3/4	70	14	6
1	25	15 3/8	391	8 3/4	222	4	102	4 3/4	121	7	178	7 5/16	186	3 7/8	98	3 3/4	95	3	76	15	7
1 1/4	32	18 1/2	470	11 5/8	295	5 1/2	140	6 1/2	165	7 1/2	191	10 3/8	264	5 1/4	133	4 7/16	113	3 1/2	89	40	18
1 1/2	40	19	483	11 5/8	295	5 1/2	140	6 1/2	165	7 1/2	191	10 3/8	264	5 1/4	133	4 7/8	124	4	102	40	18
2	50	19 1/2	495	11 5/8	295	5 1/2	140	6 1/2	165	7 3/4	197	10 3/8	264	5 1/4	133	5 5/16	151	5	127	40	18

Series 909 (2½" – 10")

Reduced Pressure Zone Assemblies

- Designed to prevent the reverse flow of polluted water from entering the potable water system
- For health hazard continuous pressure applications
- Unique patented "air-in/water-out" design provides high capacity relief valve discharge performance during emergency conditions of backsiphonage and backpressure with both checks fouled

Specifications

- Temperature Range: 33°F – 110°F (0.5°C – 43°C) continuous; 140°F (60°C) intermittent
- Maximum Working Pressure: 175psi (12.1 bar)

For additional information, request literature ES-909L.

For information on Air Gaps, Vent Elbows and Test Cocks see page 58 or request literature ES-AG/EL/TC.

For WattsBox Enclosures, request literature ES-WB.

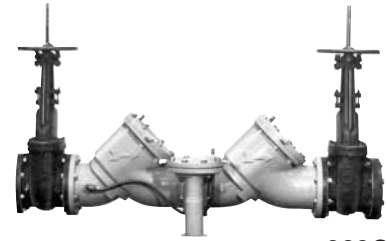

909OSY

Models

add Suffix:

BB – Bronze body, sizes 2½" & 3" (65 and 80mm)

LF – without shutoff valves

NRS – non-rising stem resilient seated gate valves

OSY – UL/FM outside stem and yoke resilient seated gate valves

QT – quarter-turn ball valve

QT-FDA – FDA epoxy coated quarter-turn ball valve shutoffs

S – cast iron strainer

S-FDA – FDA epoxy coated strainer

Features

- Replaceable bronze seats
- Stainless steel internal parts
- No special tools required for servicing
- Captured spring check assemblies
- Fused epoxy coated & lined checks
- Industrial strength sensing hose
- Field reversible relief valve
- Air-in/water-out relief valve design provides maximum capacity during emergency conditions

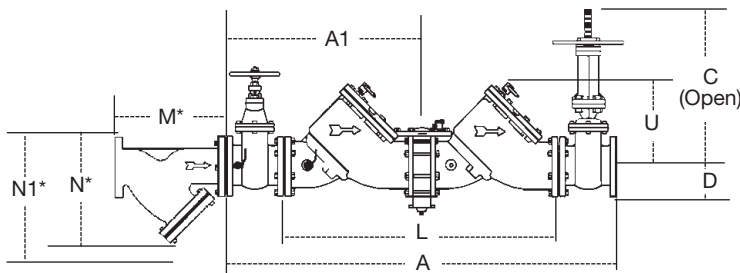

Strainer Dimensions

SIZE (DN)		DIMENSIONS (APPROX.)						WEIGHT	
		M		N1†		N			
in.	mm	in.	mm	in.	mm	in.	mm	lbs.	kgs.
2½	65	10	254	10	254	6½	165	28	12.7
3	80	10½	257	10	254	7	178	34	15.4
4	100	12½	308	12	305	8¼	210	60	27
6	150	18½	470	20	508	13½	343	133	60
8	200	21½	549	22¾	578	15½	394	247	112
10	250	26	660	28	711	18½	470	370	168

† – Dimension required for screen removal

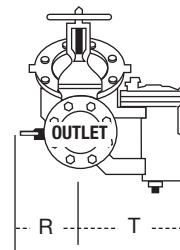

909

SIZE (DN)		DIMENSIONS (APPROX.)											WEIGHT														
		A		A1		C (OSY)*		C (NRS)		D	L	clearance for check U	R	R (QT)	T	NRS		OSY		QT							
in.	mm	in.	mm	in.	mm	in.	mm	in.	mm	in.	mm	in.	mm	in.	mm	in.	mm	in.	mm	in.	mm						
2½	65	41¼	1048	20½	524	16¾	416	9¾	238	5¼	133	26½	663	11	279	4	102	16	406	9¼	230	195	88.4	198	89.8	182	82.6
3	80	42¼	1073	21¼	540	18¾	479	10¼	260	5¼	133	26½	663	11	279	5	127	16	406	9¼	230	225	102	230	104	190	86
4	100	55½	1400	27¾	702	22¾	578	12¾	310	6	152	37	940	14	356	6	152	19¾	502	14¾	365	455	206	470	213	352	160
6	150	65½	1664	32¼	832	30¾	765	16	406	6	152	44½	1130	16	406	11	279	26	660	14¾	365	718	326	798	362	762	346
8	200	78½	2000	39¾	1000	37¼	959	19½	506	9¼	248	55¼	1403	21	533	11¼	286	11¼	286	19¼	489	1350	612	1456	660	2286	1037
10	250	93¾	2378	46¾	1190	45¼	1162	23¾	605	9¼	248	67¾	1711	21	533	12½	318	12½	318	21	533	2160	980	2230	1011	3716	1685

*UL, FM approved backflow preventers must include UL/FM approved OSY gate valves.

Series 009 (1/4" – 3")

Reduced Pressure Zone Assemblies

- Designed to prevent the reverse flow of polluted water from entering the potable water system
- For health hazard continuous pressure applications
- Provides protection against backsiphonage and backpressure backflow



009QT

Specifications

- Temperature Range: 1/4" – 2" 33°F – 180°F (0.5°C – 82°C); 2 1/2" – 3" 33°F – 110°F (0.5°C – 43°C) continuous, 140°F (60°C)
- Maximum Working Pressure: 175psi (12.1 bar)

For additional information, request literature ES-009.

For information on Air Gaps, Vent Elbows and Test Cocks see page 58 or request literature ES-AG/EL/TC.

For WattsBox Enclosures, request literature ES-WB.

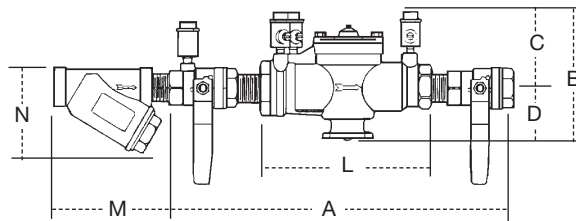

Features

- Single access cover and modular check construction for ease of maintenance
- Top entry - all internals immediately accessible
- Captured springs for safe maintenance
- Internal relief valve for reduced installation clearances
- Replaceable seats for economical repair
- Bronze body construction for durability 1/4" – 2" (8 – 50mm)
- Fused epoxy coated cast iron body - 2 1/2" and 3" (65 and 80mm)
- Ball valve test cocks - screwdriver slotted - 1/4" – 2" (8 – 50mm)
- Large body passages provide low pressure drop
- Compact, space saving design
- No special tools required for servicing

009 1/4" – 2"

SIZE (DN)		DIMENSIONS (APPROX.)										STRAINER DIMENSIONS				WEIGHT	
in.	mm	A		B		C		D		L		M		N		lbs.	kgs.
		in.	mm	in.	mm	in.	mm	in.	mm	in.	mm	in.	mm	in.	mm		
1/4	8	10	254	4 5/8	117	3 3/8	86	1 1/4	32	5 1/2	140	2 3/8	60	2 1/2	64	5	2
3/8	10	10	254	4 5/8	117	3 3/8	86	1 1/4	32	5 1/2	140	2 3/8	60	2 1/2	64	5	2
1/2	15	10	254	4 5/8	117	3 3/8	86	1 1/4	32	5 1/2	140	2 3/4	70	2 1/4	57	5	2
3/4	20	10 3/4	273	5	127	3 1/2	89	1 1/2	38	6 3/4	171	3 3/16	81	2 3/4	70	6	3
1	25	16 3/4	425	5 1/2	140	3	76	2 1/2	64	9 1/2	241	3 3/4	95	3	76	12	5
1 1/4	32	17 3/8	441	6	150	3 1/2	89	2 1/2	64	11 3/8	289	4 7/16	113	3 1/2	89	15	6
1 1/2	40	17 7/8	454	6	150	3 1/2	89	2 1/2	64	11 1/8	283	4 7/8	124	4	102	16	7
2	50	21 3/8	543	7 3/4	197	4 1/2	114	3 1/4	83	13 1/2	343	5 15/16	151	5	127	30	13

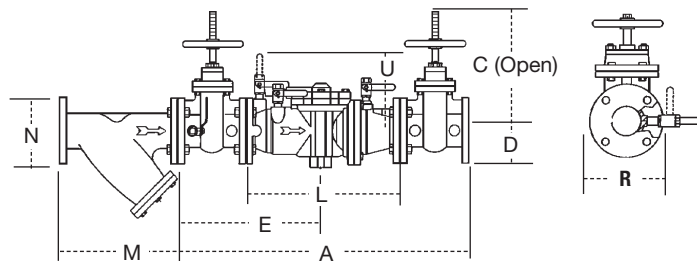

009 2 1/2" and 3"

MODEL NO.	SIZE (DN)		DIMENSIONS (APPROX.)										STRAINER DIMENSIONS				WEIGHT					
	in.	mm	A		C		D		E		L		in.	mm	N		lbs.	kgs.				
		in.	mm	in.	mm	in.	mm	in.	mm	in.	mm	in.	mm	in.	mm	in.	mm					
009LF	2 1/2	65	—	—	—	—	5 1/4	133	—	—	18 3/8	460	—	—	10 5/8	270	10	254	6 1/2	165	76	34
009OSY	2 1/2	65	33 3/4	845	16 3/8	416	5 1/4	133	16 3/8	416	18 3/8	460	7 3/4	197	10 5/8	270	10	254	6 1/2	165	166	75
009NRS	2 1/2	65	33 3/4	845	9 3/8	238	5 1/4	133	16 3/8	416	18 3/8	460	7 3/4	197	10 5/8	270	10	254	6 1/2	165	189	86
009QT	2 1/2	65	33 3/4	845	6	152	5 1/4	133	16 3/8	416	18 3/8	460	7 3/4	197	10 5/8	270	10	254	6 1/2	165	150	68
009LF	3	80	—	—	—	—	5 1/4	133	—	—	18 3/8	460	—	—	10 5/8	270	10 1/8	257	7	178	76	34
009OSY	3	80	34 1/4	870	18 7/8	470	5 1/4	133	16 5/8	422	18 3/8	460	8 3/4	222	10 5/8	270	10 1/8	257	7	178	198	90
009NRS	3	80	34 1/4	870	10 1/4	260	5 1/4	133	16 5/8	422	18 3/8	460	8 3/4	222	10 5/8	270	10 1/8	257	7	178	191	87
009QT	3	80	34 1/4	870	7	178	5 1/4	133	16 5/8	422	18 3/8	460	8 3/4	222	10 5/8	270	10 1/8	257	7	178	158	71

GoldenEagle® Series 919 (1/4" – 2")

Reduced Pressure Zone Assemblies

- Designed to prevent the reverse flow of polluted water from entering the potable water system
- For health hazard continuous pressure applications
- Provides protection against backsiphonage and backpressure backflow

Specifications

- Temperature Range: 33°F – 180°F (0.5°C – 82°C)
- Maximum Working Pressure: 175psi (12.1 bar)

Models 1/4" – 2" (8 – 50mm)

add Suffix:

QT – quarter-turn ball valves

S – bronze strainer

LF – without shutoff valves

AQT – elbow fitting for 360° rotation

ZQT – inlet & outlet flow up

add Prefix:

U – union connections

For additional information, request literature ES-919.

For information on Air Gaps, Vent Elbows and Test Cocks see page 58 or request literature ES-AG/EL/TC.

For WattsBox Enclosures, request literature ES-WB.

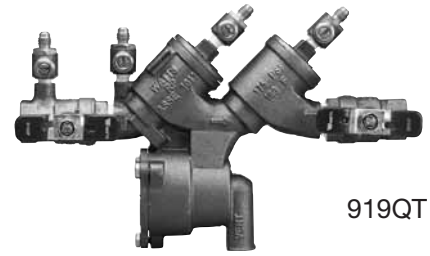

919QT

Features

- Separate access covers for the check valves and relief valve for ease of maintenance
- Top entry-all check internals easily accessible
- All rubber elastomers of chloramine resistant material
- Check valve poppet assemblies are fully guided by innovative plastic seat guide
- Replaceable push-in check valve and relief valve seats eliminates threads from the water way
- EZ twist relief valve cover quarter-turn locking joint captures the spring load during repair to facilitate disassembly
- Innovative check valve plastic cover bushing provides trouble free guiding of the check valve poppet
- Bottom mounted relief valve provides reduced installation clearances
- Compact, space saving design
- No special tools required for servicing
- Top mounted test cocks for ease in testing and reduced installation clearances
- Standardly furnished with NPT body connections

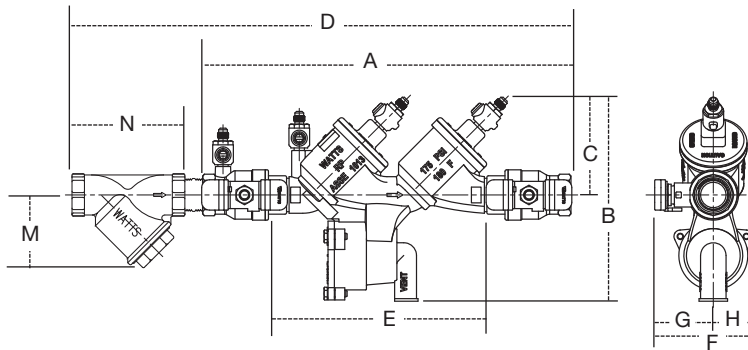

919QT, 919QT-S

SIZE (DN)	DIMENSIONS (APPROX.)										STRAINER DIMENSIONS		WEIGHT														
	A		B		C		D		E (LF)		F		G		H		M		N		919QT		919QT-S				
in.	mm	in.	mm	in.	mm	in.	mm	in.	mm	in.	mm	in.	mm	in.	mm	in.	mm	in.	mm	in.	mm	in.	mm	lbs.	kgs.	lbs.	kgs.
1/4"	8	9 1/2	241	6 7/8	175	2 7/8	73	12 3/8	314	5 3/4	146	3	75	1 3/8	35	1 1/16	40	2 3/8	60	2 1/2	64	5.8	2.6	6.3	2.9		
3/8"	10	9 1/2	241	6 7/8	175	2 7/8	73	12 3/8	314	5 3/4	146	3 1/3	84	1 3/4	44	1 1/16	40	2 3/8	60	2 1/2	64	5.8	2.6	6.3	2.9		
1/2"	15	9 1/2	241	6 7/8	175	2 7/8	73	12 3/4	324	5 3/4	146	3 3/8	86	1 7/8	48	1 1/16	40	2 3/4	70	2 1/4	57	5.8	2.6	6.3	2.9		
3/4"	20	12 1/8	307	7 7/16	188	3 1/2	88	15 1/2	393	7 11/16	195	3 5/8	92	2 1/16	52	1 1/16	40	1 5/8	41	3 3/16	81	8.3	3.7	10.0	4.5		
1"	25	14 1/2	368	8	202	3 7/8	98	19 9/16	487	9 3/16	233	4	102	2 7/16	62	1 1/16	40	2 1/8	54	3 3/4	95	11.8	5.4	13.8	6.3		
1 1/4"	32	18 1/8	461	11 7/16	290	5 1/8	129	23 1/4	591	11 11/16	297	5 1/8	130	2 5/8	67	2 1/2	64	2 1/2	64	4 7/16	113	22.3	10.1	26.3	11.9		
1 1/2"	40	18 3/4	476	11 7/16	290	5 1/8	129	25 1/16	637	11 11/16	297	5 5/8	143	3 1/8	79	2 1/2	64	3	76	4 7/8	124	28.3	12.8	32.0	14.5		
2"	50	21 1/16	535	12 1/16	307	5 5/8	142	28 13/16	732	13 3/8	340	5 15/16	151	3 7/16	87	2 1/2	64	3 9/16	90	5 15/16	151	37.3	16.9	45.0	20.4		

SilverEagle™ Series 957RPDA, 957NRPDA, 957ZRPDA (2½" – 10")

Reduced Pressure Detector Assemblies

- Designed to provide protection to the potable water system from contamination in accordance with national plumbing codes
- For health hazard continuous pressure applications
- Provides protection against backsiphonage and backpressure backflow
- Primarily installed on fire sprinkler systems when it is necessary to monitor unauthorized use of water

Specifications

- Temperature Range: 33°F – 110°F (0.5°C – 43°C)
- Maximum Working Pressure: 175psi (12.1 bar)

Models

add Suffix:

OSY – UL/FM outside stem and yoke resilient seated gate valves

BFG – 2½" – 6" N or Z pattern only with UL/FM grooved gear operated butterfly valves with tamper switch

CFM – cubic feet per minute meter

GPM – gallons per minute meter

For additional information, request literature ES-957RPDA/957NRPDA/957ZRPDA.

For information on Air Gaps, Vent Elbows and Test Cocks see page 58 or request literature ES-AG/EL/TC.

For WattsBox Enclosures, request literature ES-WB.



957NRPDA OSY

Features

- Extremely compact design
- 70% Lighter than traditional designs
- 304 (Schedule 40) stainless steel housing and sleeve
- Groove fittings allow integral pipeline adjustment
- Patented torsion spring checks provides lowest pressure loss
- Unmatched ease of serviceability
- Available with grooved butterfly valve shutoffs.
- Bottom mounted cast stainless steel relief valve
- Replaceable check disc rubber
- Metered bypass to detect leakage or theft of water from the fire sprinkler system

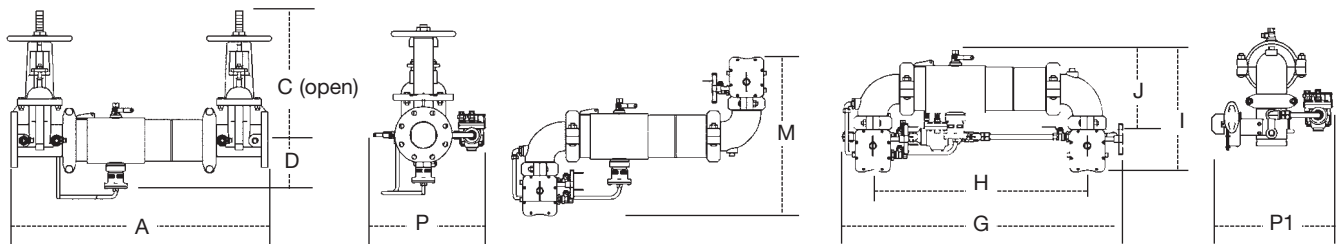

957RPDA OSY

SIZE (DN)	DIMENSIONS (APPROX.)														WEIGHT								
	A		C		D		G		H		I		J		M		P		957RPDA OSY		957NRPDA OSY		
in.	mm	in.	mm	in.	mm	in.	mm	in.	mm	in.	mm	in.	mm	in.	mm	in.	mm	in.	mm	lbs.	kgs.	lbs.	kgs.
2½	65	31	787	16⅜	416	6½	165	29⅛	738	22	559	15½	393	8⅜	223	21⅞	548	13⅜	335	142	64	150	68
3	80	31⅛	805	18⅞	479	6⅞	170	30¼	768	22¾	578	17⅞	435	9⅞	233	23⅞	587	14½	368	162	73	175	79
4	100	33⅛	856	22¾	578	7	178	33	838	24	610	18½	470	9⅞	252	26½	673	15⅜	386	178	81	201	91
6	150	43½	1105	30⅞	765	8½	216	44¾	1137	33¾	857	23⅜	589	13⅞	332	32¾	832	19	483	312	142	353	160
8	200	50	1270	37¾	959	9⅞	246	54⅞	1375	40⅞	1032	27⅞	697	15⅞	399	37⅞	943	21⅜	538	497	225	572	259
10	250	57½	1460	45¾	1162	11¾	285	66	1676	50	1270	32½	826	17⅞	440	46⅞	1178	24	610	797	362	964	437

957RPDA BFG

SIZE (DN)	DIMENSIONS (APPROX.)										WEIGHT				
	G		H		I		J		M		P1		957RPDA BFG		
in.	mm	in.	mm	in.	mm	in.	mm	in.	mm	in.	mm	in.	mm	lbs.	kgs.
2½	65	32½	826	23½	597	15½	394	9½	241	21⅜	555	15⅜	402	81	37
3	80	34	864	24½	622	16⅞	414	10⅞	256	23⅞	587	16⅞	410	84	38
4	100	35⅞	905	26	660	17⅞	437	10⅞	279	24⅞	634	16⅞	422	101	46
6	150	46½	1181	35⅞	908	20½	521	13½	343	28¼	718	19	483	174	79

Series 994RPDA (2½" – 6")

Reduced Pressure Detector Assemblies

- Designed to prevent the reverse flow of polluted water from entering the potable water system
- For health hazard continuous pressure applications
- Provides protection against backsiphonage and backpressure backflow
- Detects system leaks or unauthorized use of water supply

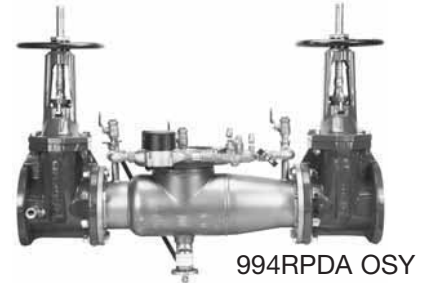

Specifications

- Temperature Range: 33°F – 110°F (0.5°C – 43°C)
- Maximum Working Pressure: 175psi (12.1 bar)

Models

add Suffix:

LF – without shutoff valves

OSY – UL/FM outside stem & yoke resilient seated gate valves

CFM – cubic feet per minute meter

GPM – gallons per minute meter

***OSY FxG** – flanged inlet gate connection and grooved outlet gate connection

***OSY GxF** – grooved inlet gate connection and flanged outlet gate connection

***OSY GxG** – grooved inlet gate connection and grooved outlet gate connection

Available with grooved NRS gate valves - consult factory*

Post indicator plate and operating nut available – consult factory*

* Consult factory for dimensions

For additional information, request literature ES-994RPDA

For information on Air Gaps, Vent Elbows and Test Cocks, see page 58 or request literature ES-AG/EL/TC.

For WattsBox Enclosures, request literature ES-WB.

Features

- Stainless steel construction provides long term corrosion resistance and maximum strength
- Stainless steel body is half the weight of competitive designs reducing installation and shipping costs
- Short end-to-end dimensions makes retrofit easy
- Bottom mounted relief valve reduces clearance requirements when installed against an outside wall
- Patented torsion spring check valves provide maximum flow at low pressure drop
- Thermoplastic and stainless steel check valves for trouble-free operation
- No special tools required for servicing
- Compact construction allows for smaller enclosures
- Stainless steel relief valve features a balanced rolling diaphragm to eliminate sliding seals and lower maintenance costs
- Detects underground leaks and unauthorized water use
- GPM or CFM meter available

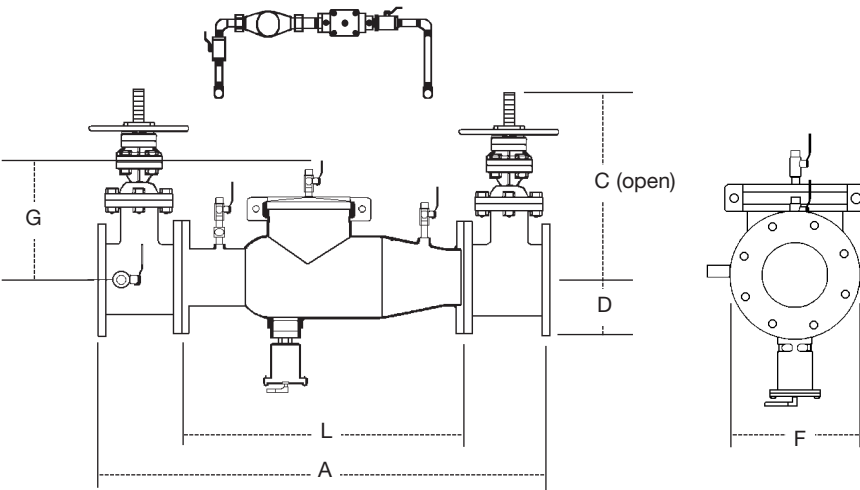

994RPDA

SIZE (DN)		DIMENSIONS (APPROX.)										WEIGHT					
in.	mm	A		C (open)		D		F		G		L		w/Gates		w/o Gates	
		in.	mm	in.	mm	in.	mm	in.	mm	in.	mm	in.	mm	lbs.	kgs.	lbs.	kgs.
2½	65	37	940	16¾	416	10½	267	7	178	10	254	22	559	148	67	60	27
3	80	38	965	18¾	479	10½	267	7½	191	10	254	22	559	226	103	62	28
4	100	40	1016	22¾	578	10½	267	9	229	10	254	22	559	235	107	65	30
6	150	48½	1232	30¾	765	11½	292	11	279	15	381	27½	699	380	172	110	50

Series 909RPDA (2½" – 10")

Reduced Pressure Detector Assemblies

- Designed to prevent the reverse flow of polluted water from entering the potable water system
- For health hazard continuous pressure applications
- Provides protection against backsiphonage and backpressure backflow
- Detects system leaks or unauthorized use of water supply

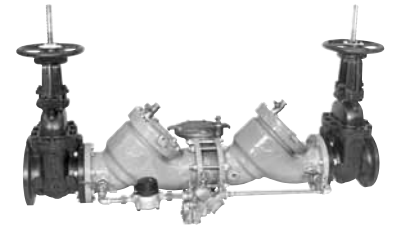

909RPDAOSY

Specifications

- Temperature Range: 33°F – 140°F (0.5°C – 60°C)
- Maximum Working Pressure: 175psi (12.1 bar)

Models

add Suffix:

OSY – UL/FM outside stem & yoke resilient seated gate valves

LF – without shutoff valves (4" – 10") (100 – 250mm)

CFM – cubic feet per minute meter

GPM – gallons per minute meter

For additional information, request literature ES-909RPDA.

For information on Air Gaps, Vent Elbows and Test Cocks, see page 58 or request literature ES-AG/EL/TC.

For WattsBox Enclosures, request literature ES-WB.

Features

- Body construction fused epoxy coated cast iron
- Replaceable bronze seats
- Maximum flow at low pressure drop
- Compact for economy combined with performance
- Design simplicity for easy maintenance
- Furnished with ⅝" x ¾" (16 x 19mm) recordall meter
- Air-in/water-out relief valve design provides maximum capacity during emergency conditions
- No special tools required for servicing

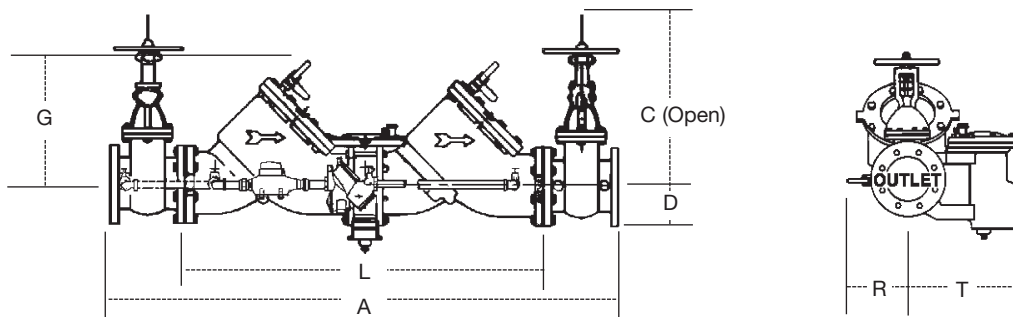

909RPDA

SIZE (DN)		DIMENSIONS (APPROX.)										WEIGHT					
in.	mm	A		C (OSY)		D		G		L		R		T		lbs.	kgs.
		in.	mm	in.	mm	in.	mm	in.	mm	in.	mm	in.	mm	in.	mm		
2½	65	42⅞	1070	16⅜	416	5¼	133	7	178	26⅞	664	14	356	9	229	230	104
3	80	42⅞	1070	18⅞	479	5¼	133	7	178	26⅞	664	14	356	9	229	230	104
4	100	55⅞	1400	22¾	578	6	152	9½	241	37	940	15	381	13⅝	346	470	213
6	150	65½	1664	30⅞	765	6	152	14½	368	44½	1130	16	406	13⅝	346	798	362
8	200	78½	1988	37¾	959	9¾	248	18½	470	55¼	1403	17	432	18½	470	1456	660
10	250	93⅝	2378	45¾	1162	9¾	248	21½	546	67½	1715	18	457	18½	470	2230	1012

Air Gaps and Elbows

for Reduced Pressure Zone Assemblies

Air Gaps for use with backflow preventers on horizontal installations. Can be easily mounted to body

Vent Elbows are used with Watts air gaps for vertical installation of reduced pressure zone backflow preventers

For additional information, request literature ES-AG/EL/TC.



Air Gaps



Elbow

*Epoxy coated

Air Gaps

MODEL	SERIES/SIZES	DIMENSIONS (APPROX.)						WEIGHT	
		A		B		C		lbs.	kgs.
		in.	mm	in.	mm	in.	mm		
909AG-A	1/4" - 1/2" 009, 3/4" 009M2/M3 1/2" - 1" 995	2 3/8	60	3 1/8	79	1/2	13	.63	.28
909AG-C	3/4" - 1" 009/909 1 - 1 1/2" 009M2, 1 1/4" - 2" 995	3 1/4	83	4 7/8	124	1	25	1.50	.68
909AG-F	1 1/4" - 3" 009/909 1 1/4" - 2" 009M1, 2" 009M2	4 3/8	111	6 3/4	171	2	51	3.25	1.47
909AG-K	4" - 6" 909 8" - 10" 909M1	6 3/8	162	9 5/8	244	3	76	6.25	2.83
909AG-M	8" - 10" 909	7 3/8	187	11 1/4	286	4	102	15.50	7.03
919AGC	3/4" & 1" 919	2 3/8	60	3 1/8	79	1/2	13	.63	.28
919AGF	1 1/4" - 2" 919	4 3/8	111	8 7/8	214	3	76	4.26	1.93
957AG	2 1/2" - 10" 957	7 1/2	190	10 3/16	258	2	51	1.5	.68
957AG (Splash Guard)	2 1/2" - 10" 957	-	-	-	-	-	-	-	-
994AGK-P	2 1/2" - 10" 994	8	203	11 1/4	286	2	51	1.50	0.68
995AG	3" - 6" 995	5	127	8	203	2 3/8	60	-	-

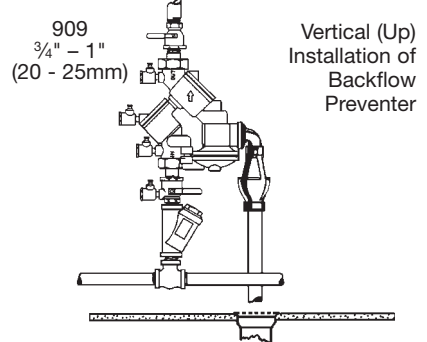
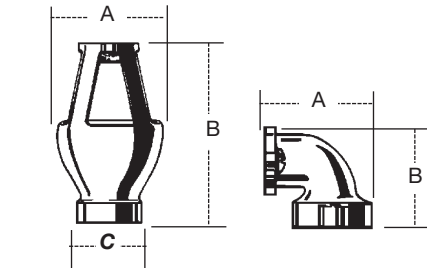

Vent Elbows — Use with Watts Air Gaps for vertical installation of reduced pressure zone assemblies.

909EL-A	1/4" - 1/2" 009, 3/4" 009M2/M3, 1/2" - 1" 995	-	-	-	-	-	-	-	-
* 909EL-C	3/4" - 1" 009/909, 1" - 1 1/2" 009M2, 1 1/4" - 2" 995	2 3/8	60	2 3/8	60	-	-	.38	.17
* 909EL-F	1 1/4" - 2" 009M1, 1 1/4" - 2" 009/909 2" 009M2	3 5/8	92	3 5/8	92	-	-	2	.91
* 909EL-H	2 1/2" - 3" 009/909	-	-	-	-	2	51	-	-
994EL-F (vertical)	2 1/2" - 10" 994	4 7/8	124	9	229	2	51	4	1.8

Test Cocks

For Use With Backflow Preventers, Isolation Valve for Gauges, Isolation Valves for Small Equipment Lines

TC

- Full port ball valve design
- Screwdriver slot to open and close
- Available 1/8" M x 1/4" F or 1/4" M x 1/4" F



SAE-TC Adapter

- 1/4" female SAE x 7/16" FPT
- Adapts to SAE-TC for use with pressure gauge and/or site tube



SAE-TC Brass Cap

for protection of 1/8" SAE-TC (not shown) (four required per backflow preventer)

SAE-TC

- Full port ball valve design
- Screwdriver slot operation
- 1/8" M x SAE



SilverEagle TC

- 1/2" TC for 2 1/2" - 4" series 757 and 957
- 3/4" TC for 6" - 10" series 757 and 957



No. 3 TC with O-Ring

- for 2 1/2" - 4" series 757 and 957
- for 6" - 10" series 757 and 957

Caps & Tethers (Plastic, Brass)

Plastic cap and tether (four required per backflow preventer)

- Fits 1/4" female test cocks
- Plastic dust cap and rubber tether
- RK-TC 1/8"

SAE Brass cap, O-ring and tether

- Fits 1/8" M x SAE test cocks
- Brass dust cap with O-ring seal and rubber tether
- RK-SAE-TC



Plastic Cap and Tether



Brass Cap and Tether

Series 9 (1/4" – 3/8")

Dual Check Vacuum Breakers

- Used to prevent the flow of contaminated water into the potable water supply
- Use where water spillage will not cause damage

Models

N9C – Dual check backflow preventer with atmospheric vent. For continuous pressure applications. Sizes 1/4" (8mm) and 3/8" (10mm) NPT female inlet and outlet connections. Max. pressure 125psi (8.6 bar).

N9 – the same as N9C except in brass finish.

NLF9 – Has a 3/8" (10mm) NPT male inlet connection. Max. pressure 150psi (10.3 bar). For non-continuous pressure applications.

N9-CD – In-line field testable, dual check backflow preventer with atmospheric vent. Non-removable design. Size 3/4" (20mm) hose thread female inlet x 3/4" (20mm) HT male outlet connection. Max. pressure 150psi (10.3 bar). Max. temperature 180°F (82°C).

9D – Dual check backflow preventer with atmospheric vent for continuous pressure. Sizes 1/2" (15mm) and 3/4" (20mm) NPT female union inlet and outlet connections. Max. pressure 175psi (12.1 bar). Min. pressure required 25psi (172.4 kPa). Max. temperature 250°F (121°C).

9DS – same as Model 9D with solder ends.

9BD – Special backflow preventer for vending machine water supply lines. Complies with FDA food additive regulations. Standard size: 3/8" (10mm) flare copper tube (FCT) inlet and outlet. Max. pressure 150psi (10.3 bar). Max. temperature 140°F (60°C).

For additional information, request literature ES-9, ES-N9-CD, or ES-9D-M3,M2.



9D



N9-CD

Series 912HP (3/4", 1")

High Pressure Hose Drop Backflow Preventer

- For isolation protection on high pressure plumbing supply lines, such as high pressure hose drops which are used for the washdown of equipment and facilities
- Ideally suited for food processing plants
- Provides and backpressure backflow protection to prevent the reverse flow of potentially contaminated water from the processing and rendering areas into the potable water supply
- Maximum Working Pressure: 400psi (27.6 bar)
- Maximum Temperature: 160°F (71°C)

Specifications

For non-health hazard applications where continuous pressure conditions exist. Incorporates the use of a bronze ball valve shutoff on the inlet of the assembly and a dual check with atmospheric vent specifically designed to handle the temperature and pressure conditions commonly found in the meat processing industry.

For dimensional and additional information, request literature ES-912HP.



912HP
Patent# 6,397,878B1

Features

- Female national pipe thread inlet and male national pipe thread outlet connections
- Ball valve design includes reinforced/enhanced PTFE seats and electroless nickel plated brass ball
- Blow-out proof pressure retaining stem
- Low profile oval handle
- In the event of fouling of the downstream check valve, leakage would be vented to atmosphere thereby providing a visual indication of failure of the check assembly
- Can be installed vertically (flow up or flow down) or horizontally
- Integral stainless steel screen protects the check assembly from fouling due to dirt and debris

Series 008PCQT (3/8" - 1")

Spill Resistant, Anti-siphon Vacuum Breakers

- Health hazard backflow preventer for continuous pressure applications.
- Designed for indoor point of use applications.
- Prevents backsiphonage of contaminated water into the potable water supply.
- Install 6" above the flood rim if field applied. Install 1" when factory installed or deck/machine mounted.
- Standardly furnished with internal polymer coating.

Specifications

- Sizes 3/8" - 1" (10 - 25mm). NPT female connections
- Temperature Range: 33°F - 180°F (0.5°C - 83°C)
- Maximum Working Pressure: 150psi (10.3 bar)

For additional information, request literature ES-008PCQT.

MODEL	SIZE (DN)		DIMENSIONS (APPROX.)								WEIGHT	
	in.	mm	A		B		C		D		lbs.	kgs.
008PCQT	3/8	10	4 1/8	107	5 1/2	140	1 9/16	40	3 15/16	100	1.6	.7
008PCQT	1/2	15	4 3/8	111	5 1/2	140	1 9/16	40	4 3/16	106	1.7	.5
008PCQT	3/4	20	4 5/16	125	7	178	2 3/8	60	4 5/8	117	3.8	1.7
008PCQT	1	25	5	127	7 1/2	191	2 3/8	60	5 1/8	130	4.8	2.2

Note: A strainer is recommended to be installed ahead of the backflow preventer to prevent the fouling of the check assembly and resultant spillage from the valve during re-pressurization. Do not install in concealed locations or areas where water leakage due to normal wear of the internal parts can cause damage.



008PCQT

Models

add Suffix:

SC - satin chrome finish - with stem. wrench flats in place of Tee handles (contact factory)

S - bronze strainer

L - left sided test cock

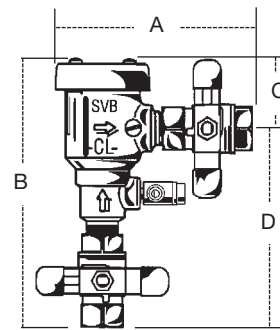

Series 800M4QT, 800M4FR (1/2" - 2")

Pressure Vacuum Breakers

- With tee handle quarter-turn shutoffs on sizes 1/2" - 1" (15 - 25mm)
- Lever handles 1 1/4" - 2" (32 - 50mm)
- For health hazard cross-connections subject to continuous pressure
- Install 12" (305mm) above highest downstream point of water
- Designed to prevent backsiphonage of contaminated water into the potable water supply
- Sizes 1/2" - 2" (15 - 50mm). NPT female connections

Specifications

- Temperature Range: 33°F - 140°F (0.5°C - 60°C)
- Maximum Working Pressure: 150psi (10.3 bar)

For additional information, request literature ES-800M4QT or ES-800M4FR.

For WattsBox Enclosures, request literature ES-WB.



800M4QT

Models

800M4FR - Model 800M4QT with relief valve for freeze protection. Patent #5551473. Sizes 1/2" - 2" (15 - 50mm)

800MQT - compact model with self-contained ball valve shutoffs. Sizes 1/2" and 3/4" (15 and 20mm)

MODEL	SIZE (DN)		DIMENSIONS (APPROX.)								WEIGHT	
	in.	mm	A		B		C		D		lbs.	kgs.
800M4QT/800M4FR	1/2	15	5	127	6 1/4	159	2 9/16	65	3 11/16	94	3.5	1.6
800M4QT/800M4FR	3/4	20	5 3/8	137	6 1/2	165	2 9/16	65	3 15/16	100	3.5	1.6
800M4QT/800M4FR	1	25	5 1/2	139	7 1/2	191	2 3/4	70	4 3/4	121	6.0	2.7
800M4QT/800M4FR	1 1/4	32	8 5/8	219	9	229	3 1/4	83	5 3/4	146	11.0	4.9
800M4QT/800M4FR	1 1/2	40	9	229	9 1/2	241	3 3/4	83	6 1/4	159	13.5	6.1
800M4QT/800M4FR	2	50	9 1/2	241	9 5/8	245	3 3/4	83	6 3/8	162	18.5	8.4
800MQT	1/2	15	4 7/8	124	5 3/8	137	2 1/2	64	2 7/8	73	3.0	1.4
800MQT	3/4	20	4 7/8	124	5 3/8	137	2 1/2	64	2 7/8	73	3.0	1.4

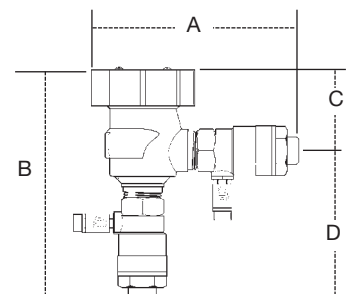

Series 188A, 288A, 289, N388 (1/4" – 3")

Anti-Siphon Vacuum Breakers

- Vacuum breakers are designed to protect against the backsiphonage of contaminated water into the potable water supply.
- For health hazard cross-connections not subject to continuous pressure.
- Install 6" (150mm) above highest downstream point of water.

Specifications

- NPT female inlet and outlet connections, Models 188A/288A.
- Maximum temperature 180°F (82°C) at 125psi (8.6 bar) working pressure.

For additional information, request literature ES-188A, ES-288A, ES-289 or ES-N388.



289

Models

188A – Sizes: 3/4" – 2" (20 – 50mm) irrigation vacuum breaker. Plain brass finish.

288A – Sizes: 1/4" – 3" (8 – 80mm), plain brass finish.

288AC – Sizes: 1/4" – 1" (8 – 25mm), polished chrome finish.

289 – Sizes: 3/8" – 1" (10 – 25mm) spill-resistant atmospheric vacuum breakers. NPT male connections.

N388 – Sizes: 1/4" and 3/8" (8 – 10mm) with NPT female bottom inlet and outlet connections. Bronze body.

Series 7 (3/8" – 1")

Dual Check Valves

- For use at the drinking water supply service entrance or with individual outlets
- Designed for non-health hazard residential water system containment and continuous pressure applications
- Bronze body construction.
- Uses two compact replaceable check modules.
- Buna-N seals and stainless steel springs
- Installed immediately downstream of the residential water meter

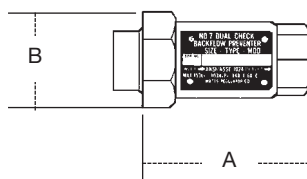

7

Features

- Can be installed vertically or horizontally
- Available with an extensive combination of inlet/outlet sizes, types of thread and end connections including retrofit compression fittings and hose connections
- Can be installed in a variety of piping configurations, and in conjunction with a wide range of meter horns, copper setters and meter boxes
- Testable dual check model available, Series L7U2-2

For additional information, request literature PG-7.

Specifications

- Temperature Range: 33°F – 140°F (0.5°C – 60°C) continuous; 180°F (82°C) intermittent
- Minimum Working Pressure: 10psi (69 kPa)
- Maximum Working Pressure: 150psi (10.3 bar)

MODEL	SIZE (DN)	DIMENSIONS				WEIGHT	
		A		B		lbs.	kgs.
		in.	mm	in.	mm		
7C	3/8 10	2 1/8	73	1 1/4	32	1.6	0.7
7U2-2	1/2 15	4 3/8	111	2 3/8	60	1.75	0.8
7U2-2	3/4 20	4 3/8	111	2 3/8	60	1.75	0.8
7U2-2	1 25	4 3/8	111	2 3/8	60	1.75	0.8

Series Cu7 (1/2" – 1")

Copper-Body Dual Check Valves

- Straight line, poppet-type construction minimizing pressure drop

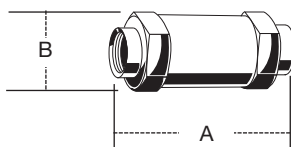

Cu7

Features

- Can be installed vertically or horizontally
- Lead free copper body
- Modular check valves for easy maintenance
- Chloramine resistant materials of construction
- Double unions for installation ease
- Replaceable seats
- Center stem guides for reliable seating

Specifications

- Temperature Range: 33°F – 180°F (0.5°C to 82°C) continuous
- Minimum Working Pressure: 10psi (69 kPa)
- Maximum Working Pressure: 150psi (10.3 bar)

SIZE (DN)	DIMENSIONS				WEIGHT		
	A		B		lbs.	kgs.	
in.	mm	in.	mm	in.	mm		
1/2	15	4 7/16	113	2 3/8	60	1.7	0.8
3/4	20	4 7/16	113	2 3/8	60	1.7	0.8
1	25	4 11/16	119	2 3/8	60	2.0	0.9

For additional information, request literature, PG-7.

For assistance, contact your local authorized Watts agent or visit our website at www.watts.com

Series 8 (3/8" – 3/4")

Hose Connection Vacuum Breakers

- Health hazard, backsiphonage protection, non-continuous pressure
- Designed for attaching to sill cocks and other hose connections

Specifications

- Sizes 3/4" (20mm) hose thread (HT) female inlet x 3/4" (20mm) HT male outlet connection
- Maximum Pressure: 125psi (8.6 bar). Maximum Temperature: 180°F (82°C)

Models

- 8*** – Brass body, removable, non-draining
- 8A*** – Patented “non-removable” feature, drainable. Interlocking spring prevents removal once installed
- 8B*** – Brass body, with breakaway set screw to prevent removal, drainable
- 8C, 8BC and 8AC** – same as above in chrome finish
- NF8C** – Specifically designed for wall and yard hydrants, permits manual draining for freezing conditions. Chrome finish
- NF8** – same as above with brass finish
- 8P** – Thermoplastic body with patented “non-removable” feature and equipped to allow sill cock to be drained
- S8C** – Designed for tub and shower hand spray sets. Chrome finish
- S8** – same as above with plain brass finish
- 8FR** – Freeze relief feature. Protects the valve from freeze damage (Patent Pending)

*Note: Model 8, 8A, and 8B are not suitable for frost-free hydrants.
See Model NF8. For additional information, request literature ES-8.



8B



8FR

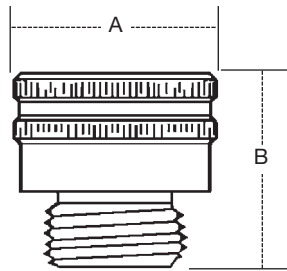

MODEL	SIZE (DN)		DIMENSIONS (APPROX.)				WEIGHT	
	in.	mm	A		B		oz.	gm.
8	3/4 HT	20	1 3/8	35	1 1/2	38	4.0	113.4
8A	3/4 HT	20	1 1/2	38	1 3/4	38	4.0	113.4
8AC	3/4 HT	20	1 1/2	38	1 1/2	38	4.0	113.4
8B	3/4 HT	20	1 1/2	38	1 3/8	35	4.0	113.4
8BC	3/4 HT	20	1 3/8	35	1 1/2	38	4.0	113.4
8C	3/4 HT	20	1 3/8	35	1 1/2	38	4.0	113.4
NF8	3/4 HT	20	1 1/2	38	2	50	5.3	151.2
NF8C	3/4 HT	20	1 1/2	38	2	50	5.3	151.2
8P	3/4 HT	20	1 3/4	44	1 3/8	35	2.0	56.7
S8	1/2 F**	15	1 1/4	32	1 1/2	38	1.5	42.5
S8C	1/2 F**	15	1 1/4	32	1 1/2	38	4.0	113.4
S8C	3/8 F**	10	1 1/4	32	1 1/2	38	4.0	113.4
8FR	3/4 HT	20	1 3/4	44	1 1/2	38	4.0	113.4

HT = Hose threaded connections, female inlet x male outlet connection;
** Female NPT threaded inlet x male NPT outlet connection.

Series Gov. 80M1 (10", 11 1/2", 12 1/2")

Ball Cock and Thermal Expansion Relief Valve

- Triple purpose product: toilet tank ball cock fill valve, anti-siphon backflow preventer and thermal expansion pressure relief valve.

Specifications

- Maximum operating temperature 110°F (43.3°C)
- Standard heights 10", 11 1/2" or 12 1/2" (250, 292, or 318mm)

For additional information, request literature S-Gov80.
For more products to protect against thermal expansion, see pages 33-34.



Gov. 80-M1

Standards

Listed by IAPMO and CSA certified for anti-siphon ball cocks, FDA approved under CFR-21-177-2600, ANSI/ASSE No. 1002.

Series SD2 (1/4" – 3/8")

Dual Check Valve

- Recommended for use on Post-Mix Carbonated Beverage Equipment and dispensing equipment for tea and coffee
- Prevents the reverse flow of potentially contaminated water into the potable water supply due to backpressure backflow
- Designed for protection of the water supply from carbonated water
- For continuous or intermittent pressure conditions



SD2

Models

- SD2-MN** – 1/4" (8mm) Male NPT
- SD2-MN** – 3/8" (10mm) Male NPT
- SD2-FN** – 1/4" (8mm) Female NP
- SD2-FN** – 3/8" (10mm) Female NPT
- SD2-MF** – 1/4" (8mm) SAE Male Flare
- SD2-MF** – 3/8" (10mm) SAE Male Flare
- SD2-FF** – 1/4" (8mm) SAE Female Flare
- SD2-FF** – 3/8" (10mm) SAE Female Flare

For additional information, request literature ES-SD2.

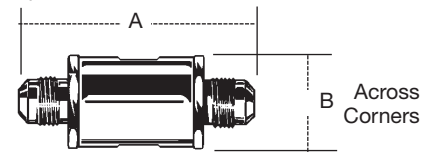

MODEL	SIZE (DN)		DIMENSIONS (APPROX.)			
	in.	mm	A		B	
			in.	mm	in.	mm
SD2-MN	1/4	8	3	76	1 1/16	27
SD2-MF	1/4	8	2 3/16	71	1 1/16	27
SD2-MN	3/8	10	3	76	1 1/16	27
SD2-MF	3/8	10	3	76	1 1/16	27
SD2-FN	1/4	8	3	76	1 1/16	27
SD2-FF	1/4	8	2 3/16	71	1 1/16	27
SD2-FN	3/8	10	3	76	1 1/16	27
SD2-FF	3/8	10	3	76	1 1/16	27

Series SD3 (1/4" – 3/8")

Dual Check Valve with Atmospheric Port

- Recommended for use on Post-Mix Carbonated Beverage Equipment and dispensing equipment for tea and coffee
- Prevents the reverse flow of potentially contaminated water into the potable water supply due to backpressure backflow
- Designed for protection of the water supply from carbon dioxide and carbonated water
- For continuous or intermittent pressure conditions
- Wye strainer for water supply installations

Models

- SD3-MN** – 1/4" (8mm) Male NPT
- SD3-MN** – 3/8" (10mm) Male NPT
- SD3-MF** – 1/4" (8mm) Female NPT



SD3

- SD3-MF** – 3/8" (10mm) Female NPT
- SD3-MF** – 1/4" (8mm) SAE Male Flare
- SD3-MF** – 3/8" (10mm) SAE Male Flare

For additional information, request literature ES-SD3.

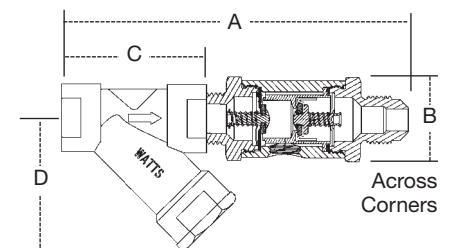

MODEL	SIZE (DN)		DIMENSIONS (APPROX.)							
	in.	mm	A		B		C		D	
			in.	mm	in.	mm	in.	mm	in.	mm
SD3-MN	1/4	8	4 1/2	114	1 1/16	27	1 7/8	48	1 11/16	43
SD3-MF	1/4	8	4 3/8	111	1 1/16	27	1 7/8	48	1 11/16	43
SD3-MN	3/8	10	4 1/2	114	1 1/16	27	1 7/8	48	1 11/16	43
SD3-MF	3/8	10	4 1/2	114	1 1/16	27	1 7/8	48	1 11/16	43
SD3-FN	1/4	8	4 1/2	114	1 1/16	27	1 7/8	48	1 11/16	43
SD3-FN	3/8	10	4 1/2	114	1 1/16	27	1 7/8	48	1 11/16	43

Series TWS (3/4", 1")

Key Operated Wall Hydrants for Irrigation System Winterization

- For use on irrigation sprinkler systems
- Provides access to the home's water supply from the outside
- Water supply shutoff is key operated
- For use with pressure vacuum breaker (PVB), atmospheric vacuum breaker (AVB), double check (DC) or reduced pressure zone (RPZ) backflow preventers
- Non-freeze wall hydrant

Specifications

- Sizes 3/4", 1" (20, 25mm), NPT male outlet connection
- 8", 10", 12" (200, 250, 300mm) shaft lengths
- Temperature Range: 33°F – 140°F (0.5°C – 60°C) continuous; 180°F (82°C) intermittent



TWS

- Maximum Working Pressure: 175psi (12.1 bar)

For additional information, request literature ES-TWS.

Model TK-7

- Water column sight tube for testing dual check and double check valves
- Tests individual check modules of the Watts Model 7, 709 and 007

Wgt. 5 lbs. (2.3 kg)



TK-7

For additional information, request literature ES-TK-7.

Model TK-9A

- +/- 2% accuracy full scale
- Test kit easily connects to any testable backflow preventer assembly
- Designed for testing all testable backflow preventers

Maximum Pressure: 175psi (12.1 bar)

Maximum Temperature: 210°F (98.9°C)

Wgt. 8 lbs. (3.6 kg)



TK-9A

For additional information request literature ES-TK-9A.

Model TK-99D

- Features 0.25% full scale accuracy
- Compact, hand held, digital backflow preventer test kit
- LCD display with oversized differential characters and separate supply pressure readout gauge, high impact casing
- Tests RPZ's, Double checks or PVB's

Wgt. 3 lbs. (1.4 kgs.)



TK-99D

For additional information, request literature ES-TK-99D.

Model TK-99E

- +/- 1% accuracy full scale
- Compact test kit with color coded valves, hoses and top mounted bleed valves
- Designed for testing all testable backflow preventers

Wgt. 8 lbs. (3.6 kg)



TK-99E

For additional information, request literature ES-TK-99E.

Model TK-DL

with Digital Print-Out and Computer Download Capability.

- +/- 0.2% accuracy full scale
- An advanced piece of test equipment designed to make pressure and differential gauges obsolete in the testing of backflow preventers
- Accuracy, portability, versatility and documentation
- Contains hoses, adapters, digital print-out unit and a rugged case

Wgt. 15 lbs. (6.8 kg).



TK-DL

For additional information, request literature ES-TK-DL.

Series SS07F (4" – 10")

Stainless Steel Single Detector Checks

- For automatic fire sprinkler systems
- With optional by-pass assembly, detects leakage or misuse of water in fire line
- By-pass assembly kits with GPM/CFM meter. Size 3/4" (20mm)

Specifications

- Temperature Range: 33°F – 110°F (0.5°C – 43°C)
- Rated Working Pressure: 175psi (12.1 bar).
- 125# flanged connections



SS07F

For additional information, request literature ES-SS07F.

Series TR (4" – 10")

Transition Riser

- Durable and easy to install underground transition fitting to connect the municipal water supply into the building overhead fire system

Features

- Reduces installation time and labor costs associated with field assembly
- Corrosion resistant stainless steel construction type 304SST

- Ease of installation and lightweight allows one person to position and handle the riser
- Minimal site preparation; joint restraint one-piece construction reduces time and labor; no missing parts, no leaks; easily identifiable for approvals
- UL/FM approved
- Available in 4" – 10" (102 – 254mm) with various lengths to meet all local requirements



TR

- Designed to meet NFPA 24 Section 8-3.2
- AWWA C900 Inlet
- AWWA C606 Outlet

For additional information, request literature ES-TR.

Series FR 500 (1/8" – 3/4")

Thermostatic Freeze Relief Kits

- Designed to keep water from freezing in the backflow preventer
- Compact
- Easy to install
- Low maintenance
- Controlled by water temperature vs. air temperature
- IAPMO approved

Specifications

- Working Temperature: 35°F (1.6°C)
- Maximum Pressure: 175psi (12.1 bar)



FR 500

For additional information, request literature ES-FR500.

Series RK-W-STD

- Valve and meter support stands for quick & easy installation
- All-welded steel construction
- Corrosion resistant coating
- Interior drain hole
- Available in 10" to 38" heights

For additional information, request literature ES-RK-W-STD.



RK-EZ-STD

Series WVS

Valve Setters for Quick Backflow Installation

- Available Sizes: 3", 4", 6", 8" and 10" (80, 100, 150, 200 and 250mm)
- Compact
- Corrosion resistant epoxy coating
- Eliminates thrust blocks at the backflow
- Fits 757N/757NDCDA, 957N, 957NRPDA



WVS MJ x FL

For additional information, request literature PF-WVS.

Series WB WattsBox

Backflow Preventer Freeze Protection Enclosures

- Especially made for PVB, Double check and RPZ backflow preventer assemblies that are subjected to freezing conditions
- Construction is reinforced aluminum or fiberglass. Designed to meet NFPA guidelines.
- Easy access for testing/certification of backflow preventer
- Removable for maintenance purposes
- Available with or without thermostatically controlled heat source to provide protection to -30°F (-34°C). RPZ, protected against intrusion of foreign matter
- WattsBox enclosures are lockable and can be anchored



WB

Specifications

- Flip top access, fiberglass construction enclosures for ¾" – 3" (20 – 80mm) pipe size backflow preventers and ¾" – 2" (20 – 50mm) PBV's
- Front access panel, aluminum construction enclosures for 2½" – 10" (65 – 250mm) backflow preventers

For additional information, request literature ES-WB.

Series WattsRock

Options

WattsRock shell – WPLRN

WattsRock shell with insulation – WPLR

WattsRock shell with insulation and heat – WPHR

Features

- Durable polyethylene shell
- Drain sizing for full port discharge
- Vandal protection
- Lifelike shape and coloring
- Testing/maintenance access
- Available in two natural stone shades — slate grey and earthtone brown



WattsRock

For additional information, request literature ES-WattsRock.

Series W-SPL and W-FLG

Make-Up Spools and Flanges

- For backflow preventers 2½" – 10" (65 – 250mm)
- Make-up spools for use when retrofitting a backflow preventers into an installation where an existing backflow preventer is being replaced
- Make-up flanges for use in piping applications where there is a need for additional fitting lay length



For additional information, request literature ES-Spools/Flanges.

Series B6000 (1/4" – 4")

B6001 (3/8" – 3")

2-Piece, Standard Port, Bronze Ball Valves

- Two-piece ball valves
- For commercial and industrial applications
- Suitable for a full range of liquids and gases

Specifications

- Pressure Rating: 1/4" – 3" (8 – 80mm) – 600psi (41.3 bar) WOG (non-shock) – 150psi (10.3 bar) WSP
4" (100mm) – 400psi (27.5 bar) WOG (non-shock) – 125psi (8.6 bar) saturated steam, over 150psi (10.3 bar) requiring SS trim
- Temperature Range: 0°F to 450°F (-18°C – 232°C) at 50psi (3.4 bar) for reinforced/enhanced PTFE seats. 0°F – 350°F (-18°C – 177°C) at 50psi (3.4 bar) for Virgin PTFE seats.

Models

B6000 – Sizes 1/4" – 4" (8 – 100mm), NPT female connections

B6001 – Sizes 3/8" – 3" (10 – 80mm), solder connections

B6000 – UL: UL approved for:

- Flammable liquids (YR BX)
- Compressed gas (YQ NZ)
- Fire protection (HNFX), sizes 1/4" – 2" (8 – 50mm)
- LP Gas (YS DT), sizes 1/4" – 3" (8 – 80mm)
- Natural/Manufactured gas (YR PV), sizes 1/4" – 3" (8 – 80mm)
- For #1 and #2 Fuel Oil (MHKZ), sizes 1/4" – 3" (8 – 80mm)

Standards

Meets Federal Specification WW-V-35C, and complies with MSS-SP-110.



B6001

Features

- Sizes: 1/4" – 3" (8 – 80mm) have reinforced/enhanced PTFE seats
- 4" (100mm) has virgin PTFE seats
- Chrome plated brass ball
- Adjustable stem packing gland
- Blow out proof, pressure retaining stem

For additional information, request literature ES-B6000.

For ball valve options, refer to page 75.

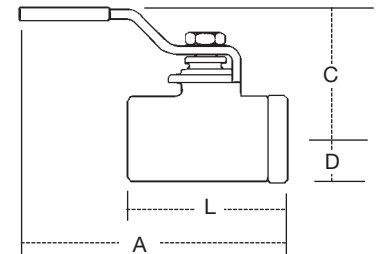

MODEL	SIZE (DN)		BALL		DIMENSIONS (APPROX.)								WEIGHT	
	in.	mm	Orifice in.	Orifice mm	A		C		D		L		lbs.	kgs.
B6000	1/4	8	3/8	9.5	5	127	1 3/4	45	5/8	16	2 1/16	52	0.6	0.3
B6000	3/8	10	3/8	9.5	5	127	1 3/4	45	5/8	16	2 1/16	52	0.6	0.3
B6000	1/2	15	1/2	13.0	5	127	1 3/4	45	5/8	16	2 1/4	58	0.6	0.3
B6000	3/4	20	1 1/16	17.0	5 5/16	135	2	51	3/4	19	2 13/16	72	1.0	0.5
B6000	1	25	7/8	22.0	5 1/2	140	2 1/4	57	7/8	22	3 7/16	87	1.6	0.7
B6000	1 1/4	32	1	25.0	7	178	2 1/2	64	1 1/8	29	3 3/8	99	2.2	1.0
B6000	1 1/2	40	1 1/4	32.0	7	178	3	76	1 5/16	33	4 1/4	108	3.2	1.5
B6000	2	50	1 1/2	38.0	11	279	3 5/16	84	1 1/2	38	4 13/16	122	4.9	2.2
B6000	2 1/2	65	2	51.0	11 15/16	294	4	102	2 3/16	56	6 1/2	165	13.2	5.9
B6000	3	80	2 1/2	64.0	11 3/8	295	4 1/4	108	2 3/8	60	6 13/16	173	17.5	7.9
B6000	4	100	3	76.0	15 5/8	384	4 13/16	122	2 15/16	75	7 11/16	195	29.3	13.3
B6001	3/8	10	3/8	9.5	5 1/16	129	1 1/2	38	5/8	16	2 5/16	50	0.5	0.2
B6001	1/2	15	1/2	13.0	5 3/16	132	1 3/4	44	5/8	16	2 3/8	60	0.6	0.3
B6001	3/4	20	1 1/16	17.0	5 3/4	146	2	51	3/4	19	3 5/16	84	1.1	0.5
B6001	1	25	7/8	22.0	6	150	2 1/4	57	7/8	22	3 3/4	95	1.4	0.6
B6001	1 1/4	32	1	25.0	8	203	2 3/4	64	1 1/8	29	4 1/2	114	2.0	0.9
B6001	1 1/2	40	1 1/4	32.0	8 1/8	206	3	76	1 5/16	33	5	127	3.3	1.5
B6001	2	50	1 1/2	38.0	11 7/16	290	3 5/16	84	1 1/2	38	6 1/4	159	5.2	2.4
B6001	2 1/2	65	2	51.0	12 1/8	307	4	102	2 3/16	56	7 5/8	194	13.2	6.0
B6001	3	80	2 1/2	64.0	12 5/16	312	4 1/4	108	2 3/8	60	8 3/16	208	15.6	7.1

Series B6080, B6081 (1/2" – 2")

2-Piece, Full Port, Bronze Ball Valves

- Two-piece construction
- For commercial and industrial applications
- PTFE seats and seals

Specifications

- Pressure Rating: 600psi (41.3 bar) WOG (non-shock) and 150psi (10.3 bar) WSP
- Temperature Range: 0°F – 350°F (-18°C – 177°C) at 50psi (3.4 bar)
- Complies with MSS-SP-110

Models

B6080 – Sizes: 1/2" – 2" (15 – 50mm), NPT female connections

B6081 – Sizes: 1/2" – 2" (15 – 50mm), solder connections

For ball valve options, refer to page 75.

For additional information, request literature ES-B6080.



B6080

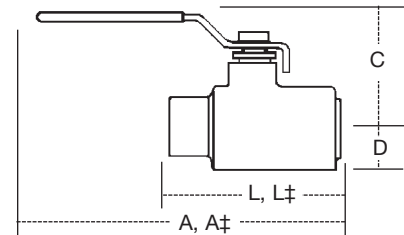

SIZE (DN)		BALL ORIFICE		DIMENSIONS (APPROX.)												WEIGHT	
				THREADED		SOLDER		C		D		L		SOLDER			
in.	mm	in.	mm	A		A†		C		D		L		L†		lbs.	kgs.
1/2	15	1/2	13	4 ²⁵ / ₃₂	121	4 ⁷ / ₈	124	1 ⁵ / ₈	41	7/ ₈	22	2 ⁹ / ₃₂	58	2 ⁹ / ₁₆	65	0.6	0.3
3/4	20	3/4	19	5	127	5 ⁵ / ₁₆	135	1 ³ / ₄	45	1	25	2 ¹³ / ₁₆	71	2 ¹³ / ₁₆	71	1.0	0.5
1	25	1	25	5 ⁷ / ₁₆	138	5 ¹¹ / ₁₆	145	2	50	1 ¹ / ₄	32	3 ⁹ / ₁₆	91	3 ⁷ / ₈	98	1.8	0.8
1 ¹ / ₄	32	1 ¹ / ₄	32	7 ⁹ / ₁₆	192	7 ⁹ / ₁₆	192	2 ⁷ / ₈	73	1 ¹ / ₂	38	4 ¹ / ₈	105	4 ⁹ / ₁₆	110	4.0	1.8
1 ¹ / ₂	40	1 ¹ / ₂	38	7 ¹¹ / ₁₆	195	7 ⁷ / ₈	200	3	76	1 ⁵ / ₈	41	4 ⁷ / ₁₆	113	4 ³ / ₄	121	5.5	2.5
2	50	2	50	10 ¹¹ / ₁₆	272	11	279	4	102	2	50	5 ³ / ₈	137	6	152	10.0	4.5

Series EMVII-6400SS (1/4" – 3")

2-Piece, Standard Port, Bronze Electric Motor Valves

- Combination quarter-turn shutoff ball valve and electric actuator
- Compact and completely assembled

Specifications

- Steam Working Pressure: 100psi (7bar)
- Sizes: 1/4" – 2" (8 – 50mm) are 600psi (41.3 bar) WOG (non-shock); sizes 2 1/2" – 3" (65 – 80mm), 400psi (27.6 bar) WOG (nonshock)
- Maximum Operating Temperature: 250°F (121°C)
- 24VAC and 115VAC models
- Maximum Ambient Room Temperature: 150°F (66°C)

For additional information, request literature ES-EMVII-6400SS.



EMVII-6400SS

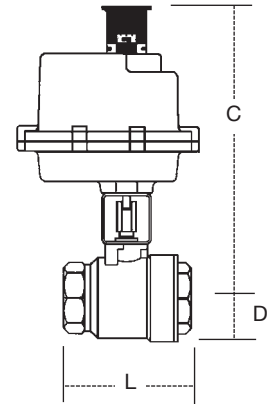

MODEL	SIZE (DN)		DIMENSIONS (APPROX.)						WEIGHT	
	in.	mm	C		D		L		lbs.	kgs.
† EMVII-6400SS-115-8	1/4	8	7 13/16	198	5/8	16	2 1/4	57	8.75	3.9
† EMVII-6400SS-115-8	3/8	10	7 13/16	198	5/8	16	2 1/4	57	8.75	3.9
† EMVII-6400SS-115-8	1/2	15	7 13/16	198	5/8	16	2 1/4	57	8.75	3.9
† EMVII-6400SS-115-35	3/4	20	8	203	3/4	19	2 7/8	76	9.25	4.2
† EMVII-6400SS-24-40	1	25	8 13/16	208	1	25	3 7/16	87	10.25	4.6
† EMVII-6400SS-115-35	1 1/4	32	8 15/16	227	1 1/8	29	3 15/16	100	10.75	4.9
† EMVII-6400SS--24-40	1 1/2	40	9 1/8	232	1 3/8	35	4 5/16	110	11.75	5.3
† EMVII-6400SS-24-40	2	50	12 1/8	308	1 5/8	41	4 7/8	124	14.25	6.5
†† EMVII-6400SS-115-25	2 1/2	65	14 3/16	360	–	–	6 1/2	165	23.00	10.4
†† EMVII-6400SS-115-25	3	80	14 1/2	368	–	–	6 13/16	173	27.50	12.5

† Sizes 1/4" – 2" (8 – 50mm) are available 115-8, 115-35 and 24-40. †† Sizes 2 1/2" & 3" (65 and 80mm) also available 24-25.

Series B6300, B6301 (1/2" – 1")

2-Piece, Full Port, Ball and Waste Bronze Ball Valves

- For draining or venting of downstream line when valve is in the closed position



B6301

Specifications

- Pressure Rating: 400psi (27.6 bar) WOG (non-shock)
Temperature Range: 0°F – 350°F (-18°C – 177°C) at 50psi (3.4 bar)

Models

B6300 – Sizes 1/2" – 1" (15 – 25mm), NPT threaded connections.

B6301 – Sizes 1/2" – 1" (15 – 25mm), solder connections.

For additional information, request literature ES-B6300.

5

Ball Valves

Series B6780 (1/4" – 2"), B6781 (1/2" – 1")

2-Piece, Full Port, Bronze Diverter Ball Valves

- Two-piece construction
- Three-way diverter valve
- For residential, commercial and industrial applications



B6780

Specifications

- Pressure Rating: 400psi (27.6 bar) WOG (non-shock) and 125psi (8.6 bar) saturated steam
- Temperature Range: 32°F – 350°F (0°C – 177°C) at 50psi (3.4 bar)

Models

B6780-M1 – Sizes 1/4" – 2" (8 – 50mm), NPT female connections

B6781 – Sizes 1/2" – 1" (15 – 25mm), solder connections

For additional information, request literature ES-B6780.

Series B6002 (1/4" – 1")

2-Piece, Standard Port, Bronze Ball Valves

- Male NPT connection x NPT female connection

Specifications

- Sizes: 1/4" – 1" (8 – 25mm), have male NPT connection x female NPT connection
- Pressure Rating: 600psi (41.3 bar) WOG (non-shock), 150psi (10.3 bar) saturated steam
- Temperature Range: -20°F – 450°F (-29°C – 232°C) at 50psi (3.4 bar)
- Chrome plated brass ball
- Blow-out proof stem
- High cycle life reinforced PTFE stem packing seal and thrust washer

For additional information, request literature ES-B6002.



B6002

Series B6010, B6011, B6013 (1/2" – 2")

2-Piece, Standard Port, Bronze Ball Valves

- Maintenance of ball valve can be done without dismantling pipe line
- Two-piece construction

Specifications

- Sizes 1/2" – 2" (15 – 50mm)
- Pressure Rating: 400psi (27.6 bar) WOG (non-shock) threaded and solder ends; not steam rated due to union gasket
- Temperature Range: 0°F – 225°F (-18°C – 107°C) at 200psi (13.8 bar)

Models

B6010 – union NPT female connection x NPT female connection, 1/2" – 2" (15-50mm)

B6011 – Solder union connection x solder connection, 1/2" – 2" (15 – 50mm)

B6013 – Solder connection x NPT male connections, 1/2" – 1" (15 – 25mm)



B6010

For additional information, request literature ES-B6010.

Series B6400 (1/4" – 4")

2-Piece, Standard Port, Bronze Ball Valves with Mounting Pad

- Two-piece construction
- Bronze body
- Chrome plated brass ball
- For commercial and industrial applications

Specifications

- Sizes 1/4" – 4" (8 – 100mm), NPT female connections
- Pressure Rating: 1/4" – 2" (8 – 50mm) 600psi (41.3 bar) WOG (non-shock); 150psi (10.3 bar) WSP
2 1/2" – 4" (65 – 100mm) 400psi (27.6 bar) WOG (non-shock); 125psi (8.6 bar) WSP
- Temperature Range: -55°F – 425°F (-48° – 218°C) at 50psi (3.4 bar)



B6400

For ball valve options, refer to page 75.

For additional information, request literature ES-B6400.

Series B6400-SE (1/4" – 2")

2-Piece, Standard Port, Bronze Ball Valves with Safety Exhaust

- Two-piece construction
- Bronze body
- Chrome plated brass ball
- For industrial air applications
- Ideal for use where protection of machine tools is critical
- Unidirectional valve vents downstream air when in closed position

Specifications

- Sizes: 1/4" – 2" (8 – 50mm), NPT female connections.
- Pressure Rating: 175 CWP (12.1 bar).
- Temperature Range: 50°F – 120°F (10°C – 49°C).



B6400-SE

For additional information, request literature ES-B6400-SE.

Series B6800 (1/4" – 2")

B6801 (1/2" – 2")

3-Piece, Full Port, Brass Ball Valves

- Three-piece, in-line maintenance design
- For commercial and industrial applications

Specifications

- Pressure Ratings: 1/4" – 1" (8 – 25mm) 600psi (41.3 bar) WOG (non-shock); 1 1/4" – 2" (32 – 50mm) rated at 400psi (27.6 bar) WOG (non-shock); 150psi (10.3 bar) WSP all sizes. Over 150psi (10.3 bar) WSP requires SS trim
- Temperature Range: 0°F – 450°F (-18°C – 232°C) at 50psi (3.4 bar)

Models

B6800 – Sizes: 1/4" – 2" (8 – 50mm) NPT female connections

B6801 – Sizes: 1/2" – 2" (15 – 50mm) solder connections

B6800SE (safety exhaust) – for downstream exhaust 1/4" – 2" (8 – 50mm), Virgin PTFE seats and seals, rated at 145psi (10.0 bar) WOG, maximum 50°F – 120°F (10°C – 49°C)

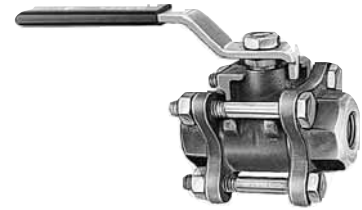

B6800

For additional information, request literature ES-B6800.

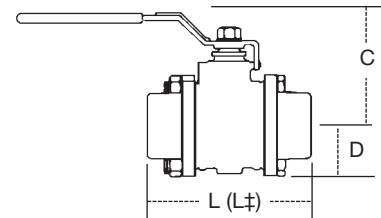

MODEL	SIZE (DN)		BALL ORIFICE		DIMENSIONS (APPROX.)						WEIGHT	
	in.	mm	in.	mm	C		D		L (L±)		lbs.	kgs.
B6800, –	1/4	8	3/8	10	1 3/4	44	7/8	22	2 3/8	60	1.1	0.5
B6800, –	3/8	10	3/8	10	1 3/4	44	7/8	22	2 3/8	60	1.1	0.5
B6800, B6801‡	1/2	15	1/2	13	1 3/4	44	7/8	22	2 3/8	60	1.1	0.5
B6800, B6801‡	3/4	20	3/4	19	2 1/4	57	1 7/8	48	3 1/4	83	2.5	1.1
B6800, B6801‡	1	25	1	25	2 3/4	70	1 3/8	35	3 7/8	98	4.1	1.9
B6800, B6801‡	1 1/4	32	1 1/4	32	3	76	1 1/2	38	4 1/2	114	6.3	2.9
B6800, B6801‡	1 1/2	40	1 1/2	38	3 1/2	89	1 3/4	44	5	127	9.3	4.2
B6800, B6801‡	2	50	2	50	3 7/8	98	2	50	6 5/8	168	13.8	6.3

‡= Solder connections

Series B6000-CC (1/2" – 3/4")

B6001-CC (1/2" – 3/4")

2-Piece, Standard Port, Bronze Ball Valves

Models

- **B6000-CC** has female NPT x 3/4" hose end with end cap and chain
- **B6001-CC** has solder end x 3/4" hose end with end cap and chain

Specifications

- Pressure Rating: 200psi (13.8 bar) CWP (non-shock)

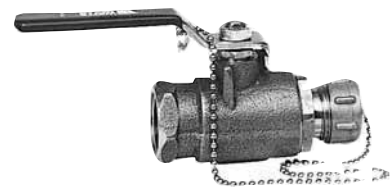

B6000-CC

For additional information, request literature ES-B6000.

Ball Valve Options and Repair Kits

SUFFIX	DESCRIPTION	MODELS	SIZES	KIT DESCRIPTION	
AD	Assembled Dry	All	<i>in.</i> All	<i>mm</i> All	*
BS	Balance Stop Plate	B6000/B6001 B6080/B6081 B6800/B6801 B6400	¼ – 3 ¼ – 2 ¾ – 2 ¼ – 3	8 – 80 8 – 50 20 – 50 8 – 80	BHK
G	Grounded Ball & Stem	All SS Models	¼ – 3	8 – 80	*
GS	Grounded Stem	All	All	All	*
SC	Satin Chrome	B6000/B6001	All	All	*
SE	Safety Exhaust	B6400/B6800/B6801	All	All	*
SS	Stainless Steel Ball & Stem	All	All	All	BSK-SS
UL	UL Approved	B6000/B6001 B6800/B6801	¼ – 2	8 – 50	*
VT (01)	Virgin Teflon® Seat & Seal PTFE	All	All	All	SSK-01
Z15	Without Lever & Nut	B6000/B6001 B6800/B6801	All	All	*
04	Mineral Filled PTFE	B6000/B6001 B6800/B6801/B6400	All	All	*
HANDLE OPTIONS					
LC	Latch Lock Lever Handle Closed Position (without lock)	B6800/B6800SE B6400SE	¼ – 2	8 – 50	LL-HK (specify closed position)
LH	Locking Lever Handle (without lock)	B6000/B6001 B6400/B6400SE B6800/B6801	½ – 2 ¼ – 4 ½ – 2	15 – 50 8 – 100 15 – 50	LH-HK
LL	Latch Lock Lever Handle	B6000/B6001 B6400/B6400SE B6800/B6801	½ – 2 ¼ – 4 ½ – 2	15 – 50 8 – 100 15 – 50	LL-HK (without lock)
OV	Oval Handle	All	All	All	OH-HK
RH	Round Handle	All	¼ – 2	8 – 50	RH-HK
SH	Stainless Steel Lever Handle & Nut	All	¼ – 2	8 – 50	SH-HK0
TH	Tee Handle	All	All	All	TH-HK
XH	Extended Lever Handle	All	¼ – 2	8 – 50	XHK-LH

* **NOTE:** Ball valve option only, no kit available
For additional information, request literature PL-RP-GP.



Locking Handle



Oval Handle



Round Handle



Tee Handle



Extended Handle

Series IT6300, IS6301 (½" – 1")

2-Piece, Full Port, Ball and Waste Brass Ball Valves

- Drain cock allows draining of downstream line when valve is in closed position

Specifications

- Pressure Rating: 600psi (41.3 bar) WOG (non-shock)

Models

IT6300 – Sizes ½" – 1" (15 – 25mm), NPT threaded connections

IS6301 – Sizes ½" – 1" (15 – 25mm), solder connections



IT6300

For additional information, request literature ES-IT6300.

Series FBV (1/2" – 2")

2-Piece, Full Port, Bronze Ball Valves

- Excellent for throttling and balancing applications
- For non-abrasive liquids or gases
- Two-piece construction

Specifications

- PTFE seats.
- Pressure Rating: 1/2" – 2" (15 – 50mm), 600psi (41.3 bar) WOG (non-shock), and 125psi (8.6 bar) WSP
2 1/2" & 3" (non-shock) (65 – 80mm) 400psi (27.6 bar) WOG and 125psi (8.6 bar) saturated steam
- Temperature Range: 0°F – 350°F (-18°C – 177°C) at 50psi (3.4 bar)



FBV

Series FBV-3C, FBVS-3C (1/4" – 3")

2-Piece, Full Port, Brass Ball Valves

- Suitable for a full range liquids and gases
- Complies with MSS-SP-110
- Certified to NSF/ANSI Standard 61 
- CSA approved (1/2" – 2" threaded only), UL/FM approved (1/2" – 2" threaded only), UL Listed (1/2" – 2" solder)

Specifications

- Temperature Range: -40°F to 400°F (-40°C to 204°C)
- Pressure Ratings:
 - FBV-3C: 1/4" – 2" (8 – 50mm)**
 - 600psi (41.3 bar) WOG, non-shock
 - 150psi (10.3 bar) WSP
 - 2 1/2" – 3" (65 – 80mm)**
 - 600psi (41.3 bar) WOG, non-shock
 - 125psi (8.6 bar) WSP
 - FBVS-3C: 1/2" – 2" (15 – 50mm)**
 - 600psi (41.3 bar) WOG, non-shock
 - 150psi (10.3 bar) WSP
 - 2 1/2" – 3" (65 – 80mm)**
 - 400psi (27.5 bar) WOG, non-shock
 - 125psi (8.6 bar) WSP
 - FBV-3C-SS/FBVS-3C-SS: 1/2" – 2" (15 – 50mm)**
 - 600psi (41.3 bar) WOG, non-shock
 - 150psi (10.3 bar) WSP



FBV-3C

Models

FBV-3C – 1/4" – 3" (8 – 80mm) threaded end connections

FBVS-3C – 1/2" – 3" (15 – 80mm) solder end connections

FBV-3C-SS – 1/2" – 2" (15 – 50mm) threaded end connections

FBVS-3C-SS – 1/2" – 2" (15 – 50mm) solder end connections

Handle Options

Available with 2" stem extension, memory stop, and tee handles.

For additional information, request literature ES-FBV-3C.

Series FBV-3C-QC (1/2" – 1")

2-Piece, Full Port, Brass Ball Valves with Quick-Connect Technology

- Watts integral Quick-Connect inlet and outlet connections
- Can be used with Copper, CPVC, PEX and PB pipe
- Approved to ASSE 1061
- Can be rotated under pressure
- Can be removed and reused without the use of tools

Specifications

- Temperature Range: -40°F to 180°F (-40°C to 82°C)
- Pressure Ratings: 200psi @180°F (13.8 bar @ 82°C)



FBV-3C-QC

FBVS-3C-QC – 1/2" – 3" (15 – 80mm) Quick-Connect end connections

For additional information, request literature ES-FBV-3C-QC.

Series FBV-3-Press (1/2" – 4")

2-Piece, Full Port, Brass Ball Valves with Integral Press Fitting End Connection

- Designed for use in ProPress® Piping Systems



FBV-3-Press

Specifications

- Dezincification-resistant brass body
- NSF/ANSI 61 Certified 1/2" – 2" (15 – 100mm)
- UL Listed
- Designed for types K, L, and M hard copper tubing 1/2" - 4" (15 - 100mm) and soft copper tubing 1/2" – 1 1/4" (15 - 32mm)
- Press end connections comply to ASTM-B88
- Press connection rated to 200psi CWP up to 210°F (13.4 bar to 99°C)
- Adjustable packing gland
- Bottom loaded, blowout proof stem with stem O-ring seal
- Press Fitting rated to 200psi CWP up to 212°F (13.4 bar to 98°C)

For additional information, request literature ES-FBV-3-Press.

5

Ball Valves

Series FBV-4, FBVS-4 (1/4" – 3")

2-Piece, Full Port, Brass Ball Valves

- Suitable for a full range of liquids or gases
- Complies with MSS-SP-110



FBV-4

Specifications

Temperature Range: -40°F to 400°F (-40°C to 204°C)

Pressure Rating: 1/4" – 2"

600psi (41.3 bar) WOG non-shock

2 1/2" – 3"

400psi (27.6 bar) WOG non-shock

Models

FBV-4 1/4" – 3" (8 – 80mm) threaded end connections

FBVS-4 1/2" – 3" (15 – 80mm) solder end connections

For additional information, request literature ES-FBV-4.

Series FBV-PEX (1/2" – 1")

2-Piece, Full Port, Brass Ball Valves with PEX Ends

- Series FBV-PEX 2-Piece, Full Port, Brass Ball Valve with PEX Ends are designed for use in PEX piping systems



FBV-PEX

Specifications

- Ball Valve Rating: 400 WOG
- Crimp Connection Rating: 160psi at 73°F (23°C) (refer to PEX piping manufacturers guidelines)
- 2-pieces, full port design
- UNS C37700 Forged brass body
- PEX end designed to ASTM-F-1807
- Valve rated to 400 WOG
- Crimp connection rated to 160psi at 73°F (23°C)
- Designed specifically for use in PEX piping systems

For additional information, request literature ES-FBV-PEX.

Series WBV-3, WBVS-3 (1/8" – 4")

2-Piece, Standard Port, Brass Ball Valves

- Suitable for full range of liquids and gases
- Virgin PTFE stem packing seal
- Adjustable stem packing gland
- Vinyl insulator on heavy duty Zinc plated carbon steel handles
- 1/4-turn open or close operation
- Low operating torque

Specifications

- Pressure Rating: 400psi (27.6 bar) WOG (non-shock)

Models

WBV-3 – Sizes 1/8" – 4" (3 – 100mm), NPT threaded connections

WBVS-3 – Sizes 3/8" – 3" (10 – 80mm), solder connections



WBVS-3

Handle Options

Available with 2" stem extension, memory stop, oval and tee handles.

For additional information, request literature ES-WBV-3.

Series WBVC (1/2" – 1")

2-Piece, Standard Port, Brass Ball Valves

- For a full range of gases and liquids on commercial, residential and industrial applications

Models

WBVC – Sizes 1/2" – 1" (15 – 25mm), male NPT compression connections



WBVC

For additional information, request literature ES-WBVC.

Series S-FBV-1, C-FBV-1 (1/4" – 3")

2-Piece, Full Port, Carbon and Stainless Steel Ball Valves

- Two-piece, full port, investment cast ball valves
- For commercial and industrial applications

Specifications

- Pressure Rating: 1000psi (69.0) WOG (non-shock), 125psi (8.6 bar) WSP

Standards

Conforms to Federal Specification WW-V-35C, Type II, Composition BZ, Style 3

Models

C-FBV-1 – Sizes: 1/4" – 3" (8 – 80mm) carbon steel, NPT female connections

S-FBV-1 – Sizes: 1/4" – 3" (8 – 80mm) stainless steel, NPT female connections



C-FBV-1



S-FBV-1

For additional information, request literature ES-S-FBV-1 or ES-C-FBV-1

Series G4000M1 (2" – 6") Series G4000M (8" – 10")

2-Piece, Full Port, Cast Iron Flanged Ball Valves

- Fast quarter-turn operation
- 304 Stainless steel ball and stem
- Same end-to-end dimensions (ANSI B16.10) and flange dimensions (ANSI B16.1) as an ANSI Class 125 cast iron, flanged gate valve



G4000M1

Models

G4000M1 Predator™ Series – Sizes 2" – 6" (50 – 150mm), flanged ball valves with 125psi (8.6 bar) steam rating. 200psi (13.8 bar) CWP (non-shock) at 140°F (60°C).

G4000-FDA – Sizes: 2" – 6" (50 – 150mm) interior and exterior fused epoxy coating, FDA approved, with lever handle. 200psi (13.8 bar) CWP (non-shock) at 140°F (60°C).

G4000M – Sizes 8", 10" (200, 250mm), with manual gear operator. 200psi (13.8 bar) CWP (non-shock) at 140°F (60°C).

G4000M-FDA – Sizes 8" – 10" (200 – 250mm), FDA approved fused epoxy coating, with manual gear operator. 200psi (13.8 bar) CWP (non-shock) at 140°F (60°C).

For additional information, request literature ES-G4000, ES-G4000-FDA or ES-G4000M1.

Series GBV (3/8" – 1")

2-Piece, Brass Gas Ball Valves

- Brass two-piece body construction
- Available with tee handle or square handle

Models

GBV – Sizes 3/8" – 1" (10 – 25mm), NPT female connections and tee handle.

GBV-FL – Sizes 1/2" x 3/8", 1/2" x 1/2", 3/4" x 5/8" (15 x 10, 15 x 15, 20 x 24mm), Female NPT x Flare connections and tee handle.

GBV and GBV-FL – rated 32°F to 125°F (0°C – 52°C). CSA approved @ 1/2, 2 and 5psi (3.4, 13.8, 34.5 kPa). UL listed @ 5psi (34.4 kPa).

For additional information, request literature ES-GBV.



GBV



GBV-FL

Series GBV-1 (1/2" – 3/4")

1-Piece, Brass Gas Ball Valves

- Sizes 1/2" and 3/4" (15 – 20mm) NPT female connections
- New Blowout Proof Stem Design

Features

- Patented Blowout Proof Stem Design
- One-piece Body
- UL approved @ 5psi (34.4 kPa)
- Approved by CSA @ 1/2, 2 and 5psi (3.4, 13.8, 34.5 kPa). UL listed @ 5psi (34.4 kPa)
- Capacity: 1/2" @ 295 ft.3/hr., 3/4" @ 760 ft.3/hr
- Tested under Standards Z21.15 IAS Requirement

For additional information, request literature ES-GBV-1.



GBV-1

Series 6 (1/4" – 1")

Brass Midi Check Valves

- Install in a horizontal or vertical position
- Positive back stop
- Silent operation

Specifications

- Maximum Working Pressure: 200psi (13.8 bar)
- Maximum Temperature: 180°F (82°C)

Models

Series 6 – Sizes 1/4" – 1" (8 – 25mm), NPT threaded female connections



6

For additional information, request literature ES-ICVF-125.

Series 600, 601S (1/4" – 2")

Bronze Silent Check Valves

Models

600

- Teflon® seat and brass disc
- Install in a horizontal or vertical position
- Stainless steel guide rod and spring
- Silent check operation
- Prevents water hammer

Sizes 1/4" – 2" (8 – 50mm), NPT threaded female connections; 15psi (1 bar) WSP @ 250°F (121°C), and 400psi (27.6 bar) WOG non-shock @ -20°F to 100°F (-29° to 38°C)

601, 601S

- Similar to Model 600 but especially designed for well pump service and other applications requiring tight seating
- Bronze seat with Viton® disc

Sizes 1/4"-1/2" (8 – 15mm) threaded connections, 1/2" – 1" (15 – 25mm), solder connections; 400psi (27.6 bar) WOG. @100°F (38°C)

600-Z3 – Sizes 3/4", 1 1/2" (20, 40mm), NPT female connection; 400psi (27.6 bar) WOG non-shock @-20°F to 100°F; 150psi (10.3 bar) WSP @ 360°F. Heavy duty construction; stainless steel disc, spring and guide rod



600

For additional information, request literature ES-600, ES-601 or ES-600-Z3.

Series ICV-125-2-2-T (2" – 12")

Cast Iron Wafer Check Valves

Specifications

- Designed for HVAC and general service applications
- A Buna-N seat, bonded to the valve body, provides leak tight sealing from -40°F – +250°F (-40°C – 121°C)
- Designed and tested according to API 594 for use between ANSI Class 125 or 150 flanges
- Lightweight, compact design, easy installation
- PTFE bearings and 316 stainless steel springs
- Standard ASTM A216 cast iron body with aluminum-bronze disc plates
- 2"-12" (50-300mm); 200psi (13.8 bar) CWP @ 150°F (66°C),
- Silent check valve eliminates water hammer effect



ICV-125-2-2-T

For additional information, request literature ES-ICV-125-2-2-T.

Series ICVW-125 (2" – 10")

Cast Iron, Silent Check Valves

Specifications

- Designed for HVAC and general applications
- Can be installed either horizontally or vertically to provide shutoff to 200psi @ 150°F (13.8 @ 66°C). Consult factory for proper installation in vertical position
- For use between ANSI Class 125 and Class 250 flanges
- ASTM A-126 Class B cast iron body with B-62 bronze globe style disc and seat
- 316SS conical spring
- Silent check valve operation eliminates water hammer effect



ICVW-125

For additional information,
request literature ES-ICVW-125.

Series ICVF-125 (2" – 6")

Flanged Cast Iron Silent Check Valves

Specifications

- Designed for HVAC and general applications
- Can be installed either horizontally or vertically to provide shutoff to 200psi @ 150°F. Consult factory for proper installation in vertical position
- For use between ANSI Class 125 and Class 250 flanges
- ASTM A-126 Class B cast iron body with B-62 bronze globe style disc and seat
- 316SS conical spring
- Silent check valve operation eliminates water hammer effect



ICVF-125

For additional information,
request literature ES-ICVF-125.

Series 408-OSY-RW (2½" – 12")

OSY Flanged Gate Valves

- ASTM A-126 Class B cast iron shutoff valves
- UL Listed, FM approved
- ANSI B16.1 flanged connections
- Complies with MSS-SP-70
- For distribution service and fire main shutoff

Specifications

- Pressure Rating: 175psi (12.1 bar) CWP
- Maximum Temperature: 140°F (60°C)
- Epoxy coated
- Resilient wedge (Buna-N)

Models

408-OSY-RW – Sizes 2½" – 12" (65 – 300mm), flanged connections.



408-OSY-RW

For additional information, request literature ES-408-OSY-RW.

Series 403RT-RW (2" – 6")

Ring-tite Gate Valve

- Irrigation and water shutoff distribution service
- Resilient wedge gate

Specifications

- Pressure Rating: 200psi (13.8 bar) CWP
- Maximum Temperature: 140°F (60°C)

Models

403RT-RW – Sizes 2" – 6" (50 – 150mm), ring tite connections
ASTM A126 Class B cast iron. Epoxy coated internally and externally



403RT-RW

For additional information, request literature ES-403RT-RW.

Series 405, 406 (2" – 12")

NRS Flanged Gate Valves

- ASTM A-126 Class B cast iron shutoff valves for water service

Specifications

- Pressure Rating: 200psi (13.8 bar) CWP
- Epoxy coated
- Maximum Temperature: 140°F (60°C)
- ANSI B16.1 flanged connections

Models

405RW – Sizes 2" – 12" (50 – 300mm), flanged connections. Non-rising stem, resilient wedge design. For irrigation and water distribution service.

406-NRS-RW – Sizes 2" – 12" (50 – 300mm), flanged connections. AWWA C509 specifications. Resilient wedge design. Non-rising stem. For potable water, water distribution service, sewage disposal facilities.

406E – Sizes 2½" – 12" (65 – 300mm), (no 8" available) flanged connections. MSS-SP70. IBBM style, non-rising stem.



406E

For additional information, request literature ES-405RW, ES-406-NRS-RW or ES-406E.

Series 411 (2" – 10")

Class 125, Iron Swing Check Valves

- For water service on fire protection systems
- UL/FM Listed, 2½" – 10"

Specifications

- Pressure Rating: 175psi (13.8 bar) CWP
- Maximum Temperature: 180°F (82°C)
- ASTM A-126 Class B cast iron body
- Complies with MSS-SP-71

Models

411 – Sizes 2" – 10" (50 – 250mm), cast iron body and disc, with Buna-N disc seat, ANSI B16.1 flange connections, epoxy painted external surfaces



411

For additional information, request literature ES-411.

Series GV, GVS, GLV (¼" – 4")

Bronze Shutoff Valves

- For general service on water, steam, oil or compressed gas

Specifications

- Pressure Rating: 125psi (8.6 bar) WSP/200psi (13.8 bar) WOG
- Maximum Temperature: 353°F (178°C)

Models

GV gate valves – Sizes ¼" – 4" (8 – 100mm), NPT female threaded connections, non-rising stem

GVS gate valves – Sizes ¾" – 3" (10 – 80mm), solder connections, non-rising stem.

GLV globe valves – Sizes ¼" – 2" (8 – 50mm), NPT female threaded connections, swivel type disc.



GV

For additional information, request literature ES-GV, ES-GVS or ES-GLV.

Series WGV (½" – 4")

Brass Gate Valves

- For shutoff service
- Non-rising stem (NRS)

Specifications

- Pressure Rating: 200psi (13.8 bar) WOG
- Maximum Temperature: 180°F (82°C)

Models

- **WGV (round handle)** – Sizes ½" – 4" (15 – 100mm), NPT female threaded connections
- **WGVS (round handle)** – Sizes ½" – 2" (15 – 50mm), solder connections
- **WGV-X (cross handle)** – Sizes ½" – 3" (15 – 80mm), NPT female threaded connections



WGV

For additional information, request literature ES-WGV.

Series WGVS-1, WGVC (1/2" – 2 1/2")

Brass Gate Valves

- For general shutoff applications
- Non-rising stem (NRS)

Specifications

WGVS-1

- Pressure Rating: 200psi (13.8 bar) WOG
- Maximum Temperature: 180°F (82°C)

WGVC

- Pressure Rating: 125psi (8.6 bar) WOG
- Maximum Temperature: 140°F (60°C)

Models

WGVS-1 – Sizes 1/2" – 2 1/2"
(15 – 65mm), solder connections

WGVC – Sizes 1/2", 3/4"
(15 – 20mm), compression ends



WGVC

For additional information, request literature ES-WGV, ES-WGVS or ES-WGVC.

6

Gate / Globe / Check Valves

Series WCV (1/2" – 4")

Brass Swing Check Valves

- For one-way flow of water and steam applications

Models

WCV – Sizes 1/2" – 4" (15 – 100mm), NPT threaded female connections. Pressure rating 125psi (8.6 bar) WSP/200psi (13.8 bar) WOG.

WCVS – Sizes 1/2" – 2" (15 – 50mm), solder connections. Pressure rating 125psi (8.6 bar) WSP/200psi (13.8 bar) WOG.

WCV-2 – Sizes 1/2" – 2" (15 – 50mm), NPT threaded female connections. Rubber seat material is NBR. Pressure rating 200psi (13.8 bar) WOG. Maximum temperature 140°F (60°C).



WCV

For additional information, request literature ES-WCV.

Series CV, CVY (3/8" – 4")

Bronze Swing Check Valves

- For one way flow on water, steam, gas or oil lines
- Used to prevent reverse fluid flow



CVY

Specifications

- Pressure Rating: 125psi (8.6 bar) WSP and 200psi (13.8 bar) WOG

Models

CV – 90° straight pattern – Sizes: 3/8" – 4" (10 – 100mm), NPT threaded female connections

CVS – 90° straight pattern – Sizes: 1/2" – 3" (15 – 80mm), solder end connections

CVY – Wye pattern – Sizes: 3/8" – 2" (10 – 50mm), NPT female connections

CVYS – Wye pattern – Sizes: 1/2" – 2" (15 – 50mm), solder end connections

For additional information, request literature ES-CV, ES-CVY, ES-CVS or ES-CVYS.

Series 77S-M1 (1/4" – 3")

Cast Iron Wye-pattern Strainers

- For liquid or steam service
- Install strainers up stream of equipment that need protection from scale, rust, dirt, etc

Specifications

Pressure Rating: (non-shock) 250psi WSP (17.2 bar) @ 406°F (208°C), 400psi WOG (27.6 bar) @ 150°F (66°C)

For additional information, request literature F-C77.

Models

77S-M1 – Sizes: 1/4" – 3" (8 – 80mm), NPT threaded female inlet/outlet connections. Sizes 1/4" – 2 1/2" (8 – 65mm) have 20 mesh strainer screen; 3" size has 3/64" perforated screen. Working pressures same as 77SI.



77S

77SI – Sizes: 1/4" – 3" (8 – 80mm), NPT threaded female connections. Sizes 1/4" – 2" (8 – 50mm) have 20 mesh strainer screen. Size 2 1/2" (65mm) and 3" (80mm) have 3/64" (1mm) perforated screens.

Series 77F-DI-125, 77F-DI-250, 77F-DI-FDA-125 (2" – 12")

Iron Body, Flanged End, Wye-pattern Strainers

- For liquid and steam service to protect check valves, backflow preventers and similar controls from foreign matter.
- ANSI Class 125 and 250

Models

77F-DI-125 – cast iron body, ANSI Class 125 flanged connections. Pressure rating of (non-shock) 125psi (8.6 bar) WSP @ 353°F (178°C), 200psi (13.8 bar) WOG @ 210°F (99°C) comply with MIL-S 16293 Type II.

77F-DI-250 – ductile iron body, ANSI Class 250 flanged connections. Pressure ratings of (non-shock) 250psi (17.2 bar) WSP @ 406°F (208°C), 500psi WOG (34.4 bar) @ 150°F (66°C).

77F-DI-FDA-125 – Class 125 flanged connections. Double coated, electrostatically applied heat fused epoxy coating on interior/exterior. FDA approved suitable for potable water/food contact. Ideal for liquid service where a non-corrosive construction/clean cosmetic appearance is required. Water pressure 200psi (13.8 bar) @ 140°F (60°C). Not for use on steam or gas.

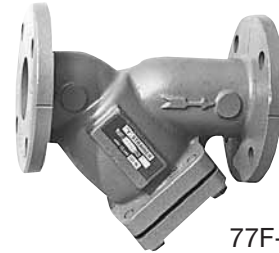

77F-DI-FDA

Note: Self-cleaning can be accomplished by opening a valve or removing the closure plug attached to the blow-off outlet.

Blow-Off Outlet: Tapped NPT female.

End Flanges: The dimensions and drilling of end flanges conform to the American cast iron flange standard, Class 125 and 250 (ANSI B16.1.)

For additional information, request literature ES-77F-DI-125, ES-77F-DI-250 or F-C77.

Series 777 (1/4" – 4")

Bronze Wye-type Strainers

- For liquid or steam service to protect valves or similar controls from foreign matter

Specifications

Maximum Working Pressure: 400psi WOG (27.6 bar); 4" 777 & 777S 300psi (20.7 bar) WOG and 125psi WSP (8.6 bar)

Sizes 1/4" – 2 1/2" (8 – 65mm) have a 20 mesh strainer screen. Size 3" (80mm) has 3/64" (1mm) perforated screen, and 4" (100mm) has 1/8" (3mm) perforated screen

Models

777 – solid retainer cap for strainer screen.

Sizes: 1/4" – 4" (8 – 100mm) NPT female threaded inlet/outlet connections

777S – retainer cap tapped for closure plug (plug not furnished) – Sizes 1/2" – 4" (15-100mm), NPT female threaded connections

S777 – solid retainer cap – Sizes 1/2" – 2" (15 – 50mm), solder end connections

S777S – retainer cap tapped for closure plug (plug not included) - Sizes 1/2" – 2" (15 – 50mm), solder end connections

777SI – wye type, threaded connections, with tapped retainer cap and closure plug. Sizes 3/8" – 3" (10 – 80mm)



777

S777SI – wye type, solder connections, 400 WOG/125WSP with tapped retainer cap and closure plug. Sizes 1/2" – 2" (15 – 50mm)

For additional information, request literature ES-777, ES-777SI or ES-S777.

Series 77F-BI (2" – 8")

Bronze, Flanged, Wye-pattern Strainers

- For liquid or steam service

Specifications

Sizes 2" – 12" (50 – 300mm), bronze ASTM B-62 body, screen cover and plug (furnished), and 304SS screen openings of $\frac{3}{64}$ " (1mm) for 2" – 3" and $\frac{1}{8}$ " (3mm) for 4" – 8". The 77F-BI is U.L. listed. Flanges in accordance with ANSI B16.1, Class 125. Working pressures of 150psi WSP (10.3 bar) @ 406°F (208°C), 225psi WOG (15.5 bar) @ 150°F (66°C).

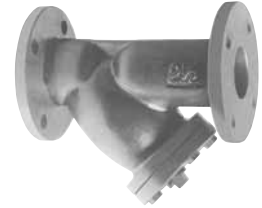

77F-BI

For additional information, request literature ES-77F-BI.

Series 27 ($\frac{1}{8}$ " – $\frac{1}{2}$ ")

Bronze Compact Vee-pattern Water Strainers

- For beverage dispensers, ice cube machines, dental equipment, instrument control systems and similar applications

Models

27 – Sizes $\frac{1}{8}$ " – $\frac{1}{2}$ " (3 – 15mm), NPT female threaded connections. Standard screen is 40 mesh, other mesh types available, consult factory. Maximum pressure 250psi CWP (17.2 bar).



27

For additional information, request literature ES-27.

Model 745 ($\frac{3}{4}$ ")

45° Wye-pattern Bronze Strainers

- For applications where scheduled cleaning of the strainer screen makes a hand removable knurled retainer cap desirable

Models

745 – Size $\frac{3}{4}$ " (20mm), NPT female connections, 80 mesh strainer screen. 250psi CWP (17.2 bar) @ 210°F (99°C), and 50psi WSP (345 kPa) @ 280°F (138°C).

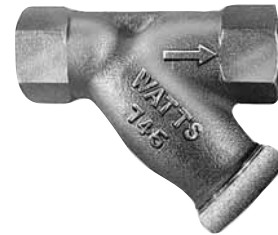

745

For additional information, request literature ES-745.

Series 17 ($\frac{3}{4}$ " – 1")

Bronze In-line Single Union End Strainers

- For quick removal of equipment for cleaning, or where feed line separation is required

Models

17 – Sizes $\frac{3}{4}$ ", 1" (20, 25mm), union end, NPT threaded female connections, #40 mesh strainer screen standard

Specifications

- Pressure Rating: 250psi (17.2 bar) WOG @ 180°F (82°C)



17

For optional screens, consult factory. For additional information, request literature ES-17.

Series 88CSI (1/2" – 2")

Cast Steel, Wye-Pattern Strainers

- For liquid or steam service
- Threaded NPT or socket weld

Specifications

Sizes 1/2" – 2" (15 – 50mm), ASTM A-216 WCB body, ASTM A-105 retainer cap and plug (furnished), non-asbestos cap gasket, and 304SS screens of 1/32" (.8mm) for 1/2"-1 1/2" and 3/64" (1mm) for 2". Working pressures of 600psi WSP (41.3 bar) @ 489°F (254°C), 1480psi WOG (102 bar) @ 100°F (38°C).



88CSI

88CSI-T – Threaded NPT

88CSI-SW – Socket Weld

For additional information, request literature ES-88CSI.

Series 77F-CSI (1/2" – 6")

Cast Steel, Flanged, Wye-pattern Strainers

- For liquid or steam service

Specifications

Sizes 1/2" – 6" (15 – 150mm), ASTM A-216 WCB body and screen cover, ASTM A-105 plug (furnished), PTFE gasket, and 304SS screens of 1/32" (.8mm) for 1/2"-1 1/2", 3/64" (1mm) for 2" – 3" (50 – 80mm) and 1/8" (3mm) for 4" – 6" (100 – 150mm).

Flanges in accordance with ANSI B16.1, Class 150. Working pressures of 150psi WSP (10.3 bar) @ 400°F (204°C), 285psi WOG (19.6 bar) @ 100°F (38°C).



77F-CSI

For additional information, request literature ES-77F-CSI.

Series 87SI (1/2" – 3")

Stainless Steel, Wye-pattern Strainers

- For liquid or steam service
- Threaded NPT or socket weld

Specifications

Sizes 1/2" – 2" (15 – 50mm), ASTM A-351 316SS body and retainer cap, PTFE cap gasket, and 304SS screens of 1/32" (.8mm) for 1/2" – 2" (15 – 50mm) and 3/64" (1mm) for 2 1/2" – 3" (65 – 80mm). Working pressures of 300psi WSP (20.7 bar) @ 400°F (204°C), 720psi WOG (49.6 bar) @ 100°F (38°C).



87SI

For additional information, request literature ES-87SI.

Series P777-100 (1/4", 3/8")

Plastic Body Wye Strainers

- 45° acetal plastic wye strainers for OEM applications requiring an inexpensive corrosion resistant material

Specifications

- Pressure Rating: 300psi CWP
- NSF approved acetal plastic

Models

P777-100 – Sizes 1/4", 3/8" (8, 10mm) has 100 mesh screen, NPT female connections



P777-100

For additional information, request literature ES-P777.

Series 88S (1/4" – 2")

Stainless Steel Wye-pattern Strainers

- For liquid and steam service to protect mechanical equipment from debris
- ANSI Class 600: Liquids 1440psi (99 bar) @ 100°F (38°C), Steam 600psi (41.3 bar) @ 489°F (254°C)

Specifications

Sizes 1/4"- 2" (8-50mm), NPT threaded female connections, perforated strainer screen 1/16" (2mm). All 316SS construction.



88S

For additional information, request literature ES-88S.

Series 77F-CSSI (1/2" – 12")

Stainless Steel, Wye-pattern Strainers

- For liquid or steam service

Specifications

Sizes 1/2"- 12" (15 – 300mm), ASTM A-351 316SS body and screen cover, ASTM A-182 316SS plug (furnished), PTFE gasket, and 304SS screens of 1/32" (.8mm) for 1/2" – 1 1/2", 3/64" (1mm) for 2" – 3" (50 – 80mm), and 1/8" (3mm) for 4" – 12" (100 – 300mm).

Flanges in accordance with ANSI B16.1 Class 150. Working pressures of 150psi WSP (10.3 bar) @ 400°F (204°C), 275psi WOG (18.9 bar) @ 100°F (38°C).



77F-CSSI

For additional information, request literature ES-77F-CSSI.

Series 77F-SS, 77G-SS (2 1/2" – 12")

Stainless Steel Wye-pattern Strainers, Flanged and Grooved

- Light weight, 304SS corrosion resistant alternative to cast iron strainers
- For liquid service
- Complies with NSF 61 and FDA standards
- Blow off outlet tapped NPT female

Specifications

- Sizes 2 1/2" – 12" (65-300mm)
- Pressure Rating: 200psi (13.8 bar) WOG (nonshock) at 150°F (66°C)
- ANSI B16.1 Class 125 flange dimensions and drilling



77G-SS

For additional information, request literature ES-77F/77G.

Series 97FB-CI (2" – 12")

Cast Iron, Simplex Basket Strainers

- For liquid and steam service

Specifications

Sizes 2" – 12" (50 – 300mm), ASTM A-126 Class B cast iron body, screen cover, and plug (furnished). Non-asbestos gasket and 304SS perforated screens of 3/64" (1mm) for 2" – 3" (50 – 80mm), 1/8" (3mm) for 4" – 12" (100 – 300mm).

Flanges in accordance with ANSI B16.1 Class 125.

Models

97FB-CIB – Bolted cover

97FB-CIC – Clamp cover

Working Pressures:

97FB-CIB – 125psi (8.6 bar) WSP/ 200psi (13.8 bar) WOG

97FB-CIC – 50psi (3.4 bar) WOG



For additional information, request literature ES-97FB-CI.

Series 97FB-CSSI (2" – 12")

Cast 316SS Flanged Basket Strainers

- For liquid service only

Specifications

Body, cover, and plug are constructed of ASTM A-351 Grade CF8M cast 316SS. The gasket materials is PTFE. All perforated strainer screens are 304SS.

Models

97FD-CSSIB – Bolted screen retainer cover

Working Pressures:

97FD-CSSIB – 275psi (13.8 bar) WOG



For additional information, request literature F-C77.

Series 97FD-CIB (5" – 14")

Cast Iron, Duplex Basket Strainers

- For liquid service only

Specifications

Sizes 5" – 14" (125 – 350mm), ASTM A-126, Class B cast iron body, screen cover, and plug (furnished). Non-asbestos gasket and 304SS perforated screens of 1/8" (3mm).

Flanges in accordance with ANSI B16.1 Class 125.

Models

97FD-CIB – Bolted cover

Working Pressures:

97FD-CIB – 200psi (13.8 bar) WOG

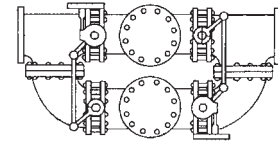

97FD-CIB

For additional information, request literature F-C77.

Series 97FB-FSFE (3" – 10")

UL/FM Fire Service Steel Strainer

- Used in conjunction with a water spray system to protect system against clogging that can be caused by particles fouling the small discharge opening of the sprinkler heads. Designed to trap foreign material 1/8" diameter or larger

Specifications

- Epoxy coated steel strainer, flange x flange, groove x groove or groove x flange with multiple cleanouts
- 304 stainless steel strainer element
- Sizes 3", 4", 6", 8" and 10" (80, 100, 150, 200 and 250mm)
- Maximum Working Pressure: 175psi (12.1 bar)
- Temperature Range: 140°F (60°C)
- Body material Corrosion resistant fusion-bonded epoxy-lined and coated steel
- Flanges AWWA Class "D" Grooves AWWA C606



97FB-FSFE

For additional information, request literature ES-97FB/GB.

For assistance, contact your local authorized Watts agent or visit our website at www.watts.com

Series CSM-61 (1/2" – 3")

Flow Measurement Valves

- Used for hot or chilled water units for system balancing/flow measurement

Models

CSM-61-M1-T – bronze body – Sizes 1/2" – 3" (15 – 80mm), NPT female threaded inlet/outlet

CSM-61-M1-S – bronze body – Sizes 1/2", 3/4", 1", 2 1/2" (15, 20, 25, 65mm), solder connections

CSM-61-M2-S – bronze body – Sizes 1 1/4", 1 1/2" and 2" (32, 40, 50mm), solder connections

Applications

- Fan coil units
- Unit ventilators
- Water source heat pumps
- Finned radiation
- Reheat coils
- Unit heaters
- Small domestic hot water lines



CSM-61-M1

- Convectors
- Small residential boilers/circuits

For additional information, request literature ES-CSM-61.

Series CSM-81 (2 1/2" – 8")

Flow Measurement Valves

- Used for hot or chilled water units for system balancing/flow measurement

Models

CSM-81-F – semi-steel body – Size 2 1/2" – 8" (65 – 200mm), flanged connections.

- Finned radiation
- Reheat coils
- Unit heaters
- Small domestic hot water lines
- Convectors
- Small residential boilers/circuits

Applications

- Fan coil units
- Unit ventilators
- Water source heat pumps



CSM-81-F

For additional information, request literature ES-CSM-81.

Series CSM-91 (2 1/2" – 12")

Large Flow Measurement Valves

- For medium and large flow rate HVAC systems and pump package/cooling towers
- Easy installation and positive shutoff for servicing equipment
- Incorporates a micrometer type handwheel adjustment
- Tamper-proof memory stop

Models

CSM-91* – Sizes 2 1/2" – 12" (65 – 300mm), grooved end connections. Ductile iron body ASTM A536 GR65-45-12. Maximum working pressure 375psi (25.8 bar). Maximum temperature 230°F (110°C).



CSM-91

* **Note:** Series CSM-91 valves are shipped as a straight pattern from the factory. To convert to an angle pattern, refer to IS-Sheet shipped with valve.

For additional information, request literature ES-CSM-91.

Series TDV (2½" – 12")

Combination Balancing, Shutoff, and Check Valve for Single, Double, and Vertical In-line Pump Applications

- Combines functions of a positive hand-tight shutoff valve, check valve and flow control valve into one versatile package



TDV

Models

TDV – Sizes 2½" – 12" (65 – 300mm), grooved end connections. Ductile iron body. Anti-rotation lugs on inlet/outlet of the body

- Grooved ends: Maximum working pressure 375psi (25.8 bar). Maximum temperature 230°F (110°C)

Note: Series TDV valves are shipped as a straight pattern from the factory. To convert to an angle pattern, refer to instruction sheet shipped with valve.

For additional information, request literature ES-TDV.

Series PG

Pressure Differential Gauges for Testing Flow Measurement Valves/Orifices for Watts Series CSM/FMO.

- Used to check differential pressures across system components

Models

PG-2 – 0 – 16 ft. of water (0 – 4,876.8 kgs./m²)

PG-3 – 0 – 35 ft. of water (0-10,668 kgs./m²)

PG-4 – 0 – 100 in. of water (0 – 2,540 kgs./m²)

PG-5 – 0 – 200 in. of water (0 – 5,080 kgs./m²)

PG-6 – 0 – 50 in. of water (0 – 1,270 kgs./m²)

PG-8 – 0 – 135 in. of water (0 – 3,429 kgs./m²)



PG-8

For additional information, request literature ES-PG-2-6, ES-PG-8.

Series GBF-H, GBF-G (2½" – 10")

Grooved End Butterfly Valves

- For positive shutoff service on commercial, irrigation, HVAC and industrial applications
- Ductile iron body
- Grooved end designed to ANSI/AWWA C-606 Rigid Grooved Specification

Specifications

- Maximum Operating Temperature: 275°F (135°F)
- Maximum Operating Pressure: 175psi (12.1 bar) CWP

Models

- GBF-H with lever handle
- GBF-G with gear operator

For additional information, request literature ES-GBF.



GxG Butterfly Valves

SIZE (DN)		DIMENSIONS								WEIGHT			
in.	mm	A in.	A mm	B in.	B mm	C in.	C mm	D in.	D mm	E in.	E mm	lbs.	kgs.
2½	65	3⅞	98	2⅞	73	2⅞	65	4	102	1⅝	41	8.51	3.87
3	80	3⅞	98	3⅞	90	2⅞	75	4⅝	109	1⅝	41	10.08	4.58
4	100	4⅞	116	4½	115	3⅝	92	5	128	1⅝	41	15.93	7.24
6	150	5⅞	149	6⅝	169	5¼	133	5⅝	151	2⅞	54	30.34	13.79
8	200	5¼	134	8⅜	223	6½	166	7⅞	194	2⅞	58	46.18	20.99
10	250	6⅞	160	10⅜	274	8½	216	7⅞	194	2⅞	56	75.22	34.19

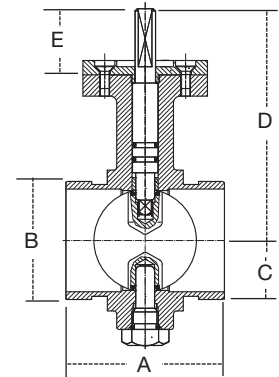

Gear Operator

SIZE (DN)		GEAR RATIO	DIMENSIONS								WEIGHT	
in.	mm		A in.	A mm	D in.	D mm	H in.	H mm	L in.	L mm	lbs.	kgs.
2½	65	24:1	5¾	146	4	102	2½	64	7½	191	11.06	24.38
3	80	24:1	5¾	146	4	102	2½	64	7½	191	11.06	24.38
4	100	24:1	5¾	146	4	102	2½	64	7½	191	11.06	24.38
6	150	24:1	5¾	146	4	102	2½	64	7½	191	11.06	24.38
8	200	30:1	12	305	6	152	3	76	10½	267	23.90	52.69
10	250	30:1	12	305	6	152	3	76	10½	267	23.90	52.69

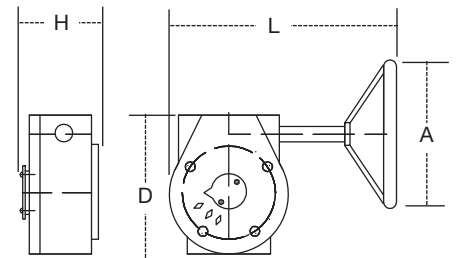

Handle Length

SIZE (DN)		WEIGHT			
in.	mm	F in.	F mm	lbs.	kgs.
2½	65	10⅞	268	1.58	3.48
3	80	10⅞	268	1.58	3.48
4	100	10⅞	268	1.58	3.48
6	150	14⅜	360	1.58	3.48
8	200	15½	394	3.64	8.02
10	250	15½	394	3.64	8.02

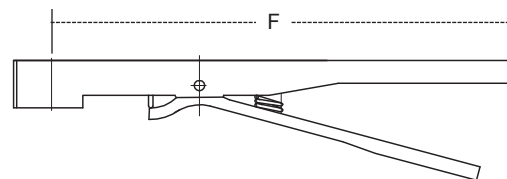

Series DBF (2" – 12"), BF (2" – 24")

Butterfly Valves

- For positive shutoff service on commercial, irrigation, HVAC and industrial applications

Specifications

***DBF** – Sizes 2" – 12" (50 – 300mm), pressure 200psi (13.8 bar) WOG
BF – Sizes 2" – 24" (50 – 600mm), pressure 200psi (13.8 bar) WOG for 2" – 12" (50 – 300mm) and 150psi (10.3 bar) for 14" – 24" (350 – 600mm)

Sample Ordering Number: 10-DBF-03-121-1G

10 = 10-inch (250mm) size; **DBF-03** = full lug style butterfly valve;
1 = cast iron body; **2** = aluminum bronze disc; **1** = 416SS shaft;
1 = EPDM seat; and **G** = gear operator

Designation Definitions: Add the appropriate designations required.

DBF for sizes: 2" – 12" (50 – 300mm)

BF for sizes: 2" – 24" (50 – 600mm)

Style

03 - Full lug

04 - Wafer

Body

1 - Cast Iron (ASTM-A126 Class B)

Disc

1 - Ductile Iron (ASTM-A126)

2 - Aluminum Bronze (ASTM-A296)

3 - 316 Stainless Steel (ASTM-A351)

Shaft

1 - 416 Stainless Steel *(316SS shaft on 316SS disc models)

Seat

1 - EPDM§ Temperature 5°F – 248°F (-15°C – 120°C)

2 - Buna-N Temperature -14°F – 176°F (-10°C – 80°C)

3 - Viton -4°F – 302°F (-20°C – 150°C)

§**Note:** Do not use EPDM when hydrocarbons are present.

Operator

0 - Bare shaft (no handle)

G** - Gear operator

5 - Lever handle (10-position), Sizes: 2" – 12" (50 – 300mm) only

P** - Positioning/locking kit with handle, Sizes: 2" – 12" (50 – 300mm) only



Features

- Full lug and wafer styles
- Cast iron body, 416 stainless steel shaft
- Mounting pad for 10-position lever, gear operator, or actuator
- Extended neck for 2" (50mm) of insulation
- Pinned disc
- Dead-end service rated lug style

For additional information, request literature ES-DBF or ES-BF.

Standards

For use with ANSI Class 125 or 150 flanges. Complies with API 609 and MSS-SP-67

Notes:

*DBF series butterfly valves use domestic and foreign components that have been assembled and tested in the U.S.A.

**Kits for suffix (G) gear operator & (P) positioning/locking service with handle are available.

Gear Operators – High mechanical efficiency reduces the required input effort. Two self-locking adjusting screws give a $\pm 5^\circ$ adjustment at end of 90° travel.

For additional information, request literature F-P/E-AC.

SIZE		DIMENSIONS (APPROX.)				TAPPED LUG DATA		†WEIGHT			
(DN)		A		G		N (Bolt)		(03) Full Lug		(04) Wafer	
in.	mm	in.	mm	in.	mm	in.	mm	lbs.	kgs.	lbs.	kgs.
2	50	10 ³ / ₄	273	3 ¹ / ₁₆	77	5/8-11UNCx1 ¹ / ₄	16x32	8	4	5	3
2 ¹ / ₂	65	11 ⁵ / ₈	295	3 ¹ / ₁₆	77	5/8-11UNCx1 ³ / ₈	16x35	10	5	7	4
3	80	12 ¹ / ₈	308	3 ¹ / ₁₆	77	5/8-11UNCx1 ³ / ₈	16x35	10	5	7	4
4	100	13 ⁵ / ₈	346	3 ⁵ / ₈	92	5/8-11UNCx1 ¹ / ₂	16x38	17	8	11	5
5	125	14 ⁵ / ₈	371	3 ⁵ / ₈	92	3/4-11UNCx1 ³ / ₄	19x44	23	11	16	8
6	150	15 ⁵ / ₈	397	3 ⁵ / ₈	92	3/4-11UNCx1 ³ / ₄	19x44	29	14	19	9
8	200	18 ⁷ / ₈	479	4 ¹ / ₂	115	3/4-11UNCx2 ¹ / ₈	19x54	39	18	30	14
10	250	21 ¹ / ₄	540	4 ¹ / ₂	115	7/8-11UNCx2 ¹ / ₄	22x57	61	28	45	21
12	300	24 ⁵ / ₈	625	5 ¹ / ₂	140	7/8-11UNCx2 ¹ / ₄	22x57	113	52	73	34
14	350	26 ³ / ₄	679	5 ¹ / ₂	140	1-8UNCx2 ¹ / ₄	25x57	154	70	97	44
16	400	30	762	7 ³ / ₄	197	1-8UNCx3 ³ / ₈	25x86	200	91	138	63
18	450	31 ¹ / ₂	800	7 ³ / ₄	197	1 ¹ / ₈ -7UNCx4	29x102	272	124	182	83
20	500	35 ⁵ / ₈	905	7 ³ / ₄	197	1 ¹ / ₈ -7UNCx5	29x127	396	180	260	118
24	600	43	1092	10 ⁷ / ₈	276	1 ¹ / ₄ -7UNCx5 ³ / ₄	32x146	610	277	465	211

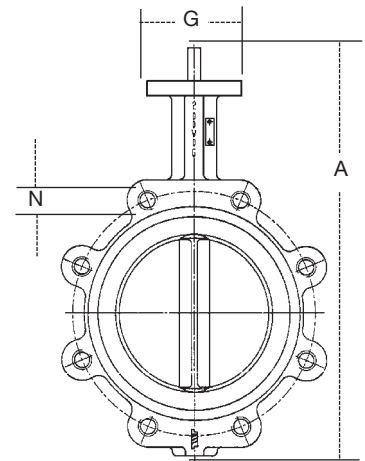

† Weights are for valves with stainless steel discs.

Weights for 2" – 12" have 10- position lever handles; 14" – 24" with bare stem

For additional dimensional data, request literature F-CDBF.

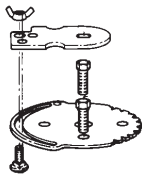

Positioning/Locking Kit

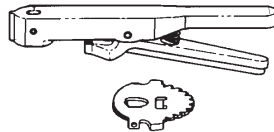

Standard Lever Handle/Latch Plate

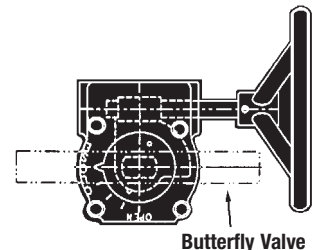

Butterfly Valve

Gear Operator

SIZE (DN)		GEAR OPERATOR	POSITIONING/LOCKING	CHAINWHEELS		
in.	mm	Kit No.	Kit No.	Kit No.	Chain	2" Sq. Nut
2	50	GA-1-M3	#1 POS-LOCK-M2	#2 BCWK	#2 BCWC	OPN-BFG
2 ¹ / ₂	65	GA-1-M3	#1 POS-LOCK-M2	#2 BCWK		OPN-BFG
3	80	GA-1-M3	#1 POS-LOCK-M2	#2 BCWK		OPN-BFG
4	100	GA-2-M3	#2 POS-LOCK-M2	#2 BCWK		OPN-BFG
5	125	GA-3-M3	#3 POS-LOCK-M2	#2 BCWK		OPN-BFG
6	150	GA-3-M3	#3 POS-LOCK-M2	#2 BCWK		OPN-BFG
8	200	GA-4-M3	#4 POS-LOCK-M2	#3 BCWK	#3 BCWC	OPN-BFG
10	250	GA-5-M3	#5 POS-LOCK-M2	#3 BCWK		OPN-BFG
12	300	GA-6-M3	#6 POS-LOCK-M2	#3 BCWK		OPN-BFG
14	350	GA-6-M3	N/A	#3 BCWK		OPN-BFG
16	400	GA-7-M3	N/A	#4 BCWK		----
18	450	GA-8-M3	N/A	#4 BCWK		----
20	500	GA-9-M3	N/A	#4 BCWK		----
24	600	GA-10-M3	N/A	#5 BCWK	#5 BCWC	----

Chain Wheel Kits attach to gear actuator handwheel.

2" (50mm) nuts are installed on gear operator shafts.

To operate Watts' butterfly valves with 2" (50mm) square nut, a gear operator must be used by removing gear handwheel and installing 2" (50mm) nut on gear shaft. Valve should be installed in line such that gear shaft is vertical for 2" (50mm) nut operation.

Series 1156F, 1450F (1/2")

Feed Water Pressure Regulators and Dual Controls for Hot Water Boilers

- Used on boiler feed lines to provide make up water to the system
- Highest capacity performance
- Unique unitized construction for ease of maintenance

Specifications

Feed water regulators

- Maximum Working Pressure: 100psi (689.5 kPa)
 - Maximum Temperature: 212°F (100°C)
 - Regulator set at 15psi (103.4 kPa), adjustment range 10-25psi (68.9-172.4 kPa)
- For additional information, request literature ES-1156 or ES-1450F.

MODEL	SIZE (DN)		DIMENSIONS (APPROX.)				WEIGHT	
	in.	mm	A		B		lbs.	kgs.
HIGH CAPACITY FEED WATER REGULATORS								
1156F	1/2	15	3 1/2	89	5 3/8	137	2.1	0.95
1156F-A	1/2	15	3 1/2	89	5 1/4	146	2.1	0.95
T1156F	1/2	15	4 1/4	108	5 3/8	137	2.2	1.0
S1156F	1/2	15	4 1/8	105	5 3/8	137	2.3	1.0
B1156F*	1/2	15	3 1/2	89	5 3/8	137	2.1	1.0
SB1156F*	1/2	15	4 3/8	108	5 3/8	137	2.2	1.0
TB1156F*	1/2	15	4 1/8	105	5 3/8	137	2.3	1.0
N256*	3/4	20	4	100	6 3/8	162	3.5	1.6
DUAL CONTROLS – REGULATOR AND RELIEF VALVE								
1450F	1/2	15	6 1/2	165	5 3/8	137	3.3	1.5
T1450F	1/2	15	7 3/8	184	5 3/8	137	3.3	1.5
S1450F	1/2	15	7	178	5 3/8	137	3.5	1.6
STRAINER, REGULATOR AND RELIEF VALVE								
T145B*	1/2	15	4	100	6 3/8	162	3.3	1.5
REGULATOR AND STRAINER								
T156B*	1/2	15	8 1/2	216	5 3/8	137	2.5	1.1

*Bronze Body

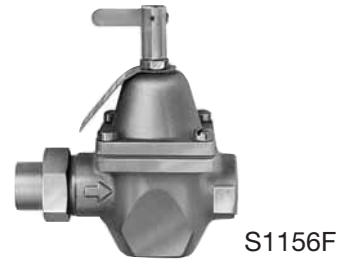

Models

- 1156F/1156F** – A NPT threaded inlet and outlet
- 1156F** – A 1/2" female bottom connection for installation of expansion tank
- S1156F** – union solder inlet
- T1156F** – union threaded inlet
- B1156** – bronze body with NPT threaded inlet and outlet
- SB1156F** – bronze body with union solder inlet
- TB1156F** – bronze body with union threaded inlet
- Series 1450F** – combines features of 1156F and rugged iron body diaphragm relief valve. Set @ 30psi

Features

- High capacity fast fill and purge capability
- Built-in check and strainer
- Iron and bronze construction

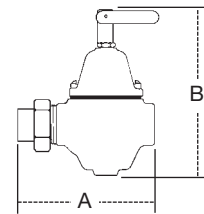

Series 911 (1/2")

Combination Backflow Preventer and Fill Valve for Hot Water Boilers

- Used on boiler supply feed lines to provide make-up water to the boiler and prevent backflow when supply pressure falls below system pressure
- An assembly of Watts 9D Backflow Preventer and 1156F feed water pressure regulator

Specifications

- Maximum Working Pressure: 100psi (689.5 kPa)
- Maximum Temperature: 212°F (100°C)
- Boiler fill valve set at 15psi (103.4 kPa) Adjustable range 10 – 25psi (68.9 – 172.4 kPa)

Models

- 911T** – NPT x NPT connections
- 911S** – solder x NPT connections
- B911 (T) (S)** – all bronze construction

For additional information, request literature ES-911.

MODEL	SIZE (DN)		DIMENSIONS (APPROX.)				WEIGHT	
	in.	mm	A		B		lbs.	kgs.
911T	1/2	15	8 1/2	216	5 1/4	133	4.2	1.9
911S	1/2	15	8 1/2	216	5 1/4	133	4.2	1.9
B911T	1/2	15	8 1/2	216	5 1/4	133	4.2	1.9
B911S	1/2	15	8 1/2	216	5 1/4	133	4.2	1.9



Features

- Pre-assembled for ease of installation
- Easy service accessibility
- High capacity fill valve for quick system filling and purging
- Size 1/2" x 1/2" (15 x 15mm)

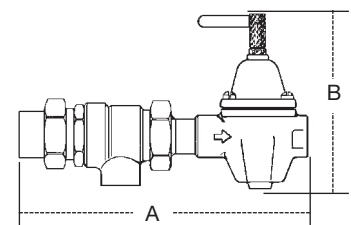

For assistance, contact your local authorized Watts agent or visit our website at www.watts.com

Series ET (1/2" – 3/4")

Non-potable Water Expansion Tanks for Hot Water Heating Systems

- Designed to control the thermal expansion of hot water in closed loop heating systems



ET-15

Specifications

- Maximum Working Pressure: 60psi (413.7 kPa)
- Maximum Temperature: 240°F (116°C)

Round expansion tanks: Model ET-15, 30, 60: Size: 1/2" (15mm); NPT male connection
ET-90: Size: 3/4" (20mm); NPT male connection

Option

add Suffix:

ASF – for one Model ET (expansion tank), one Model AS (air separator) and one Model FV-4 (float vent) in a package. Specify 1" (25mm) or 1 1/4" (32mm) size for air separator.

For additional information, request literature PG-ThermalExpansion.

For information on ASME rated tanks, request literature ES-ETA or ES-ET-RA.

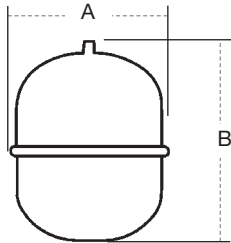

ET-15

MODEL	VOLUME		ACCEPTANCE		CONNECTION		DIMENSIONS (APPROX.)						WEIGHT	
	<i>gals.</i>	<i>liters</i>	<i>gals.</i>	<i>liters</i>	<i>in.</i>	<i>mm</i>	<i>in.</i>	<i>mm</i>	<i>in.</i>	<i>mm</i>	<i>in.</i>	<i>mm</i>	<i>lbs.</i>	<i>kgs.</i>
ROUND TANKS														
ET-15*	2.1	8	1.4	5.0	1/2	15	7 7/8	200	11 7/8	301	–	–	5.0	2.3
ET-30*	4.7	18	3.0	11.4	1/2	15	10 5/8	270	15	381	–	–	8.0	3.6
ET-60	6.6	25	4.3	16.0	1/2	15	12 1/4	311	15	381	–	–	14.0	6.4
ET-90	13.0	49	8.0	30.0	3/4	20	15	381	21 1/8	536	–	–	26.5	12.0

* Available in pallet quantities: ET-15 contains 78 pcs., ET-30 contains 48 pcs.

Series ETA 15 – ETA 240

ASME Pressurized Expansion Tanks for Heating and Cooling Systems

- Designed to absorb the expansion forces and control the pressure in heating and cooling systems
- ASME fixed bladder type precharged expansion tank



ETA

Specifications

- Maximum Design Pressure: ETA 15 through ETA 60: 150psi (10 bar). ETA 80 through ETA 240: 125psi (8.5 bar) Precharged to 12psi (83 kPa)
- Maximum Temperature: 240°F (115°C)

Features

- ASME Section VIII Construction
- Heavy Duty Butyl Bladder
- Precharged to 12psi (Field Adjustable)

Construction

Shell: Carbon steel
Bladder: Heavy duty Butyl
Exterior: Primer coated

For additional information, request literature ES-ETA.

Series ET-RA 35 – ET-RA 2000

ASME Pressurized Expansion Tanks for Heating and Cooling Systems

- Designed to absorb the expansion forces and control the pressure in heating and cooling systems
- ASME removable bladder type pre-charged expansion tank



ET-RA

Specifications

- Maximum Design Pressure: 125psig* (8.5 bar).
- Maximum Design Temperature: 240°F (115°C). Precharged to 12psi (83 kPa).

*200 and 250psig available.

Features

- ASME Section VIII Code Construction
- Removable Butyl Bladder
- Precharged to 12psi (Field Adjustable)

Construction

Shell: Carbon steel
Bladder: Heavy duty Butyl
Exterior: Primer coated
 For additional information, request literature ES-ET-RA.

Series ETX, ETSX (1/2" – 1 1/4")

Pressurized Expansion Tanks for Heating and Cooling Systems*

- Designed to absorb the thermal expansion of hot water in closed loop heating systems.

Features

- Precharged at 12psi (82.7 kPa)
- Rugged flexible butyl diaphragm
- In-line and free standing models
- Compatible with glycol in systems
- Steel construction

Models

- ETX Mounts to supply piping
 ETSX Free standing

Ratings

Maximum Working Temperature: 240°F (115°C)

Maximum Working Pressure:

ETX-15, ETX-30, ETX-60: 75psi (517 kPa)

ETX-90 and ETSX Series: 100psi (6.9 bar)

Precharge (field adjustable): 12psi (82.7 kPa)



ETX



ETSX

Dimensions – Weights

MODEL	TANK VOL.	ACCEPT. VOL.	CONNECTION	DIAMETER		HEIGHT		WEIGHT	
	gal.	@12 psi		in	mm	in	mm	lbs.	kgs.
ETX-15	2.1	1.0	1/2" MNPT	8	203	12 1/2	318	5.0	2.3
ETX-30	4.5	2.5	1/2" MNPT	11	279	14	356	10.0	4.54
ETX-60	6.0	3.0	1/2" MNPT	11 3/8	290	17 3/16	437	11.5	5.22
ETX-90	15.0	6.0	3/4" MNPT	16	406	20 13/16	528	28.0	12.70
ETSX-30	15.0	6.0	1" FNPT	16	406	21 11/16	551	32.0	14.51
ETSX-40	20.0	8.0	1" FNPT	16	406	28 13/16	732	39.0	17.69
ETSX-60	33.0	13.3	1" FNPT	16	406	42 13/16	1087	57.0	28.85
ETSX-90	44.0	17.7	1 1/4" FNPT	21	533	36 3/16	919	72.0	32.66
ETSX-110	62.0	24.9	1 1/4" FNPT	21	533	47 7/8	1217	112.0	50.80
ETSX-160	81.0	32.6	1 1/4" FNPT	21	533	62	1575	123.0	55.79

*Not for use on potable water systems

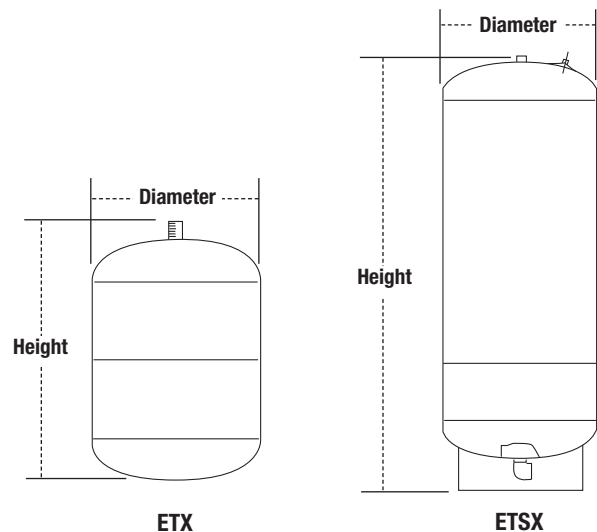

ETX

ETSX

Combination Packages

Series HP – includes air separator, 1/8" and 1/2" (3 and 15mm) service check valves, float vent, fill valve (some models include combination fill valve and backflow preventer) and expansion tank

Series HP Bronze – includes bronze air separator, (2) 1/2" (15mm) service check valves, 1/2" (15mm) FV-4M1 float vent, bronze combination fill valve and backflow preventer and expansion tank

Series HPP – boiler trim out package

Series ET-ASF – includes air separator, float vent, and expansion tank

For additional information request literature PG-HHS.



MODEL	AIR SEPARATOR		SERVICE CHECK VALVE		FLOAT VENT		FILL VALVE B1156	FILL VALVE / BACKFLOW PREVENTER		FLOW CHECK 2000-M5 1" 25mm	EXPANSION TANK			
	1" 25mm	1 1/4" 32mm	1/8" 3mm	1/2" 15mm	FV-4M1 1/8" 3mm	DUO VENT 1/8" 3mm		911S	B911S		ET-15	ET-30	ET-90	
SERIES HP — BOILER TRIM-OUT PACKAGES												ET-15	ET-30	ET-90
HP-C	X		X	X	X			X					X	
HP-D		X	X	X	X			X					X	
HP-15C	X		X	X	X			X			X			
HP-15D		X	X	X	X			X			X			
HP-30 BC	X		X	X		X			X				X	
HP-30 BD		X	X	X		X			X				X	
HP-15 BC	X		X	X		X			X		X			
HP-15 BD		X	X	X		X			X		X			
HP-15 BF		X	X	X	X		X				X			
HP-30 BF		X	X	X	X		X						X	
HPP	X		X	X	X			X		X			X	
SERIES HPX — EXPANSION TANK TRIM-OUT PACKAGES												ETX-15	ETX-30	
HPX-C	X		X	X	X			X					X	
HPX-D		X	X	X	X			X					X	
HPX-15C	X		X	X	X			X			X			
HPX-15D		X	X	X	X			X			X			
HPX-30 BC	X		X	X		X			X				X	
HPX-30 BD		X	X	X		X			X				X	
HPX-15 BC	X		X	X		X			X		X			
HPX-15 BD		X	X	X		X			X		X			
SERIES ET-ASF — COMBINATION PACKAGES												ET-15	ET-30	ET-90
ET-15-ASF	X				X								X	
ET-15-ASF		X			X								X	
ET-30-ASF	X				X								X	
ET-30-ASF		X			X								X	
ET-60-ASF	X				X									X
ET-60-ASF		X			X									X
SERIES ETX-ASF — COMBINATION PACKAGES												ETX-15	ETX-30	
ETX-15-ASF	X				X								X	

SERIES HP BRONZE — BOILER TRIM OUT PACKAGES											
MODEL*	AIR SEPARATORS				SERVICE CHECK VALVE	FLOAT VENT	FILL VALVE/ BACKFLOW PREVENTER	EXPANSION TANK			
	AS-B-S		AS-B-T					ET-15	ET-30		
	1" (25mm)	1 1/4" (32mm)	1" (25mm)	1 1/4" (32mm)	1/2" (15mm)	FV-4M1 1/2" (15mm)	B911S 1/2" (15mm)	1/2" (15mm)	1/2" (15mm)		
HP-15C-AB-S	X				2	X	X	X			
HP-15D-AB-S		X			2	X	X	X			
HP-15C-AB-T			X		2	X	X	X			
HP-15D-AB-T				X	2	X	X	X			
HP-30C-AB-S	X				2	X	X		X		
HP-30D-AB-S		X			2	X	X		X		
HP-30C-AB-T			X		2	X	X	X	X		
HP-30D-AB-T				X	2	X	X		X		
SERIES HPX BRONZE — EXPANSION TANK TRIM OUT PACKAGES											
HPX-15C-AB-S	X				2	X	X	X			
HPX-15D-AB-S		X			2	X	X	X			
HPX-15C-AB-T			X		2	X	X	X			
HPX-15D-AB-T				X	2	X	X	X			
HPX-30C-AB-S	X				2	X	X		X		
HPX-30D-AB-S		X			2	X	X		X		
HPX-30C-AB-T			X		2	X	X	X	X		
HPX-30D-AB-T				X	2	X	X		X		

*S = Solder air separator, T = threaded air separator end connections.

Series RPV (3/4", 1", 1 1/4")

Residential Purge and Balancing Valves

- Provides a unique and low cost solution for start-up purging and balancing of hydronic heating loops.
- Rugged, dual-ball valve design
- High-volume purging
- Accurate balancing and drip tight shutoff

Specifications

- 3/4" solder and threaded connections
- 1" and 1 1/4" solder connection
- Maximum Working Pressure: 50psi (344 kPa)
- Maximum Inlet Temperature: 250°F (121°C)

For additional information, request literature ES-RPV.

Features

- One-piece convenience — no extra assembly required
- Maximum air purging — purges 500 foot loop in 10 seconds
- Positive shutoff dual-ball valve design — drip tight seal on balance port maximizes effectiveness of purging
- Hose thread connection for purge

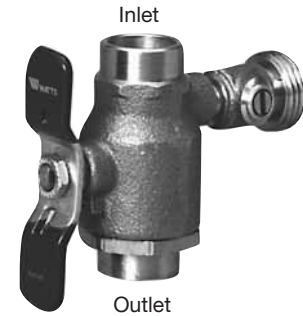

RPV

Models

RPV- with 180° relief port

RPV-S-90 – with 90° relief port

RPV-SM-90 – with 90° relief port and sweat x male connections

MODEL	INLET X OUTLET	SIZE (DN)		DIMENSIONS (APPROX.)								WEIGHT	
		in.	mm	B		C		D		E		lbs.	kgs.
RPV-S	Solder x Solder	3/4	20	2 15/16	75	2 3/8	60	1 1/16	17	1 3/4	44	1.1	0.5
RPV-T	FNPT x FNPT	3/4	20	2 15/16	75	2 3/8	60	1 1/16	17	1 3/4	44	1.2	0.5
RPV-TS	FNPT x Solder	3/4	20	2 15/16	75	2 3/8	60	1 1/16	17	1 3/4	44	1.2	0.5
RPV-ST	Solder x FNPT	3/4	20	2 15/16	75	2 3/8	60	1 1/16	17	1 3/4	44	1.2	0.5
RPV-S	Solder x Solder	1	25	3 3/4	95	2 3/8	60	7/8	22	2 3/8	60	1.2	0.5
RPV-S	Solder x Solder	1 1/4	32	4 1/2	114	2 7/8	73	1 1/16	27	2 7/8	73	1.2	0.5

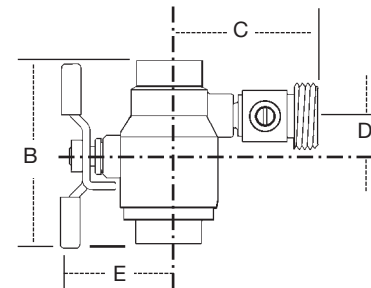

Series AS, AS-T (1" – 3")

Air Separators for Removing Air from Water in Hydronic Heating Systems



AS-T



AS

- Efficient separation of air
- Heavy cast iron construction
- Provides complete, continuous, purging and venting of air in the hot water heating system when installed in conjunction with the Watts Model ET expansion tank and Model FV4 float-vent
- AS model includes 1/2" tapping for fill valve piping

Specifications

- Maximum Working Pressure: 125psi (8.6 bar)
- Maximum Temperature: 275°F (135°C)

For additional information, request literature S-AS/AST.

AS – Sizes 1", 1 1/4", 1 1/2", 2", 2 1/2", 3" (25 – 80mm), NPT female inlet/outlet connections. With 1/8" (3mm) female threaded connection for float vent and 1/2" (15mm) female threaded connection for expansion tank.

AS-T – Sizes 1" and 1 1/4" (25 – 32mm), with 1/2" feed water tapping

Series AS-B

Bronze Air Separator

- Bronze construction
- Sizes 3/4", 1", 1 1/4" (20, 25, 32mm) NPT, sweat or threaded inlet/outlet connections
- Standardly furnished with tappings for boiler fill, expansion tank and air vent
- Comes standard with 1/2" (15mm) Watts model FV4-M1 float vent to provide complete, continuous purging and venting of air in the system

Specifications

- Maximum Working Pressure: 125psi (862 kPa)
- Maximum Operating Temperature: 275°F (135°C)

For additional information, request literature ES-AS-B.



AS-B-T

Models

AS-B-S – sweat connections

AS-B-T – threaded connections

Series DuoVent (1/8" – 1/4")

High Capacity Air Vent with Manual Vent Feature

Provides automatic air venting for hot or cold water distribution systems. The vent feature provides tremendous air elimination capability for lightening fast venting of residential and commercial systems.

The DuoVent valve utilizes a float to actuate the valve plug which is located at the top of the valve. Once the air is displaced and the system pressure is sustained, the valve plug seals and prevents any water from escaping from the system.

The float vent can also operate as an anti-vacuum device since it will permit air to enter the system when it must be drained.



DuoVent

Specifications

- Sizes: 1/8", 1/4" (3, 8mm) NPTF
- Maximum Working Temperature: 240°F (116°C)
- Minimum Working Pressure: 1.45psi (10 kPa)
- Maximum Working Pressure: 150psi (10.3 bar)

For additional information, request literature ES-DuoVent.

Maintenance

No maintenance is normally necessary. However, the DuoVent can be disassembled for inspection or cleaning.

Features

- Body and cover are brass construction
- Air vent with silicone rubber seal
- Impurities do not usually affect functioning as max. float line of water is always lower than the valve seal
- Float is high temperature resistant polyethylene
- Suitable for use with glycol systems

MODEL	SIZE (DN)		DIMENSIONS (APPROX.)						WEIGHT					
	in.	mm	A	B	C	D	D1	lbs.	kgs.					
DuoVent	1/8	3	1 5/16	33	3	76	2 11/16	68	5/16	8	5/16	8	4.2	119
DuoVent	1/4	8	1 5/16	33	3 1/8	79	2 11/16	68	7/16	11	5/16	8	4.2	119

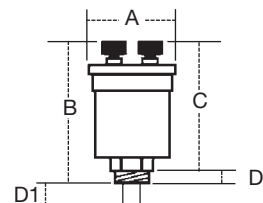

Series FV-4M1 (1/8" – 1")

Automatic Vent Valve

- Provides automatic air venting for hot or cold water distribution systems
- Purges air that may be in the water system

Specifications

- Sizes 1/8" – 1" (3 – 25mm) NPTF
- Max. Working Temp.: 240°F (116°C)
- Min. Working Pressure: 1.45psi (10 kPa)
- Max. Working Pressure: 150psi (10.3 bar)
- Float is high temperature resistant polyethylene
- Suitable for use with glycol systems

For additional information, request literature ES-FV4-M1.

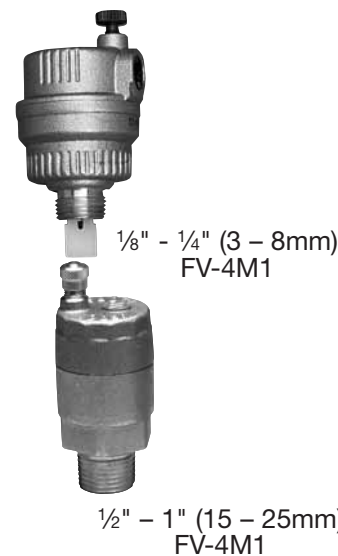

Series P3 (1/2")

Multi-orifice Flow Control for Tankless Heaters

- Designed to limit the flow of water to equipment
- Used for tankless heater installations

Specifications

- Maximum Pressure: 150psi (10.3 bar)
- Maximum Temperature: 250°F (121°C)

Size 1/2" (15mm), solder connection. Multi-orifice cylinder, adjusts to 2.5, 3, 3.5 or 4 gpm (10, 11, 13 or 15 lpm)



P3

For additional information, request literature ES-P3.

Series HAV (1/8", 1/4")

Automatic Vent for Hot Water Heating Systems

- The HAV valve utilizes moisture retaining discs to control air release. As discs dry they allow air to escape, when wet they provide positive shutoff
- Positive shutoff ball check
- Heat resistant handwheel
- Simple two piece construction

Specifications

- Sizes 1/8" (3mm) and 1/4" (8mm)
- Working Pressure: minimum 1.45psi (10 kPa), maximum 125psi (8.6 bar)

- Water Temperature: minimum 140°F (60 °C), maximum 240°F (116 °C)
- Suitable for water only additives: only inhibited glycol based additives are permissible

For additional information, request literature ES-HAV.



HAV

Series IPF-M1 (1/2" – 2")

Isolation Pump Flanges for Circulator Pumps

- Ball Valve isolation for circulator pumps
- Adjustable packing gland
- Brass body & flange
- Optional T handle included
- Available with threaded or solder connections
- Sizes 1/2" – 2" (15 – 50mm) Sweat (IPF-S-M1), 1/2" - 2" (15 – 50mm) Threaded (IPF-T-M1)

Specifications

- Maximum working Pressure: 600psi (41.3 bar) WOG

Models

IPF-T – 1/2" (15mm) NPT threaded end connection

IPF-S – 1/2" (15mm) Solder end connection

IPF-T-M1 – 3/4" - 2" (20-50mm) NPT threaded end connection

IPF-S-M1 – 3/4" - 2" (20-50mm) Solder end connection



IPF-S-M1



IPF-T-M1

For additional information, request literature ES-IPF

Series PIPF (3/4" – 1 1/4")

Isolation Pump Flanges with Purge Port & Swivel Flange

- Ball valve isolation for circulator pumps
- Integral purge port saves time and money compared to purge stations made with ball valves, boiler drains and copper tees
- Swivel flange allows purge port to be positioned for optimal purging convenience
- Brass body & flange
- Double O-ring stem sealing technology eliminates packing leaks
- Available with threaded or solder end connections

Specifications

- Maximum Working Pressure: 400psi (27.6 bar) WOG



PIPF-T

For additional information, request literature ES-PIPF

Series 2000-M5 (3/4" – 3")

Hydronic Two-way Universal Flow Checks

- For forced hot water heating systems to provide positive gravity shutoff when circulator is not running

Specifications

- Maximum Working Pressure: 50psi (344.8 kPa) for sizes 3/4" – 1 1/4" (20 – 32mm)
- Maximum Working Pressure: 125psi (8.6 bar) for 1 1/2" – 3" (40-80mm)
- Maximum Temperature: 250°F (121°C)

Models

2000-M5 – combines angle and horizontal checks, sizes 3/4" – 3" (20 – 80mm), iron

body construction. Sizes 3/4" – 1 1/2" (20 – 40mm) have female threaded connections. Sizes 2" – 3" (50 – 80mm) have one flanged outlet x two female threaded connections. One connection can be used for the installation of an expansion tank when installed at angle check.

2000S-M5 – straight pattern, sizes 3/4" – 1" (20 – 25mm), bronze body construction, solder inlet and outlet connections.



2000-M5



2000S-M5

For additional information, request literature ES-2000.

Series G, GH, MG, MGH (1/2" – 1")

Thermostatic Steam Traps

- Removes condensate, air and non-condensable gases from heating systems to conserve steam

Specifications

- Balanced pressure duplex phosphor bronze diaphragm sensitive within 3°F (-16°C)
- Stainless steel valve seat
- Diaphragm and seat both replaceable

Models

G and GH – for low pressure and vacuum heating applications (25" Hg Vacuum to 25psi)

MG and MGH – for medium pressure and vacuum heating applications (25" Hg Vacuum to 65psi)



1GAP

For additional information, request literature ES-G/GH/MG/MGH.

Series QF

Quik-Fix™ Radiator Steam Trap Replacement Kits

- Quick, easy and economical radiator trap repair kit
- Simplifies and standardizes inventory
- Upgrades old radiator traps instantly
- Adapts to most existing radiator traps
- Uses existing cover

For additional information, request literature ES-QF.

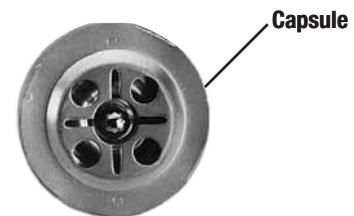

QF



Replaceable Seats



Integral Seats

QUICK, EASY INSTALLATION		
1	2	3
Remove cover of trap and old trap parts.	Install seat adapter, then snap capsule onto it.	Replace original cover.

Series G, MG (3/4" – 2")

Float and Thermostatic Steam Traps

- Fail safe operation – in case of float failure, trap discharges condensate and air
- Air vent parts accessible without disturbing piping
- Straight-through connections save installation time, labor, space, headroom

Specifications

- Stainless valve head and seats
- Seamless copper float
- Condensate valve rotates to ensure even wear, longer valve and seat life

Models

6G-15 through 111MG-15 – for steam main drip and process equipment applications (25" Hg to 15psi, 103 kPa)

7MG-30 through 111MG-30 – for steam main drip and process equipment (25" Hg to 30psi, 207 kPa)

6MG-50 through 111MG-50 – for steam main drip and process equipment applications (25" Hg to 50psi 345 kPa)



6G

For additional information, request literature ES-G/MG.

Series WIB (1/2" – 1")

Inverted Bucket Steam Traps

- Designed for reliable condensate removal on virtually all types of steam equipment

Specifications

- Maximum Working Pressure: 250psi (17.2 bar)
- 1/2"- 1" (15-25mm) pipe sizes
- Working parts removable without disturbing piping

Models

WIB 80 – 1/2"-3/4" (15-20mm) for operating pressures up to 150psi (10.3 bar)

WIB 81 – 1/2"-1" (15-25mm) for operating pressures up to 250psi (17.2 bar)



WIB

Inverted Bucket Traps have very limited air venting capabilities and it is recommended that an auxiliary air vent be utilized if any quantity of air is anticipated.

For additional information, request literature for ES-WIB.

Series WFT (3/4" – 2")

Float & Thermostatic Steam Traps

- Designed to provide continuous air venting and separate condensate draining with maximum efficiency
- "H" pattern body on all 3/4", 1", 1 1/4" (20, 25, 32mm), has been designed to offer maximum installation flexibility
- Larger sized traps, 1 1/2", 2" (40, 50mm), the inlet and outlet taps are located in the cover, allowing for the larger capacities needed
- Traps can be serviced without disturbing system piping

Specifications

- Valve and seat combinations 15, 30, 75, (103, 207, 517 kPa) 125psi (8.6 bar) differential pressures
- Maximum Working Pressure: 250psi (17.2 bar) @ 406°F (673°C)
- All stainless steel internal components
- All stainless steel balanced pressure thermostatic air vent
- Wide selection 3/4" – 2" (20 – 50mm)



WFT

For additional information, request literature ES-WFT.

Series WFTC (3/4" – 1 1/4"), WFTK (1 1/2" – 2")

Float and Thermostatic Steam Trap Cover Assemblies and Repair Kits

- High quality replacement kits for Spirax Sarco FT series steam traps

Models

WFTC – Sizes: 3/4" - 1 1/4" (20 – 32mm), cover assembly consisting of a complete, factory assembled unit consisting of cover, cover gasket, condensate valve, float, linkage and thermostatic vent which simply bolts on for ease of repair. No pipe connections need to be broken; no reduction in the trap's capacity.

WFTK – Sizes: 1 1/2" – 2" (40 – 50mm), complete kit contains a thermostatic air vent, float, linkage, valve, seat and cover gasket. Used for large traps having piping connections into the cover plate.



WFTC

For additional information, request literature ES-WFTC/WFTK.

Series WTD-600 (3/8" – 1")

Thermodynamic Steam Traps

- Designed to drain steam mains, steam tracing lines, and small process equipment efficiently
- Discharges condensate at near to steam temperature

Specifications

WTD-600 – Sizes: 3/8" – 1" (10 – 25mm), NPT female threaded connections
Maximum Working Pressure: 600psi (41.3 bar)



WTD-600

For additional information, request literature ES-WTD.

Series RA (1/2" – 2")

Steam Radiator Valves

- Teflon® stem packing

Models

RA-1-AP – 1/2" – 2" (15 – 50mm), angle valves, bronze body, FIP x male union connections

RA-2-AP – 1/2" – 1 1/4" (20 – 32mm), angle valve, brass body, FIP x male union connections

RA-CV – 1", 1 1/4" (25, 32mm), angle convector valve, bronze body, female union x FIP connections

RA-1-SW – 1/2" – 1 1/2" (15 – 40mm), gate valve with FIP x male union connections



RA-1-AP

For additional information, request literature ES-RA-1-AP, ES-RA-1-SW, ES-RA-2-AP, or ES-RA-CV.

Series SV (1/8" – 3/4")

Steam Air Vents

- Designed to vent air on non-vacuum steam heating systems
- Used on radiators, convectors, and steam mains

Models

SV – Size: 1/8" (3mm) non-adjustable angle connection

SVA – Size: 1/8" (3mm), adjustable angle connection

SVS-1 – Size: 1/8" (3mm), non-adjustable straight connection

SVS-2 – Size: 1/4" (8mm), non-adjustable straight connection

SVS-3 – Size: 3/4" male inlet or 1/2" female inlet connection (20 or 15mm), non-adjustable straight connection



SVA

For additional information, request literature ES-SV.

Series FS10-C, FS-20 (1")

Paddle-type Flow Switches Actuated by Liquid Flow

- For automatic controls or safety devices
- Used to monitor liquid flow in pipelines servicing water and heating systems, air conditioning and processing installations

Specifications

- Maximum Working Pressure: 150psi (10.3 bar)
- Maximum Temperature: 300°F (149°C)

Models

FS10-C – Size: 1" (25mm), NPT male connection, standard unit.

FS10-CL – Size: 1" (25mm), NPT male connection, standard unit with indicator light.

FS-20 – Nema 4X rated water-tight, dust-tight and corrosion resistant enclosure provides an accurate monitoring of flow in pipelines servicing outdoor or wet applications. Sizes: 1" (25mm), NPT male connection. Maximum pressure 150psi (10.3 bar). Maximum temperature 300°F (149°C).



FS10-CL

For additional information, request literature F-FS10C/FS10F/FS20.

Series FS10-F (1")

Water Flow Detectors for Automatic Fire Protection Sprinkler Service

- UL listed/FM/ULC approved. For use on fire sprinkler branch lines

Specifications

- Maximum Working Pressure: 175psi (12.1 bar)
- Maximum Temperature: 300°F (149°C)
- Factory set and sealed for flow rate of 4-10 gpm (15.2-38 LPM)

Models

FS-10F/FS-10-FL – Size: 1" (25mm), NPT male connection. For pipe sizes 1", 1¼" or 1½" (25, 32 or 40mm) using standard ASTM tees; FL model has indicator light.

For additional information, request literature F-FS10C/FS10F/FS20.

Series N50 (1")

Low Water Cut-offs

- Protects hot water heating boilers against emergency low water conditions
- Used on low pressure process boilers

Specifications

- Float chamber has 1" (25mm) NPT female top and bottom connections.

Models

N50S – Single switch assembly for burner service with extra terminal for line voltage single pole, double throw service

N50D – Dual switch assembly for line voltage burner service and independent low (or high) voltage alarm, feed valve or pump starter



N50

For additional information, request literature IS-N89.

Series 142, 144 (1/2")

Boiler Water Feeders for Process Boilers

- Used on pressing machines and other small process boilers

Specifications

- Maximum Steam Pressure: 100psi (689.5 kPa)
- Maximum Water Pressure: 125psi (8.6 bar)

Note: The water pressure must be at least 10psi (68.9 kPa) higher than steam pressure.

Models

142 – Used on pressing machines when feed through float chamber is permissible. Direct feed through float chamber.

142S – With strainer.

144 – Water is fed automatically as needed to maintain the correct water operating level in boiler. External water feed connections. Water feed connection 1/2" (15mm) NPT female. Float chamber connection 1" (25mm) NPT female.

144S – With strainer.



142

For additional information, request literature IS-142.

Series SAN89, SAN50 (1/2", 1")

Float and Switch Assemblies for Servicing Low Water Cut-offs

- One piece unit facilitates installation and assures user of the most up-to-date construction

Models

SAN89D – Complete float and dual switch assembly. Maximum steam pressure 15psi (103.4 kPa).

SAN89S – Same as above, but with single switch assembly for Watts N89S and N101S.

SAN50D – Complete assembly with dual switch. Maximum boiler pressure 50psi (344.8 kPa).

SAN50S – Same as above, but furnished with single switch assembly.



SAN89

For additional information, request literature IS-N89.

Series HBV (1/2" – 1")

Hydronic Balancing Ball Valves

- Used with forced hot water systems

Specifications

- Sizes 1/2" – 1" (15 – 25mm), solder x solder connections
- Maximum Working Pressure (non-shock) 600psi (41.3 bar) WOG



HBV

For additional information, request literature ES-HBV.

Series HWA (1/2" – 1 1/2")

Bronze Hot Water Angle Valves

- Used on gravity (hot water) heating systems only

Specifications

- Maximum Working Pressure: 60psi (4.2 bar) non-shock for hot water

Models

HWA – Sizes 1/2" – 1 1/4" (15 – 32mm), FIP female x threaded male union. Sizes 1/2" & 3/4" (15 & 20mm), bronze body, solder x threaded male union connections



HWA

For additional information, request literature ES-HWA.

Series OTV (1/2")

Oil Tank Valves

- Metal to metal seats
- Heavy duty brass construction
- Screwed bonnet
- Rising stem

Specifications

- Maximum Working Pressure: WOG 125psi (8.6 bar)

Models

OTV-FL – Sizes 1/2" (15mm) male connection x 3/8" (10mm) female connection
OTV-M – Sizes 1/2" (15mm) male connection x 3/8" (10mm) male connection



OTV

For additional information request literature ES-OTV.

Series UL (1/2" – 1 1/4")

Bronze Union Elbows for Steam/Hot Water Systems

- Pressure-tested elbow.

Specifications

- Working Pressure non-shock saturated steam: 15psi (103.4 kPa), hot water 60psi (413.7 kPa)

Models

UL-1 – Sizes: 1/2" – 1 1/4" (15 – 32mm), FIP female threaded x male threaded union
UL-2 – Sizes: 1/2" & 3/4" (15 and 20mm), solder x male union connections



UL-1

For additional information, request literature ES-UL.

Series USG-B (3/8")

Under Sink Guardian™ Professional

- Designed for the Plumbing Professional for single fixture protection
- ASSE 1016 listed, CSA B-125 Certified
- Heavy-duty brass body with 3/8" compression fittings that accommodate the supply lines used in most kitchen sinks or bathroom lavatories
- Quickly installs between stop valves and faucets
- Maintain, ±3°F mixed water temperatures up to maximum outlet temperature of 120°F when limit stop is properly set
- Built-in check valves prevent cross-flow and integral strainers filter out debris
- Includes locking cap

Specifications

- Minimum Supply Pressure Required: 30psi (207 kPa)
- Minimum Flow Rate Required: 0.5 gpm (1.9 lpm)
- Hot Inlet Temperature: 120°F – 180°F (49°C – 82°C)
- Cold Inlet Temperature: 40°F – 85°F (4°C – 29°C)
- Minimum Inlet Temperature Differential: 15°F (9°C)
- Temperature Adjustment Outlet: Range 80°F – 120°F (27°C – 49°C)
- Maximum Inlet Temperature: 180°F (82°C)
- Maximum Working Pressure: 150psi (10.3 bar)



USG-B-M1
Patent# 6,315,209

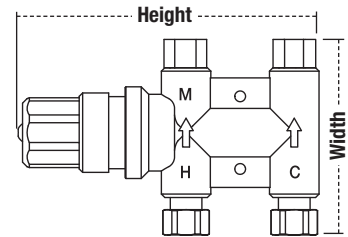

For additional information, request literature ES-USG-B.

MODEL	FINISH	CONNECTION SIZE	HEIGHT		WIDTH		WEIGHT	
			in.	mm	in.	mm	lbs.	kgs.
USG-B-M1	Bronze	3/8" Compression	5 3/16	132	3 1/8	79	1.5	0.68
USG-B-SC-M1	Satin Chrome	3/8" Compression	5 3/16	132	3 1/8	79	1.5	0.68

*Now includes integral strainers.

Series USG-P

Under Sink Guardian™

- ASSE 1016 listed, CSA B-125 Certified
- Thermoplastic body with 3/8" compression fittings that accommodate the supply lines used in most kitchen and bathroom lavatories
- Quickly installs between stops valves and faucets
- Maintain, ±3°F mixed water temperatures up to maximum outlet temperature of 120°F when limit stop is properly set
- Built-in check valves prevent cross-flow and intergral strainers filter out debris
- Includes tamper resistant locking cap

Specifications

- Minimum Supply Pressure: 30psi (207 kPa)
- Hot Inlet Temperature: 120°F – 180°F (49°C-82°C)
- Cold Inlet Temperature: 40°F – 85°F (4°C-29°C)
- Minimum Inlet Temperature Differential: 15°F (9°C)
- Temperature Out: 80°F – 120°F (27°C – 49°C)
- Maximum Working Pressure: 150psi (10.3 bar)



USG-P-M1
Patent# 6,315,209

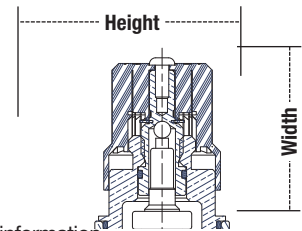

For additional information, request literature ES-USG-P.

MODEL	FINISH	CONNECTION SIZE	HEIGHT		WIDTH		WEIGHT	
			in.	mm	in.	mm	lbs.	kgs.
USG-P-M1	Thermoplastic	3/8" Compression	5 3/16	132	3 1/8	79	1.5	0.68

Also Available:

USG-DP-M1 – Complete installation kit in display packaging, includes two each of the following:

- 3/8" x 3/8" x 12" compression x compression flexible braided pvc connectors
- 3/8" x 1/2" No 66-CP adapters
- 1/16" x 1/2" adapters
- Ferrule for use with pex or polybutylene supply tubing



USG-DP-M1

Series MMV-M1 (1/2" - 1")

Thermostatic Mixing Valves

- For use in domestic water systems at the point of use to provide accurate outlet temperature control
- ASSE 1016 listed, ASSE 1017 listed and ASSE 1070 listed, CSA B-125 Certified

Specifications

- Bronze body
- Maximum Temperature: 200°F (93°C)
- Maximum Working Pressure: 150psi (10.3 bar)
- Outlet Temperature: Ranges from 80°F - 120°F (27°C - 49°C) adjustable

End Connection Options

add Suffix:

- UT** – union thread connections
- US** – union solder connections
- PEX** – union PEX connections
- CPVC** – union CPVC connections
- QC** – union Quick-Connect connections



MMV-M1

For additional information, request literature ES-MMV.

SIZE (DN)		MODEL	DIMENSIONS						WEIGHT	
			A		B		C			
in.	mm		in.	mm	in.	mm	in.	mm	lbs.	kgs.
1/2	15	MMV-UT-M1	4 7/8	124	5 7/16	137	3 3/16	80	1.5	.68
3/4	20		4 7/8	124	5 7/16	137	3 3/16	80	1.6	.73
1	25		5 5/16	135	5 5/8	143	3 3/8	86	1.6	.73
1/2	15	MMV-US-M1	4 13/16	123	5 3/8	137	3 3/8	80	1.5	.68
3/4	20		5 5/16	135	5 5/8	143	3 3/8	86	1.6	.73
1	25		5 13/16	148	5 7/8	149	3 3/8	92	1.6	.73
1/2	15	MMV-PEX-M1	5 1/4	133	5 9/16	142	3 5/16	85	1.5	.68
3/4	20		5 1/2	140	5 11/16	145	3 7/16	88	1.6	.73
1	25		5 7/8	149	5 7/8	150	3 3/8	93	1.6	.73
1/2	15	MMV-CPVC-M1	4 3/4	121	5 5/16	136	3 1/16	79	1.5	.68
3/4	20		5 1/4	133	5 9/16	142	3 5/16	85	1.6	.73
1	25		5 11/16	144	5 13/16	147	3 3/16	90	1.6	.73
1/2	15	MMV-QC-M1	6 5/8	168	6 1/4	159	4	102	2.17	.98
3/4	20		6 15/16	177	6 1/16	163	4 3/16	106	2.88	1.31
1	25		7 7/8	181	6 1/2	165	4 1/4	108	3.65	1.66

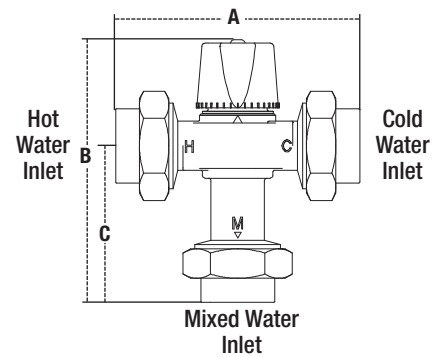

Model L111 (1/2")

Thermostatic Mixing Valve

- Maintains desired mixed water temperature at point of use for single showers or lavatories
- ASSE 1016 listed
- Brass body construction with polyetherimide control cartridge and polypropylene tamper-resistant cover to ensure long life

Specifications

- 1/2" (15mm) threaded female inlet and outlet
- Minimum Working Pressure: 15psi (103 kPa)
- Maximum Working Pressure: 125psi (8.6 bar)
- Temperatures for inlets: hot, 120°F to 180°F (49°C - 82°C); cold, 33°F to 85°F (0.5°C - 29°C)
- Minimum Differential Temperature: 10°F (-12°C)
- Outlet Temperature: ranges from 80°F to 120°F (27°C - 49°C); adjustable by contractor; accurate within ±3°F (±1.7°C)

For additional information, request literature ES-L111.

Options

add Suffix:

CS-U – integral check, strainer, and stop valves. Sizes: 1/2", 3/4", 1" (15 - 25mm)



L111 (shown with CS-U Check Stops Installed)

MODEL	SIZE (DN)		DIMENSIONS (APPROX.)						WEIGHT	
	in.	mm	A		B		D		lbs.	kgs.
			in.	mm	in.	mm	in.	mm		
L111	1/2	15	3	76	4	102	1 1/16	175	3.5	1.5

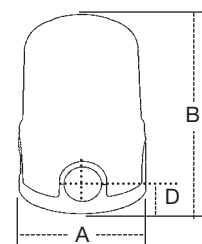

Series 1170-M2, L1170-M2 (1/2" - 1")

Hot Water Temperature Control Valves

- Mixes hot and cold water in domestic hot water systems to reduce temperature of the hot water supply
- Double throttling design combines control of hot and cold water to provide sensitive response to changes in water temperature passing through mixing chamber
- Provides additional safety by restricting water flow to a trickle upon loss of cold water flow
- ASSE 1017 listed, CSA B-125 Certified



1170-M2

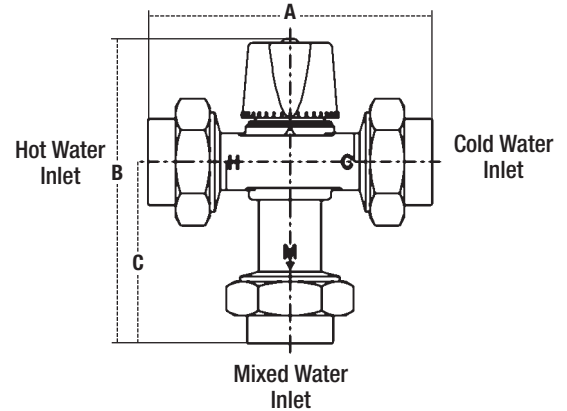

Specifications

- Bronze body
- Maximum Temperature: 200°F (93°C)
- Maximum Working Pressure: 150psi (10.3 bar)

End Connection Options

add Suffix:

UT – union thread connections

US – union solder connections

PEX – union PEX connections

CPVC – union CPVC connections

QC – Quick-Connect connections

Models

1170 - Can be set to any temperature between 90°F and 160°F (32°C and 71°C)

L1170 - Low temperature range, can be set to any temperature between 60°F and 120°F (16°C and 49°C)

For additional information, request literature ES-1170/L1170.

SIZE (DN)		MODEL	A		B		C		D	
in.	mm.		in.	mm	in.	mm	in.	mm	lbs.	kgs.
1/2	15	1170-UT-M2	4 7/8	124	5 1/16	137	3 3/16	80	1.5	.68
3/4	20		4 7/8	124	5 1/16	137	3 3/16	80	1.6	.73
1	25		5 5/16	135	5 5/8	143	3 3/8	86	1.6	.73
1/2	15	1170-US-M2	4 13/16	123	5 3/8	137	3 1/8	80	1.5	.68
3/4	20		5 5/16	135	5 5/8	143	3 3/8	86	1.6	.73
1	25		5 13/16	148	5 7/8	149	3 5/8	92	1.6	.73
1/2	15	1170-PEX-M2	5 1/4	133	5 9/16	142	3 5/16	85	1.5	.68
3/4	20		5 1/2	140	5 11/16	145	3 7/16	88	1.6	.73
1	25		5 7/8	149	5 7/8	150	3 5/8	93	1.6	.73
1/2	15	1170-CPVC-M2	4 3/4	121	5 5/16	136	3 1/16	79	1.5	.68
3/4	20		5 1/4	133	5 9/16	142	3 5/16	85	1.6	.73
1	25		5 11/16	144	5 13/16	147	3 9/16	90	1.6	.73
1/2	15	1170-QC-M2	6 5/8	168	6 1/4	159	4	102	2.17	.98
3/4	20		6 13/16	177	6 7/16	163	4 3/16	106	2.88	1.31
1	25		7 1/8	181	6 1/2	165	4 1/4	108	3.65	1.61

Series 70A (1/2")

Hot water extender tempering valves

- For residential installations, mixes cold and hot water to extend capacity of water heater, storage tanks and hot water boiler tankless heaters

Models

70A-F – Sizes 1/2" (15mm), solder connections, temperature range 120° – 160°F (49° – 71°C)

70A-T – Sizes 1/2" (15mm), NPT female connections, temperature range 120° – 160°F (49° – 71°C)

70A – Sizes 3/4" (20mm), solder connections, temperature range 120° – 160°F (49° – 71°C)

70A-T – Sizes 3/4" (20mm), NPT female connections, temperature range 120° – 160°F (49° – 71°C)

L70A-F – Sizes 1/2" (15mm), solder connections, temperature range 100° – 130°F (38° – 54°C)

L70A-T – Sizes 1/2" (15mm), NPT female connections, temperature range 100° – 130°F (38° – 54°C)

L70A – Sizes 3/4" (20mm), solder connections, temperature range 100° – 130°F (38° – 54°C)

L70A-T – Sizes 3/4" (20mm), NPT female connections, temperature range 100° – 130°F (38° – 54°C)



70A

Features

- All brass or bronze construction
- Adjustable knob for temperature control
- High capacity
- Low pressure drop

For additional information, request literature ES-70A.

MODEL	SIZE (DN)		DIMENSIONS (APPROX.)						WEIGHT					
	in.	mm	A		C		D		D1		E	lbs.	kgs.	
70A-F	1/2	15	2	50	2 3/4	70	1	25	1 3/8	41	13 1/16	21	0.68	.30
70A-T	1/2	15	2 3/4	70	2 3/4	70	1 5/8	41	1 3/8	41	13 1/16	21	1.30	.59
70A	3/4	20	2 3/4	70	2 3/4	70	1 3/8	41	1 3/8	41	13 1/16	21	0.96	.44
70A-T	3/4	20	2 3/4	70	2 3/4	70	1 3/8	41	1 3/8	41	13 1/16	21	1.20	.54
L70A-F	1/2	15	2	50	2 3/4	70	1	25	1 3/8	41	13 1/16	21	0.60	.29
L70A-T	1/2	15	2 3/4	70	2 3/4	70	1 5/8	41	1 3/8	41	13 1/16	21	1.30	.59
L70A	3/4	20	2 3/4	70	2 3/4	70	1 3/8	41	1 3/8	41	13 1/16	21	0.96	.44
L70A-T	3/4	20	2 3/4	70	2 3/4	70	1 3/8	41	1 3/8	41	13 1/16	21	1.20	.54

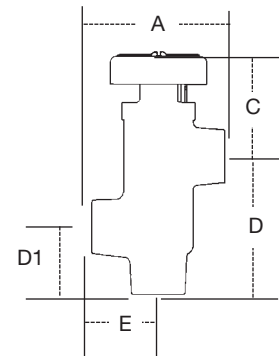

Series N170 (3/4" – 2")

Hot water extender tempering valves

- For commercial applications, mixes cold and hot water to extend capacity of water heater, storage tanks and hot water boiler tankless heaters

Specifications

- Maximum Working Pressure: 150psi (10.3 bar)
- Maximum Working Temperature: 210°F (99°C)

For additional information, request literature ES-N170.

Models

N170 – Sizes 3/4" – 2" (20 – 50mm), NPT female threaded connections, temperature range 130° – 180°F (54° – 82°C)

N170L – Sizes: 3/4" – 2" (20 – 50mm), NPT female threaded connection, temperature range 100° – 130°F (38° – 54°C)



N170

Options

HT – for high temperature hot water supply applications

Features

- Static adjustment screw seal
- All bronze construction
- Interchangeable thermostat
- High capacity
- Low pressure drop

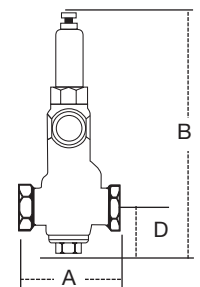

MODEL	SIZE (DN)		DIMENSIONS (APPROX.)						WEIGHT	
	in.	mm	A		B		D		lbs.	kgs.
N170-M2	3/4	20	4 1/8	105	9 1/4	235	2	50	5.2	2.4
N170-M2	1	25	4 3/4	114	9 1/4	235	2	50	5	2.3
N170-M2	1 1/4	32	6	150	9 7/8	251	2	50	8.7	3.9
N170-M2	1 1/2	40	6	150	9 7/8	251	2 1/8	54	8.3	3.8
N170-M2	2	50	6 3/8	162	9 7/8	251	2 1/8	54	9.8	4.4
N170L-M2	3/4	20	4 1/8	105	9 1/4	235	2	50	5.2	2.4
N170L-M2	1	25	4 1/2	114	9 1/4	235	2	50	5	2.3
N170L-M2	1 1/4	32	6	150	9 7/8	251	2	50	8.7	3.9
N170L-M2	1 1/2	40	6	150	9 7/8	251	2 1/8	54	8.3	3.8
N170L-M2	2	50	6 3/8	162	9 7/8	251	2 1/8	54	9.8	4.4

Series 05 (3/8" – 3/4")

Mini Water Hammer Arrestors

- Controls water hammer
- Residential and light commercial applications

Specifications

Sizes 3/8" – 3/4" (10 – 20mm).
 Maximum Working Pressure: 150psi (10.3 bar).
 Temperature Range: 33° – 180°F (0.5° – 82°C)

Standards

ASSE 1010 and IAPMO listed



Straight Models

MODEL	SIZE (DN)		CONNECTION TYPE
	in	mm	
05	3/8	10	NPT
05	1/2	15	NPT
05-CPVC	1/2	15	CPVC
05-H	3/4	20	Hose
05H-M1	3/4	20	Hose
05-S	1/2	15	Sweat
05-S	3/4	20	Sweat
05-C	5/8	16	OD Comp.

Tee Models

MODEL	SIZE (DN)		CONNECTION TYPE
	in	mm	
05-C-T	1/4	8	OD Comp.
05-C-T	3/8	10	OD Comp.
05-CXT	3/8	10	OD Comp. x Reverse Comp. Nut
05-CXT	5/8	16	OD Comp. x Reverse Comp. Nut
05-PEX-T	3/8	10	PEX
05-PEX-T	1/2	15	PEX



Features

- May be installed in concealed location with access panels
- Factory air-charged, not rechargeable
- Installed with standard pipe tee at any angle

For additional information, request literature ES-05.

Series 15 (1/2" – 2")

Water Hammer Arrestors

- Controls water hammer
- Commercial and industrial applications

Features

- 150psi (10.3 bar) operating pressure
- Copper body
- EPDM seals and O-rings
- Brass piston and cap
- Installed at any angle
- Pre-charged air chamber
- NPT solid hex brass adapter
- May be installed in concealed locations
- Factory air charged, permanently capped and epoxy sealed
- No. 15AK adapter for installing 1 1/4", 1 1/2", and 2" (32, 40, 50mm) sizes in a 1" (25mm) NPT fitting



15

Standards

ASSE 1010 and ANSI 112.26.1M approved, PDI WH201 approved and certified, Listed by IAPMO



For additional information, request literature ES-15.

CONNECTIONS		AIR PRELOAD		CROSS REF.	FIXTURES
NPT	mm	psi	kPa		
1/2"	15	60	413.7	A	1-11
3/4"	20	60	413.7	B	12-32
1"	25	60	413.7	C	33-60
1 1/4"	32	60	413.7	D	61-113
1 1/2"	40	60	413.7	E	114-154
2"	50	60	413.7	F	155-330

Series 150A (1/2" – 3/4")

Water Hammer Arrestors

- Controls water hammer

Specifications

- Maximum Working Pressure: 150psi (10.3 bar)
- Maximum Velocity: 10 fps. Maximum
- Shock Pressure: 200psi (13.8 bar)

Models

150A – Size 1/2" (15mm)
150A-HA – Size 3/4" (20mm), with hose threaded connection for washing machines



150HA

Features

- Pre-charged air chamber
- Sealed-in diaphragm
- Rechargeable

For additional information, request literature ES-150A.

Series DWB DuoClozure™ Wall Box (1/2")

Includes Watts Series 2-M2 Washing Machine shutoff Valve

- Features a decorative white faceplate which can be painted or papered to match wall deco
- Used to manually eliminate water pressure on supply hoses and prevent catastrophic water damage
- Connects to 1/2" or 2" drain piping
- Side or top water supply piping
- Supplied with water pressure test plugs



DWB

Specifications

Maximum Working Pressure: 150psi (10.3 bar)

Maximum Working Temperature: 180°F (82°C)

Features

- Decorative look and the convenience of the Watts Duo-Cloz™ valve in one complete package
- Easy to install. Complete with adjustable stud mounting brackets
- Supplied with water pressure test plugs

Models

2M2 DWB – Size 1/2" (15mm) ell solder connections for concealed piping

2M2 DWB Rough-In Kit – Contains components to rough-in and test piping and drain system

2M2 DWB-Finish Kit Contains the Series 2-M2 Duo-Cloz washing machine water shutoff valve and finish trim

For additional information, request literature PG-LR.

Series A2C-M1, IntelliFlow™ (1/2")

Automatic Washing Machine Shutoff Valve

- Automatically closes water supply valves when washing machine shuts off thus virtually eliminating water pressure on the supply hoses when machine is not in use; prevents disastrous flooding from burst hoses
- Allows hot and cold water to flow through the washing machine supply hoses to the appliance



A2C-M1

Models

A2C-M1 – Size: 1/2" (15mm), connections

- Includes A2-LS leak sensor

A2CWB-M1 – Size: 1/2" (15mm), includes recessed wall box

- Maximum Pressure: 150psi (10.3 bar)
- Maximum Temperature: 180°F (82°C)
- Includes A2-LS leak sensor

KA2-A – Size 1/2" (15mm) Installation Kit

KA2-R – Size 1/2" (15mm) Installation Kit

KA2C-BD – Size 1/2" (15mm) Installation Kit

A2-LS – Leak sensor

A2-IntelliTimer – Used in conjunction with Watts IntelliFlow in 220 VAC power applications. (Purchased separately)

Features

- Replaceable seats and internal strainer
- Ease of installation
- Includes leak sensor



A2-LS



A2-Intellitimer

For additional information, request literature F-IntelliFlow.

Series 2-M2 (1/2")

Duo-Cloz™ Washing Machine Water Shutoff Valve

- Manual valve eliminates water pressure on supply hoses and prevents catastrophic water damage
- Controls both hot and cold water simultaneously

Specifications

Maximum Pressure: 150psi (10.3 bar)
Maximum Temperature: 180°F (82°C)

Models

2-M2SC – Satin chrome finish
2T-M2, 2T-M2SC – Size 1/2" (15mm) threaded and solder copper dual adapter with two-way male connectors



2-M2

Features

- Single lever on-off
- Bronze body construction
- May be used with Model 05H and Model 150A-HA water hammer arrestors

For additional information, request literature ES-2-M2.

Series APU

SpringFit Access Panels

- Conceals plumbing, wires, cables and spa pumps
- Two sizes 9"x 9" or 15" x 15" to fit any size shape hole from 5"x 6" to 15" x 15"
- No exact measurements required
- Can be painted or wallpapered



APU

For additional information, request literature ES-SpringFit.

Series A200 (1/2")

"Flow Through" Trap Primers

- Assures delivery of water to floor drain traps to prevent evaporation of the water seal

Models

A200T – Size: 1/2" (15mm), threaded ends

A200S – Size: 1/2" (15mm), solder ends

Features

- Complete flow cycle operates valve twice
- Built-in air gap
- Bronze body
- Celcon® seat and disc



A200

For additional information, request literature ES-A200.

Series BD (1/2" x 3/4", 3/4" x 3/4")

Brass Boiler Drain Shutoffs for Water Service

- 3/4" (20mm) Hose thread connection on outlet
- Dual solder or IP connection models
- Angle and straight pattern models

Specifications

- Maximum Working Pressure: 200psi (13.8 bar) WOG
- Maximum Working Temperature: 180°F (82°C)

Models

BD1C – Size 1/2" (15mm) dual connection, solder or male IPS x 3/4" (20mm) hose thread connection, angle pattern

BD2 – Size 3/4" (20mm) male IPS x 3/4" (20mm) hose thread connection, angle pattern

BD2C – Size: 3/4" (20mm) male IPS x 3/4" (20mm) hose thread connection, angle pattern

BD3F – Size: 1/2" (15mm) female IPS x 3/4" (20mm) hose thread connection, angle pattern

BD4F – Size: 3/4" (20mm) female IPS x 3/4" (20mm) hose thread connection, angle pattern

BD5 – Size: 1/2" (15mm) straight pattern, solder or male IPS x 3/4" (20mm) hose thread connection

BD6 – Size: 3/4" (20mm) straight pattern, male IPS x 3/4" (20mm) hose thread connection



BD-1C

For additional information, request literature ES-BD.

Series BD-QT (1/2" x 3/4") (3/4" x 3/4")

Quarter-turn Brass Boiler Drain Shutoffs for Water Service

- Designed to provide the speed and convenience of quarter-turn ball valve performance for boiler drain or sill cock applications

Specifications

- Maximum Working Pressure: 200psi (13.8 bar) CWP
- Maximum Temperature: 250°F (121°C)

Features

- 3/4" (20mm) Hose thread connection on outlet
- Available 3/4" x 3/4" (20 x 20mm) MIP or Solder
- Positive shutoff
- Quarter-turn ball valve design
- Rugged aluminum Tee-handle design
- Adjustable Teflon® stem packing



3/4" BD-QT

For additional information, request literature ES-BD-QT.

Series FH, FHB (1/2" x 1/2", 3/4" x 1/2", 3/4" x 3/4")

Frost-proof Automatic Draining Wall Hydrants

- Designed to provide freeze protection for external water supply
- 3/4" (20mm) hose outlet provided with FH and FHB models
- FHB Series designed with backflow preventer to prevent contamination of the potable water supply from either backsiphonage or backpressure
- Residential and light commercial applications

Models

FH-1-M1 – Sizes: 4" – 14" (100 – 350mm), 1/2" (15mm) copper or 1/2" (15mm) male IPS inlet

FH-1-M1-PEX – Sizes: 4" – 14" (100 – 350mm), 1/2" (15mm) PEX inlet

FH-2-M1 – Sizes: 4" – 14" (100 – 350mm), 3/4" (20mm) male IPS or 1/2" (15mm) female IPS inlet

FHB-1 – For wall sizes: 4" – 14" (100 – 350mm), 1/2" (15mm) copper or 1/2" (15mm) male IPS inlet

FHB-1-PEX – Sizes: 4" – 14" (100 – 350mm), 1/2" (15mm) PEX inlet

FHB-2 – For wall sizes: 4" – 14" (100 – 350mm), 3/4" (20mm) male IPS or 1/2" (15mm) female IPS inlet

FHB-2 3/4 – For wall sizes: 12" (300mm), 3/4" (20mm) copper inlet or 3/4" (20mm) male IPS

Features

- Self-drains automatically
- Positive seat water shutoff
- ASSE 1019 approved FHB models only



FHB-1



FHB-1-PEX



FH-1-M1-PEX

For additional information, request literature ES-FH or ES-FHB.

Series HY42

Frost-proof Wall Hydrant with Backflow Preventer

- Automatic draining wall hydrant designed to blend with modern architecture
- Commercial and industrial applications

Models

HY42 – Wall thickness sizes: 2 1/2" – 18" (65 – 450mm), 1" (25mm) male IPS or 3/4" (20mm) female IPS inlet connections

Features

- Brass valve body
- Replaceable EPDM seat surface
- One piece valve plunger that controls flow and drainage
- Tamper-resistant tee key operates hydrant
- Brass pipe casing
- Chrome on brass exterior finish



HY42

HY42 Box – mounting box available

For additional information, request literature ES-HY42.

Series SC, SC8 (1/2", 3/4")

Sill Cock Faucets

- Hose bibb type faucets with tee handle or handwheel

Specifications

- Maximum Working Pressure: 125psi (8.6 bar) CWP.

Models

Tee Handle Sillcock

SC-1 – Size: 1/2" (15mm) no kink hose faucet dual inlet connection (male IPS or solder)

SC8-1 – Same as SC-1, except with vacuum breaker

SC-2 – Size: 3/4" (20mm) no kink hose solder connection x 3/4" (20mm) hose connection

SC8-2 – Same as SC-2, except with vacuum breaker

Lawn Faucet Sillcock with Cast Iron Handwheel

SC-3 – Size: 1/2" or 3/4" (15 or 20mm), solder connection x 3/4" (20mm) hose end

SC8-3 – Same as SC-3, except with vacuum breaker

SC-4 – Size: 1/2" or 3/4" (15 or 20mm), female IPS inlet connection x 3/4" (20mm) hose

SC8-4 – Same as SC-4, except with vacuum breaker

Hose Bibb Hex Shoulder Sillcock with Tee Handle

SC-5 – Size: 1/2" (15mm) male IPS or solder inlet connection x 3/4" (20mm) hose

SC8-5 – Same as SC-5, except with vacuum breaker

SC-6 – Size: 3/4" (20mm) male IPS 3/4" (20mm) hose connections

SC8-6 – Same as SC-6, except with vacuum breaker



SC-1



SC8-2



SC-3



SC8-4



SC-6



SC8-5

For additional information,
request literature ES-SC or ES-SC8.

Series SW, SS (3/8" – 3/4")

Stop and Waste Shutoff Valves

- Available as stop and waste shutoffs or for shutoff only service

Specifications

- Maximum Working Pressure: 150psi (10.3 bar) WOG
- Maximum Temperature: 80°F (27°C)

Stop and waste valves

Models

SWS – Sizes: 3/8", 1/2", 3/4" (10, 15, 20mm) solder connections

SWC – Sizes: 1/2", 3/4" (15, 20mm) compression ends

SWT – Sizes: 1/2", 3/4" (15, 20mm) NPT female connections

Stop only valves

SS – Sizes: 1/2", 3/4" (15, 20mm) solder connections

SSC – Sizes: 1/2", 3/4" (15, 20mm) compression ends

ST – Sizes: 1/2", 3/4" (15, 20mm) NPT female connections

ST-C – Sizes: 1/2", 3/4" (15, 20mm) NPT female connections with cross style handle



SWC

For additional information, request literature ES-SS or ES-SW.

Series WAMV (3/4" x 3/4", 1" x 3/4")

Brass Angle Meter Valves

- For residential or light commercial incoming water supply service

Models

WAMV – Size 3/4" flare x 3/4" female IPS (20 x 20mm) connections. Size 1" flare x 3/4" female IPS (25 x 20mm) connections

WAMV-W – Size: 3/4" flare x 3/4" female IPS (20 x 20mm) connections with waste feature

WAMV-W – Size: 1" flare x 3/4" female IPS (25 x 20mm) connections with waste feature. Maximum pressure 125psi (9 bar)

Features

- Cast brass
- With or without waste feature



WAMV

For additional information, request literature ES-WAMV.

Series WAS (1/2")

Anti-sweat Valve for Water Closets

- Mixes hot water with cold supply water to avoid condensation build up on the outside of the water closet

Specifications

- Maximum Temperature: 180°F (82°C)

Models

WAS – Size 1/2" (15mm), compression ends or IPS male connections



WAS

For additional information, request literature ES-WAS.

Series 375, 500, 750, 1000, 1250, 1500, 2000 (3/8" – 2")

Heavy Duty Mechanical Float Valves for Controlling Water Flow

- Pipe-threaded for pipe connections and straight-pipe threaded for locknut
- Machined flange for support against tank wall
- All bronze body construction
- Serrated arms for quick easy adjustment of water level
- High tensile manganese bronze long and short arms
- No jam single lever action
- Replaceable seals

Non-Threaded Outlet – High capacity valve that can be tank wall-mounted. Inlet side has a machined flange and is female NPT pipe threaded for inlet connection and male straight-pipe threaded for locknut

Threaded Outlet (500TO, 750TO) – High capacity valve with same inlet feature as standard valve, with MNPT thread on the outlet. Like the standard valves, this valve can be tank wall-mounted.

Maximum Pressure: 165psi (11.4 bar)

Maximum Temperature: 180°F (82°C)

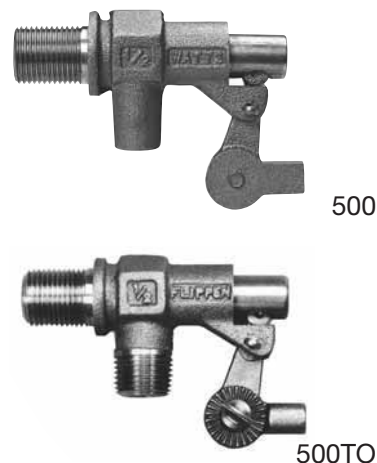

For additional information, request literature F-FV.

Heavy Duty Floats

Copper

(CX, C4 through C8, C10 and C12)

- High grade copper construction
- Firmly bonded overlapping joints (lead free solder)
- Maximum Temperature: 200°F (93°C)

Plastic

(PX, P1, P6 through P8, P12 and P16)

- Non-electrolytic, highly corrosion resistant
- Unaffected by salts and caustic fluids
- All injection molded
- Maximum Temperature: 140°F (60°C)



For additional information, request literature F-FV.

Series ST375, ST500, ST750, ST1000, ST1250, ST1500, ST2000 (3/8" – 2")

Standard Duty Mechanical Float Valves for Controlling Water Flow

- No jam single lever action
- Replaceable seals.
- Cotter pin pivot arm assembly
- Replaceable plungers
- Maximum Working Pressure: 125psi (8.6 bar)
- Maximum Temperature: 180°F (82°C)
- 3/8" – 1" (10 – 25) – Bronze body with MNPT threaded inlet and outlet
- 1 1/4" – 2" (32 – 50mm) – Bronze body with female NPT inlet-open outlet



For additional information, request literature F-FV.

Heavy Duty Cooler Valves

Bronze Body



STD-CA

Specifications

- Machined in-seat
- Buna N seals
- Adjustable brass arms
- Polyethylene float
- Maximum Working Pressure: 100psi (6.7 bar)
- Maximum Temperature: 140°F (60°C)

Model

STD-CA – 3/8" (10mm) MIP OD x 1/8" (3mm) FIP ID pipe connection

C3/8TF – 3/8" (10mm) copper tube compression inlet connection

C1/4TF-1 – 1/4" (8mm) copper tube compression inlet connection

C1/4TFAEA – 1/4" (8mm) copper tube compression inlet connection

For additional information, request literature F-FV.

Tube Fitting Mini Cooler Valves

Brass Body



M1/4" FSS

- Machined in-seat
- Buna-N seals
- Adjustable brass arms
- Polyethylene float

Models

M1/4TF – 1/4" (8mm) copper tube compression inlet connection

M1/4TFSS – 1/4" (8mm) copper tube compression inlet connection

For additional information, request literature F-FV.

RL600

Automatic Livestock Watering Kits

- 1 1/4" (32mm) MNPT threaded with 1/2" (15mm) FNPT threaded inlet.
- Consists of RL600V nozzle and arm assembly, RL600SC stem and chain assembly and P6 float. For use on Rubbermaid® brand livestock tanks.
- RL600 plus universal tank adapter (No. UA600) for use in all livestock tanks.

Features

- High capacity
- Easy installations
- Animal proof
- Resist freezing
- Durable



RL600

For additional information, request literature F-FV.

Series 3000 (1/2" – 4")

Dielectric Unions/Fittings

- Protects against destructive effect of galvanic and stray current corrosion
- For residential, commercial and industrial applications

Specifications

- Supplied with GA gaskets suitable for water, air, oil, natural gas, gasoline, propane, kerosene, mineral oil and alkalies. For other applications, consult factory
- Dielectric Unions are rated to 180°F (82°C) at 250psi (17.2 bar) conforming to ANSI B16.39. Pipe threads are in accordance with ANSI B2.1
- Dielectric Flange Fittings are rated at 175psi (12.1 bar) conforming to B16.42 (iron), B16.24 (bronze)

Standards

Unions meet the requirements of ANSI B16.39, including hydrostatic strength, tensile strength and air pressure testing.

Flange fittings conform to B16.42 (iron), B16.24 (bronze).

All pipe threads are in accordance with ANSI B2.1 and solder joints meet national plumbing standards.

- Gray Iron. ASTM A48-83
- Malleable Iron Parts ASTM A197-79
- Steel Parts ASTM A108
- Brass Parts. ASTM B16
- Bronze Parts. ASTM B584
- Zinc Parts. ASTM B633-85
- Insulators Watts #1425
- Standard Gasket A. Buna

Models

- 3001A** – Sizes 1/2" – 2" (15 – 50mm), female iron pipe thread to solder connection
- 3002** – Sizes 1/2" x 3/8", 3/4" x 1/2", 1" x 3/4" (15 x 10, 20 x 15, 25 x 20mm), female iron pipe thread to reduced solder connection.
- 3003** – Sizes 1/2" – 2" (15 – 50mm), female iron pipe thread to female brass pipe
- 3004** – Sizes 1/2" – 2" (15 – 50mm), female iron pipe thread to female iron pipe thread (galvanized)
- 3005A** – Sizes 1/2" – 3/4" (15 – 20mm), male iron pipe thread to solder connection
- 3006** – Sizes 1/2" – 2" (15 – 50mm), female iron pipe thread to female iron pipe thread (black)
- 3007** – Sizes 1/2" x 3/8" – 3/4" x 1/2" (15 x 10mm – 20 x 15mm), male iron pipe thread to female solder connection
- 3008** – Sizes 1/2" – 1" (15 – 25mm), female brass pipe thread to female solder connection.

Flanged Fittings

- 3100** – Sizes 2" – 4" (50 – 100mm), iron pipe thread to copper solder joint
- 3110** – Sizes 2 1/2" – 4" (65 – 100mm), solder copper fitting, bronze (125 class flange)
- 3200** – Sizes 2" – 4" (50 – 100mm), iron pipe thread to iron pipe thread

For additional information, request literature F-3000.



3002



3100

Optional Gasket

add Suffix:

GB – EPDM gasket for use in steam or hot water applications up to 300°F (149°C) at 50psi (3.4 bar)

Features

- Meets federal specifications for both tensile strength and thread end connections
- All dielectric unions individually factory certified to withstand a minimum of 600 volts on a dry line with no flashover
- Watts dielectric fittings/unions are designed and manufactured to the highest quality standards

Bolt Insulators – for insulating flange bolts – Installation Kit

BOLT SIZE		QTY./CARTON	WEIGHT	
<i>in.</i>	<i>mm</i>		<i>lbs.</i>	<i>kgs.</i>
1/2	15	100	1.75	.8
5/8	16	100	1.75	.8
3/4	20	100	2	.9
7/8	22	100	2	.9

MODEL	SIZE (DN)		DIMENSIONS (APPROX.)				WEIGHT	
	in.	mm	A		B		oz.	gm.
			in.	mm	in.	mm		
3001A	1/2	15	1 1/2	32	1 7/8	48	6.0	170
3001A	3/4	20	1 5/8	41	2 1/8	54	6.7	190
3001A	1	25	1 7/8	48	2 1/2	64	9.3	264
3001A	1 1/4	32	2 1/4	57	3	76	13.3	377
3001A	1 1/2	40	2 3/4	70	3	76	13.3	377
3001A	2	50	3 1/2	89	3	76	34.7	984
3002	1/2 x 3/8	15x10	1 1/2	38	1 7/8	48	6.7	190
3002	3/4 x 1/2	20x15	1 5/8	41	1 7/8	48	6.7	190
3002	1 x 3/4	25x20	1 7/8	48	2 1/2	64	10.7	303
3003	1/2	15	1 5/8	41	2 1/4	57	6.7	190
3003	3/4	20	1 7/8	48	2 1/4	57	14.7	417
3003	1	25	2 1/4	57	2 1/2	64	20.0	567
3003	1 1/4	32	2 3/4	70	2 3/4	70	26.7	757
3003	1 1/2	40	3 1/2	89	2 3/4	70	48.0	1366
3003	2	50	4 1/8	105	3 1/8	79	69.3	1965
3004	1/2	15	1 5/8	41	2 1/4	57	6.7	190
3004	3/4	20	1 7/8	48	2 1/4	57	14.7	417
3004	1	25	2 1/4	57	2 1/2	64	20.0	567
3004	1 1/4	32	2 3/4	70	2 3/4	70	26.7	757
3004	1 1/2	40	3 1/2	89	2 3/4	70	45.0	1276
3004	2	50	4 1/8	105	3 1/8	79	8.7	247
3005A	1/2	15	1 1/2	38	2 5/8	67	8.6	244
3005A	3/4	20	1 5/8	41	3	76	12.6	377
3006	1/2	15	1 5/8	41	2 1/4	57	6.7	190
3006	3/4	20	1 7/8	48	2 1/4	57	14.7	417
3006	1	25	2 1/4	58	2 1/2	64	20.0	567
3006	1 1/4	32	2 3/4	70	2 3/4	70	26.7	757
3006	1 1/2	40	3 1/2	89	2 3/4	70	45.3	1284
3006	2	50	4 1/8	105	3 1/8	79	64.0	1814
3007	1/2 x 3/8	15x10	1 1/2	38	2 5/8	67	6.7	190
3007	3/4 x 1/2	20x15	1 5/8	41	3	76	6.7	190
3008	1/2	15	1 1/2	38	1 7/8	48	6.7	190
3008	3/4	20	1 5/8	41	2 1/8	54	10.7	303
3008	1	25	1 7/8	48	2 1/2	64	14.7	417

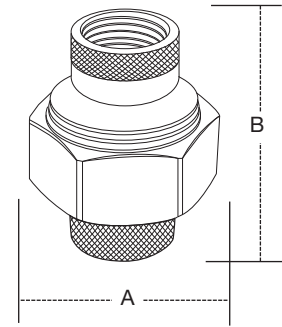

FLANGED FITTINGS

3100	2	50	5 1/8	130	3 1/4	83	128	3629
3100	2 1/2	65	5 7/8	149	3 1/2	89	192	5443
3100	3	80	6 3/4	171	3 3/4	95	224	6350
3100	4	100	9 1/8	232	4 3/8	111	480	13608
3110	2 1/2	65	5 7/8	149	3 1/2	89	192	5443
3110	3	80	6 3/4	171	3 3/4	95	240	6804
3110	4	100	9 1/8	232	4 3/8	111	288	8165
3110LF	2 1/2	65	5 7/8	149	3 1/2	89	96	44
3110LF	3	80	6 3/4	171	3 1/2	89	120	54
3110LF	4	100	9 1/8	232	4 3/8	111	144	65
3200	2	50	5 1/8	130	2 1/8	54	128	3629
3200	2 1/2	65	5 7/8	149	2 3/4	70	192	5443
3200	3	80	6 3/4	171	2 3/4	70	240	6804
3200	4	100	9 1/8	232	3	76	496	14062

Series FS-CDC-S (3/8" – 1/2")

FloodSafe™ Braided Stainless Steel Dishwasher Connectors

- FloodSafe™ shutoff device protects against catastrophic water damage
- Patented design
- Requires no power source
- Supplied with elbow fittings
- PVC tubing jacketed with braided stainless steel
- Superior resistance to chlorinated water
- Available lengths: 48", 60", 72"

Models

FS-CDC-S-CE – Size: 3/8" (10mm) brass nut compression end fitting x 3/8" (10mm) compression end fitting with a brass male iron pipe thread elbow attached to the compression end fitting

FS-CDC-S-FE – Size: 1/2" (15mm) brass nut female iron pipe (FIP) thread connector x 3/8" (10mm) compression end fitting with a brass male iron pipe thread elbow attached to the compression end fitting



FS-CDC-S-FE

Maximum Pressure: 125psi (8.6 bar)
Maximum Temperature: 180°F (82°C)

Note: National residential plumbing codes reference the maximum operating temperature as 140°F (60°C). Plumbing fixtures are designed to ANSI-ASME A112 18.1 at 125psi (8.6 bar). For other applications requiring higher operating temperatures or pressures, please contact Watts Regulator Technical Service at (978) 689-6130.

For additional information, request literature ES-FS-CDC-S.

Series FS-CFC-S (3/8" – 1/2")

FloodSafe™ Braided Stainless Steel Faucet Connectors

- FloodSafe™ shutoff device protects against catastrophic water damage
- Patented design
- Requires no power source
- PVC tubing jacketed with braided stainless steel
- Superior resistance to vibration and bursting
- Available lengths: 12", 16", 20"

Models

FS-CFC-S-CC – Size: 3/8" x 3/8" (10 x 10mm) brass nut compression end fittings

FS-CFC-S-CF – Size: 1/2" (15mm) brass compression end fitting x 1/2" (15mm) brass female iron pipe (FIP) thread fitting

FS-CFC-S-CF – Size: 3/8" (10mm) brass compression end fitting x 1/2" (15mm) brass FIP thread fitting

FS-CFC-S-CF – Size: 7/16" (11mm) brass compression end fitting x 1/2" (15mm) brass FIP thread fitting

FS-CFC-S-FF – Size: 1/2" x 1/2" (15 x 15mm) brass FIP thread fittings

FS-CFC-S-TF – Size: 1/2" (15mm) brass fine thread female end x 1/2" (15mm) brass FIP thread fitting

FS-CFC-S-TF – Size: 3/8" (10mm) brass fine thread female end x 1/2" (15mm) brass FIP thread fitting



FS-CFC-S-CC

Delta Style Faucet Connector:

FS-CFC-S-CO – Size: 3/8" (10mm) brass compression end fitting x 3/8" (10mm) brass OD compression end fitting

Maximum Pressure: 125psi (8.6 bar)
Maximum Temperature: 180°F (82°C)

All hoses are NSF61 approved for safer drinking water.

Note: National residential plumbing codes reference the maximum operating temperature as 140°F (60°C). Plumbing fixtures are designed to ANSI-ASME A112 18.1 at 125psi (8.6 bar). For other applications requiring higher operating temperatures or pressures, please contact Watts Regulator Technical Service at (978) 689-6130.

For additional information, request literature ES-FS-CFC-S.

Series FS-CIC-S (1/4")

FloodSafe™ Braided Stainless Steel Ice Maker Connectors

- FloodSafe™ shutoff device protects against catastrophic water damage
- Patented design
- Requires no power source
- PVC tubing jacketed with braided stainless steel
- Available lengths: 6', 10', 20'

Specifications

- Maximum Working Pressure: 125psi (8.6 bar)
- Maximum Working Temperature: 140°F (60°C)

Models

FS-CIC-S – Size: 1/4" x 1/4" (8 x 8mm) brass compression end fittings



FS-CIC-S

Note: National residential plumbing codes reference the maximum operating temperature as 140°F (60°C). Plumbing fixtures are designed to ANSI-ASME A112 18.1 at 125psi (8.6 bar). For other applications requiring higher operating temperatures or pressures, please contact Watts Regulator Technical Service at (978) 689-6130.

For additional information, request literature ES-FS-CIC-S.

Series FS-CTC-S (3/8" – 1/2")

FloodSafe™ Braided Stainless Steel Toilet Connectors

- FloodSafe™ shutoff device protects against catastrophic water damage
- Patented design
- Requires no power source
- Superior hook-up for toilet water supply
- Resists damage from extreme pressure surges
- PVC tubing jacketed with braided stainless steel
- Available lengths: 6", 9", 12"

Specifications

- Maximum Working Pressure: 125psi (8.6 bar)
- Maximum Working Temperature 180°F (82°C)

Models

FS-CTC-S-CB – Size: 3/8" (10mm) brass compression end fitting x 7/8" (22mm) ballcock end fitting

FS-CTC-S-CB – Size: 7/16" (11mm) brass compression end fitting x 7/8" (22mm) ballcock end fitting

FS-CTC-S-CB – Size: 1/2" (15mm) brass compression end fitting x 7/8" (22mm) ballcock end fitting

FS-CTC-S-FB – Size: 1/2" (15mm) brass female iron pipe (FIP) thread fitting x 7/8" (22mm) ballcock end fitting

FS-CTC-S-TB – Size: 3/8" (10mm) brass fine thread FIP end x 7/8" (22mm) ballcock end fitting

FS-CTC-S-TB – Size: 1/2" (15mm) brass fine thread FIP end x 7/8" (22mm) ballcock end fitting



FS-CTC-S-FB

Note: A minimum flow rate of 2.5 gallons per minute at the supply connection is required for proper shutoff operation. (Typically 30psi (206.9 kPa) supply pressure meets this requirement.) Performance is accurate to the 80psi (551.6 kPa) Maximum system pressure as required by national plumbing codes.

Note: National residential plumbing codes reference the maximum operating temperature as 140°F (60°C). Plumbing fixtures are designed to ANSI-ASME A112 18.1 at 125psi (8.6 bar). For other applications requiring higher operating temperatures or pressures, please contact Watts Regulator Technical Service at (978) 689-6130.

For additional information, request literature ES-FS-CTC-S.

Series FS-CWM-S (3/4" x 3/4")

FloodSafe™ Braided Stainless Steel Washing Machine Connectors

- FloodSafe™ shutoff device protects against catastrophic water damage
- Patented design
- Requires no power source
- Full flow capacity
- Superior resistance to the destructive effects of vibration/extreme pressure surges caused by washing machine solenoid valves
- PVC tubing jacketed with braided stainless steel
- Available lengths: 48", 60", 72"

Specifications

- Maximum Working Pressure: 125psi (8.6 bar)
- Maximum Working Temperature: 180°F (82°C)

Models

FS-CWM-S-HH – Size 3/4" x 3/4" (20 x 20mm) female hose bibb connections



FS-CWM-S-HH

Note: A minimum flow rate of 2.5 gallons per minute at the supply connection is required for proper shutoff operation. (Typically 30psi (206.9 kPa) supply pressure meets this requirement.) Performance is accurate to the 80psi (551.6 kPa) Maximum system pressure as required by national plumbing codes.

Note: National residential plumbing codes reference the maximum operating temperature as 140°F (60°C). Plumbing fixtures are designed to ANSI-ASME A112 18.1 at 125psi (8.6 bar). For other applications requiring higher operating temperatures or pressures, please contact Watts Regulator Technical Service at (978) 689-6130.

For additional information, request literature ES-FS-CWM-S.

Series CDC-S (3/8" – 3/4")

Braided Stainless Steel Water Supply Connectors for Dishwashers

- Supplied with elbow fittings
- PVC tubing jacketed with braided stainless steel
- Superior resistance to chlorinated water
- Available lengths: 48", 60", 72"

Models

CDC-S-CE – Size: 3/8" (10mm) brass nut compression end fitting x 3/8" (10mm) compression end fitting with a brass male iron pipe thread elbow attached to the compression end fitting

CDC-S-FE – Size: 1/2" (15mm) brass nut female iron pipe (FIP) thread connector x 3/8" (10mm) compression end fitting with a brass male iron pipe thread elbow attached to the compression end fitting



CDC-S-FE

Maximum Pressure: 125psi (8.6 bar)
Maximum Temperature: 180°F (82°C)

Note: National residential plumbing codes reference the maximum operating temperature as 140°F (60°C). Plumbing fixtures are designed to ANSI-ASME A112 18.1 at 125psi (8.6 bar). For other applications requiring higher operating temperatures or pressures, please contact Watts Regulator Technical Service at (978) 689-6130.

For additional information, request literature ES-CDC-S.

Series CFC-S (3/8" – 1/2")

Flexible, Braided Stainless Steel Water Supply Connectors for Faucets

- PVC tubing jacketed with braided stainless steel
- Excellent for difficult installations involving misalignment of piping or cramped locations
- Superior resistance to vibration and bursting
- Available lengths: 12", 16", 20", 24", 30", 36", 48", 60", 72"

Models

CFC-S-CC – Size: 3/8" x 3/8" (10 x 10mm) brass nut compression end fittings

CFC-S-FF – Size: 1/2" x 1/2" (15 x 15mm) brass FIP thread fittings

CFC-S-CF – Size: 1/2" (15mm) brass compression end fitting x 1/2" (15mm) brass female iron pipe (FIP) thread fitting

CFC-S-TF – Size: 1/2" (15mm) brass fine thread female end x 1/2" (15mm) brass FIP thread fitting

CFC-S-CF – Size: 3/8" (10mm) brass compression end fitting x 1/2" (15mm) brass FIP thread fitting

CFC-S-TF – Size: 3/8" (10mm) brass fine thread female end x 1/2" (15mm) brass FIP thread fitting

CFC-S-CF – Size: 7/16" (11mm) brass compression end fitting x 1/2" (15mm) brass FIP thread fitting



CFC-S-CC

Delta Style Faucet Connector:

CFC-S-CO – Size: 3/8" (10mm) brass compression end fitting x 3/8" (10mm) brass OD compression end fitting

Maximum Pressure: 125psi (8.6 bar)
Maximum Temperature: 180°F (82°C)

All hoses are NSF61 approved for safer drinking water.

Note: National residential plumbing codes reference the maximum operating temperature as 140°F (60°C). Plumbing fixtures are designed to ANSI-ASME A112 18.1 at 125psi (8.6 bar). For other applications requiring higher operating temperatures or pressures, please contact Watts Regulator Technical Service at (978) 689-6130.

For additional information, request literature ES-CFC-S.

Series CFC-P (3/8" – 1/2")

Flexible, Reinforced PVC Water Supply Connectors for Faucets

- PVC tubing jacketed with braided nylon and an outer protective layer of PVC
- Resistance to the effects of vibration and bursting from extreme pressure surges
- Available lengths: 12", 16", 20", 24", 30", 36", 48", 60", 72"

Specifications

- Maximum Working Pressure: 125psi (8.6 bar)
- Maximum Temperature: 140°F (60°C)

Models

CFC-P-CC – Size: 3/8" x 3/8" (10 x 10mm) brass nut compression end fittings

CFC-P-CF – Size: 1/2" (15mm) brass compression end fitting x 1/2" (15mm) brass FIP thread fitting

CFC-P-CF – Size: 7/16" (11mm) brass compression end fitting x 1/2" (15mm) brass FIP thread fitting

CFC-P-CF – Size: 3/8" (10mm) brass compression end fitting x 1/2" (15mm) brass female iron pipe (FIP) thread fitting

CFC-P-FF – Size: 1/2" x 1/2" (15 x 15mm) brass FIP thread fittings

CFC-P-TF – Size: 1/2" (15mm) brass fine thread FIP fitting x 1/2" (15mm) brass FIP thread fitting



CFC-P-CF

CFC-P-TF – Size: 3/8" (10mm) brass fine thread FIP fitting x 1/2" (15mm) brass FIP thread fitting

Note: National residential plumbing codes reference the maximum operating temperature as 140°F (60°C). Plumbing fixtures are designed to ANSI-ASME A112 18.1 at 125psi (8.6 bar). For other applications requiring higher operating temperatures or pressures, please contact Watts Regulator Technical Service at (978) 689-6130.

For additional information, request literature ES-CFC-P.

Model CIC-P (1/4")

Flexible, Reinforced PVC Water Supply Connectors for Ice Makers

- PVC tubing jacketed with braided nylon and an outer protective layer of PVC
- Available lengths: 6', 10', 20'

Specifications

- Maximum Working Pressure: 125psi (8.6 bar)
- Maximum Working Temperature: 140°F (60°C)

Models

CIC-P – Size: 1/4" x 1/4" (8 x 8mm) brass compression end fittings



CIC-P

Note: National residential plumbing codes reference the maximum operating temperature as 140°F (60°C). Plumbing fixtures are designed to ANSI-ASME A112 18.1 at 125psi (8.6 bar). For other applications requiring higher operating temperatures or pressures, please contact Watts Regulator Technical Service at (978) 689-6130.

For additional information, request literature ES-CIC-P.

Series CTC-S (3/8" – 1/2")

Flexible, Braided Stainless Steel Water Supply Connectors for Toilets

- Superior hook-up for toilet water supply
- Resists damage from extreme pressure surges
- PVC tubing jacketed with braided stainless steel
- Available lengths: 6", 9", 12", 16", 20"

Specifications

- Maximum Working Pressure: 125psi (8.6 bar)
- Maximum Working Temperature 180°F (82°C)

Models

CTC-S-CB – Size: 3/8" (10mm) brass compression end fitting x 7/8" (22mm) ballcock end fitting

CTC-S-CB – Size: 7/16" (11mm) brass compression end fitting x 7/8" (22mm) ballcock end fitting

CTC-S-CB – Size: 1/2" (15mm) brass compression end fitting x 7/8" (22mm) ballcock end fitting

CTC-S-FB – Size: 1/2" (15mm) brass female iron pipe (FIP) thread fitting x 7/8" (22mm) ballcock end fitting

CTC-S-TB – Size: 3/8" (10mm) brass fine thread FIP end x 7/8" (22mm) ballcock end fitting

CTC-S-TB – Size: 1/2" (15mm) brass fine thread FIP end x 7/8" (22mm) ballcock end fitting



CTC-S-FB

Note: National residential plumbing codes reference the maximum operating temperature as 140°F (60°C). Plumbing fixtures are designed to ANSI-ASME A112 18.1 at 125psi (8.6 bar). For other applications requiring higher operating temperatures or pressures, please contact Watts Regulator Technical Service at (978) 689-6130.

For additional information, request literature ES-CTC-S.

Series CTC-P (3/8" – 7/8")

Flexible, Reinforced PVC Water Supply Connectors for Toilets

- Efficient hook-up for water supply to toilet
- PVC tubing jacketed with braided nylon and an outer protective layer of PVC
- Available lengths: 6", 9", 12", 16", 20"

Specifications

- Maximum Working Pressure: 125psi (8.6 bar)
- Maximum Working Temperature: 140°F (60°C)

Models

CTC-P-CB – Size: 3/8" (10mm) brass compression end fitting x 7/8" (22mm) ballcock end fitting

CTC-P-CB – Size: 7/16" (11mm) brass compression end fitting x 7/8" (22mm) ballcock end fitting

CTC-P-CB – Size: 1/2" (15mm) brass compression end fitting x 7/8" (22mm) ballcock end fitting

CTC-P-TB – Size: 3/8" (10mm) brass fine thread female iron pipe (FIP) fitting x 7/8" (22mm) ballcock end fitting

CTC-P-TB – Size: 1/2" (15mm) brass fine thread FIP fitting x 7/8" (22mm) ballcock end fitting

CTC-P-FB – Size: 1/2" (15mm) brass FIP thread fitting x 7/8" (22mm) ballcock end fitting



CTC-P-CB

Note: National residential plumbing codes reference the maximum operating temperature as 140°F (60°C). Plumbing fixtures are designed to ANSI-ASME A112 18.1 at 125psi (8.6 bar). For other applications requiring higher operating temperatures or pressures, please contact Watts Regulator Technical Service at (978) 689-6130.

For additional information, request literature ES-CTC-P.

Series CWH-S (5/8" – 7/8")

Flexible, Braided Stainless Steel Water Heater Connectors

- For connecting water heaters to the water supply
- Protects against the destructive effects of system pressure surges
- PVC tubing jacketed with braided stainless steel
- Available lengths: 12", 15", 18", 24", 36", 48", 60"

Specifications

- Maximum Working Pressure: 150psi (10.3 bar)
- Maximum Working Temperature: 180°F (82°C)
- All hoses are NSF 61 approved for safer drinking water

Models

CWH-S-FF-L – Size: 3/4" x 3/4" (20x20mm), brass female iron pipe (FIP) threaded ends

CWH-S-AF-L – Size: 5/8" (16mm) compression end fitting x 3/4" (20mm) brass FIP threaded fitting

CWH-S-AF-L – Size: 7/8" (22mm) compression end fitting x 3/4" (20mm) brass FIP threaded fitting

CWH-S-AA-L – Size: 7/8" x 7/8" (22 x 22mm) compression end fittings

CWH-S-FM-L – Size: 3/4" (20mm) brass FIP thread fitting x 3/4" (20mm) brass male iron pipe threaded fitting

CWHS-AM-L – Size: 7/8" (22mm) compression end fitting x 3/4" (20mm) brass male iron pipe threaded fitting

Note: National residential plumbing codes reference the maximum operating temperature as 140°F (60°C). Plumbing fixtures are designed to ANSI-ASME A112 18.1 at 125psi (8.6 bar). For other applications requiring higher operating temperatures or pressures, please contact Watts Regulator Technical Service at (978) 689-6130.

For additional information, request literature ES-CWH-S.



CWH-S-FF-L

Series CWM-S (3/4" x 3/4")

Flexible, Braided Stainless Steel Washing Machine Water Supply Connectors

- Full flow capacity
- Superior resistance to the destructive effects of vibration/extreme pressure surges caused by washing machine solenoid valves
- PVC tubing jacketed with braided stainless steel
- Available lengths: 48", 60", 72"

Specifications

- Maximum Working Pressure: 125psi (8.6 bar)
- Maximum Working Temperature: 180°F (82°C)

Models

CWM-S-HH – Size 3/4" x 3/4" (20 x 20mm) female hose bibb connections

CWM-S-HL – Size 3/4" x 3/4" (20 x 20mm) female hose bibb connections with one connection secured to a 90° elbow

Note: National residential plumbing codes reference the maximum operating temperature as 140°F (60°C). Plumbing fixtures are designed to ANSI-ASME A112 18.1 at 125psi (8.6 bar). For other applications requiring higher operating temperatures or pressures, please contact Watts Regulator Technical Service at (978) 689-6130.

For additional information, request literature ES-CWM-S.



CWM-S-HL

Series DPG1 (2" – 4")

Bottom Entry Pressure Gauges

- Available in dial sizes 2", 2½", 3", 4"
- ¼" (8mm) NPT connection
- Working temperature: -4°F to 176°F (-20°C to 80°C)



DPG1-2

For additional information,
request literature ES-DPG-1.

MODEL	DIAL SIZE	SCALE	
DPG1-2	2"	0 – 15psi	0 – 103 kPa
DPG1-2	2"	0 – 30psi	0 – 207 kPa
DPG1-2	2"	0 – 60psi	0 – 413 kPa
DPG1-2	2"	0 – 100psi	0 – 689 kPa
DPG1-2	2"	0 – 160psi	0 – 1103 kPa
DPG1-2	2"	0 – 200psi	0 – 1379 kPa
DPG1-2	2"	0 – 300psi	0 – 2069 kPa
DPG1-2½	2½"	0 – 15psi	0 – 103 kPa
DPG1-2½	2½"	0 – 30psi	0 – 207 kPa
DPG1-2½	2½"	0 – 60psi	0 – 413 kPa
DPG1-2½	2½"	0 – 100psi	0 – 689 kPa
DPG1-2½	2½"	0 – 160psi	0 – 1103 kPa
DPG1-2½	2½"	0 – 200psi	0 – 1379 kPa
DPG1-2½	2½"	0 – 300psi	0 – 2069 kPa
DPG1-3	3"	0 – 15psi	0 – 103 kPa
DPG1-3	3"	0 – 30psi	0 – 207 kPa
DPG1-3	3"	0 – 60psi	0 – 413 kPa
DPG1-3	3"	0 – 100psi	0 – 689 kPa
DPG1-3	3"	0 – 160psi	0 – 1103 kPa
DPG1-3	3"	0 – 200psi	0 – 1379 kPa
DPG1-3	3"	0 – 300psi	0 – 2069 kPa
DPG1-4	4"	0 – 15psi	0 – 103 kPa
DPG1-4	4"	0 – 30psi	0 – 207 kPa
DPG1-4	4"	0 – 60psi	0 – 413 kPa
DPG1-4	4"	0 – 100psi	0 – 689 kPa
DPG1-4	4"	0 – 160psi	0 – 1103 kPa
DPG1-4	4"	0 – 200psi	0 – 1379 kPa
DPG1-4	4"	0 – 300psi	0 – 2069 kPa
DPG1-4	4"	0 – 600psi	0 – 4137 kPa
DPG1-4	4"	0 – 1000psi	0 – 6895 kPa

Series DPG3 (1½" – 3")

Center Back Entry Pressure Gauges

- Available in dial sizes 1½", 2", 2½", 3"
- ⅜", ¼" (3, 8mm) NPT connection
- Working temperature -4°F to 176°F (-20°C to 80°C)



DPG3

For additional information,
request literature ES-DPG-3.

MODEL	DIAL SIZE	SCALE	
DPG3-1½	1½"	0 – 60psi	0 – 413 kPa
DPG3-1½	1½"	0 – 160psi	0 – 1103 kPa
DPG3-2	2"	0 – 15psi	0 – 103 kPa
DPG3-2	2"	0 – 30psi	0 – 207 kPa
DPG3-2	2"	0 – 60psi	0 – 413 kPa
DPG3-2	2"	0 – 100psi	0 – 689 kPa
DPG3-2	2"	0 – 160psi	0 – 1103 kPa
DPG3-2	2"	0 – 200psi	0 – 1379 kPa
DPG3-2	2"	0 – 300psi	0 – 2069 kPa
DPG3-2½	2½"	0 – 15psi	0 – 103 kPa
DPG3-2½	2½"	0 – 30psi	0 – 207 kPa
DPG3-2½	2½"	0 – 60psi	0 – 413 kPa
DPG3-2½	2½"	0 – 100psi	0 – 689 kPa
DPG3-2½	2½"	0 – 160psi	0 – 1103 kPa
DPG3-2½	2½"	0 – 200psi	0 – 1379 kPa
DPG3-2½	2½"	0 – 300psi	0 – 2069 kPa
DPG3-3	3"	0 – 15psi	0 – 103 kPa
DPG3-3	3"	0 – 30psi	0 – 207 kPa
DPG3-3	3"	0 – 60psi	0 – 413 kPa
DPG3-3	3"	0 – 100psi	0 – 689 kPa
DPG3-3	3"	0 – 160psi	0 – 1103 kPa
DPG3-3	3"	0 – 200psi	0 – 1379 kPa
DPG3-3	3"	0 – 300psi	0 – 2069 kPa

Series DPG5 (2" – 3")

Top Entry Pressure Gauges

- Available in dial sizes 2", 2½", 3"
- ⅛", ¼" (3, 8mm) NPT connection
- Working temperature -4°F to 176°F (-20°C to 80°C)



DPG5

MODEL	DIAL SIZE	SCALE
DPG5-2 (⅛" connection)	2"	0 – 160psi 0 – 11 bar
DPG5-2	2"	0 – 15psi 0 – 103 kPa
DPG5-2	2"	0 – 30psi 0 – 207 kPa
DPG5-2	2"	0 – 60psi 0 – 413 kPa
DPG5-2	2"	0 – 100psi 0 – 689 kPa
DPG5-2	2"	0 – 160psi 0 – 1103 kPa
DPG5-2	2"	0 – 200psi 0 – 1379 kPa
DPG5-2	2"	0 – 300psi 0 – 2069 kPa
DPG5-2½"	2½"	0 – 15psi 0 – 103 kPa
DPG5-2½"	2½"	0 – 30psi 0 – 207 kPa
DPG5-2½"	2½"	0 – 60psi 0 – 413 kPa
DPG5-2½"	2½"	0 – 100psi 0 – 689 kPa
DPG5-2½"	2½"	0 – 160psi 0 – 1103 kPa
DPG5-2½"	2½"	0 – 200psi 0 – 1379 kPa
DPG5-2½"	2½"	0 – 300psi 0 – 2069 kPa
DPG5-3	3"	0 – 15psi 0 – 103 kPa
DPG5-3	3"	0 – 30psi 0 – 207 kPa
DPG5-3	3"	0 – 60psi 0 – 413 kPa
DPG5-3	3"	0 – 100psi 0 – 689 kPa
DPG5-3	3"	0 – 160psi 0 – 1103 kPa
DPG5-3	3"	0 – 200psi 0 – 1379 kPa
DPG5-3	3"	0 – 300psi 0 – 2069 kPa

For additional information, request literature ES-DPG-5.

Series DPTG1 and DPTG3 (2½" – 3")

Combined Temperature and Pressure Gauges

Models

- **DPTG1** bottom entry 3" dial size
- **DPTG3** center back entry, 2½" or 3" dial size
- **DPTG3A** center back entry with extended temperature element
- **DPTG3L** center back entry with extended mounting nut
- ½" (15mm) NPT connection
- Working temperature 40°F to 250°F (4.4°C to 121°C)

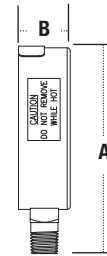
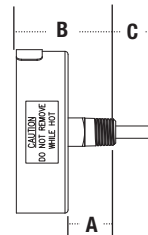

DPTG3

For additional information, request literature ES-DPTG-1 or ES-DPTG-3.

MODEL	DIAL SIZE	SIZE		SCALE	TEMPERATURE RANGE		INCLUDES VR RETAINING VALVE	DIMENSIONS							
		in.	mm		°F	°C		A		B		C			
DPTG1-3	3"	½"	15	0 – 50psi 0 – 345kPa	32 – 248	0 – 120	N	4	101	1	25	–	–	–	–
DPTG1-3	3"	½"	15	0 – 75psi 0 – 517kPa	32 – 248	0 – 120	N	4	101	1	25	–	–	–	–
DPTG1-3	3"	½"	15	0 – 200psi 0 – 689 kPa	32 – 248	0 – 120	N	4	101	1	25	–	–	–	–
DPTG3-2½"	2½"	½"	15	0 – 50psi 0 – 340 kPa	60 – 320	16 – 160	Y	1	25	1½/16	49	7/8	23	–	–
DPTG3-2½"	2½"	½"	15	0 – 75psi 0 – 517 kPa	60 – 320	16 – 160	Y	1	25	1½/16	49	7/8	23	–	–
DPTG3-2½"	2½"	½"	15	0 – 200psi 0 – 1379 kPa	60 – 320	16 – 160	Y	1	25	1½/16	49	7/8	23	–	–
DPTG3-2½"	2½"	¼"	8	0 – 75psi 0 – 517 kPa	60 – 320	16 – 160	N	1	25	1½/16	49	7/8	23	–	–
DPTG3-3	3"	½"	15	0 – 50psi 0 – 340 kPa	60 – 320	16 – 160	Y	1	25	1½/16	49	7/8	23	–	–
DPTG3-3	3"	½"	15	0 – 75psi 0 – 517 kPa	60 – 320	16 – 160	Y	1	25	1½/16	49	7/8	23	–	–
DPTG3-3	3"	½"	15	0 – 200psi 0 – 1379 kPa	60 – 320	16 – 160	Y	1	25	1½/16	49	7/8	23	–	–
DPTG3A-2½"	2½"	¼"	8	0 – 75psi 0 – 517 kPa	60 – 320	16 – 160	N	1	25	1½/16	49	2	51	–	–
DPTG3A-3	3"	¼"	8	0 – 75psi 0 – 517 kPa	60 – 320	16 – 160	N	1	25	1½/16	49	2	51	–	–
DPTG3L-2½"	2½"	¼"	8	0 – 75psi 0 – 517 kPa	60 – 320	16 – 160	N	2	51	3½/16	100	1	25	–	–
DPTG3L-3	3"	¼"	8	0 – 75psi 0 – 517 kPa	60 – 320	16 – 160	N	2	51	3½/16	100	1	25	–	–

Series IWTG-Gas (2")

Air Test Assembly Gauges

- Available in 2" dial size
- Includes 3/4" (20mm) FPT x Schrader type air valve w/cap connection

MODEL	DIAL SIZE	SCALE	
IWTG-Gas 2	2"	0 – 15psi	0 – 103 kPa
IWTG-Gas 2	2"	0 – 30psi	0 – 207 kPa
IWTG-Gas 2	2"	0 – 60psi	0 – 413 kPa
IWTG-Gas 2	2"	0 – 100psi	0 – 689 kPa

For additional information,
request literature ES-IWTG-Gas.



IWTG-Gas

Series IWTG-NYC (2½")

Air Test Assembly Gauges

- 2% Accuracy, full range
- Includes 3/4" (20mm) FPT x Schrader type air valve w/cap connection
- Includes shutoff valve

MODEL	DIAL SIZE	SCALE	
IWTG-NYC	2½"	0 – 5psi	0 – 34 kPa
IWTG-NYC	2½"	0 – 10psi	0 – 69 kPa

For additional information,
request literature ES-IWTG-NYC-HTX.



IWTG-NYC

Series IWTG-HTX (4")

Air Test Assembly Gauges

- 1% Accuracy, full range
- Includes 3/4" (20mm) FPT x Schrader type air valve w/cap connection
- Includes shutoff valve
- Includes set hand

MODEL	DIAL SIZE	SCALE	
IWTG-HTX	4"	0 – 5psi	0 – 34 kPa
IWTG-HTX	4"	0 – 10psi	0 – 69 kPa

For additional information,
request literature ES-IWTG-NYC-HTX.



IWTG-HTX

Series TB (1½" – 4")

Center Back Entry Bimetal Thermometers

- Available in dial sizes: 1½", 2½", 3", 4"
- Includes ½" (15mm) NPT brass thermowell with set screw



TB

MODEL	DIAL SIZE	SCALE		PROBE SIZE	
		°F	°C	in.	mm
TB-1½-1	1½"	32 – 176	0 – 80	1	25
TB-2½-2	2½"	32 – 140	0 – 60	2	51
TB-2½-3	2½"	32 – 248	0 – 120	3	76
TB-2½-4	2½"	32 – 248	0 – 120	4	102
TB-3-2	3"	-22 – 122	-30 – 50	2	51
TB-3-2	3"	32 – 140	0 – 60	2	51
TB-3-2	3"	32 – 248	0 – 120	2	51
TB-3-4	3"	-22 – 122	-30 – 50	4	102
TB-3-4	3"	32 – 140	0 – 60	4	102
TB-3-4	3"	32 – 248	0 – 120	4	102
TB-4-2	4"	-22 – 122	-30 – 50	2	51
TB-4-2	4"	32 – 140	0 – 60	2	51
TB-4-2	4"	32 – 248	0 – 120	2	51
TB-4-4	4"	-22 – 122	-30 – 50	4	102
TB-4-4	4"	32 – 140	0 – 60	4	102
TB-4-4	4"	32 – 248	0 – 120	4	102

For additional information, request literature ES-TB.

Series TBR (3")

Bottom Entry Bimetal Thermometers

- Available in 3" dial size
- Includes ½" (15mm) NPT brass snap-in thermowell



TBR

MODEL	DIAL SIZE	SCALE		PROBE SIZE	
		°F	°C	in.	mm
TBR-3-2	3"	-22 – 122	-30 – 50	2	51
TBR-3-2	3"	32 – 248	0 – 120	2	51
TBR-3-3	3"	-22 – 122	-30 – 50	3	76
TBR-3-3	3"	32 – 140	0 – 60	3	76
TBR-3-4	3"	-22 – 122	-30 – 50	4	102
TBR-3-4	3"	32 – 140	0 – 60	4	102
TBR-3-4	3"	32 – 248	0 – 120	4	102

For additional information, request literature ES-TBR.

Series TBP (2½")

Pipe Mount Bimetal Thermometers

- Available in 2½" dial size
- Pipe mount – choice of spring mount (M) or strap mount (F)



TBP

MODEL	DIAL SIZE	SCALE	
		°F	°C
TBP-M-2½	2½"	32 – 248	0 – 120
TBP-F-2½	2½"	32 – 248	0 – 120

For additional information, request literature ES-TBP.

Series TBC (2½")

Center Back Entry Bimetal Thermometers

- Available in 2½" dial size
- Chimney mount-center back entry



TBC

MODEL	DIAL SIZE	SCALE		PROBE SIZE	
		°F	°C	in.	mm
TBC-2½-4	2½"	32 – 932	0 – 500	4	102
TBC-2½-6	2½"	32 – 932	0 – 500	6	152
TBC-2½-8	2½"	32 – 932	0 – 500	8	203
TBC-2½-12	2½"	32 – 932	0 – 500	12	305

For additional information, request literature ES-TBC.

Series TA (9")

Adjustable Angle Thermometers

- Available in 9" scale size

MODEL	TEMPERATURE RANGE		STEM SIZE	
	°F	°C	in.	mm
TA-9-3½	-40 – 110	-40 – 43	3½	89
TA-9-3½	0 – 120	-17 – 48	3½	89
TA-9-3½	0 – 160	-17 – 71	3½	89
TA-9-3½	30 – 240	28 – 115	3½	89
TA-9-3½	30 – 300	28 – 148	3½	89
TA-9-6	-40 – 110	-40 – 43	6	152
TA-9-6	0 – 120	-17 – 48	6	152
TA-9-6	0 – 160	-17 – 71	6	152
TA-9-6	30 – 240	28 – 115	6	152
TA-9-6	30 – 300	28 – 148	6	152



TA

For additional information, request literature ES-TA.

Series TL (5")

Angle Thermometers

- Available in 5" scale size

MODEL	TEMPERATURE RANGE		STEM SIZE	
	°F	°C	in.	mm
TL-5-2	-40 – 110	-40 – 43	1 ⁵ / ₁₆	33
TL-5-2	20 – 180	-6 – 82	1 ⁵ / ₁₆	33
TL-5-2	30 – 240	28 – 115	1 ⁵ / ₁₆	33
TL-5-2	30 – 300	28 – 148	1 ⁵ / ₁₆	33

For additional information, request literature ES-TL.



TL

Series G-TB, G-TBR (1/2")

Brass Thermowells

- **G-TB** with set screw for thermometer models TB and TBC
- **G-TBR** for thermometer model TBR

For additional information, request literature ES-G-TB or ES-B-TBR.



G-TB

Series TP (1/4", 1/2")

Test Plugs for Pressure and Temperature Test Readings

- Temperature and pressure probe inserts into the test plug for test readings
- No need to leave costly gauges in the supply line

Specifications

Used on various applications of gas, air, water or chemicals up to 500psi (34.5 bar). The pressure gauge adapter has a 0.076" (2mm) diameter probe of 300 series stainless steel with brass union nut. The probe operates in either 1/4" or 1/2" (8 or 15mm) NPT test plugs. Plug extensions are also available in 1/4" and 1/2" (8 and 15mm) NPT sizes to accommodate insulated pipe situations.

Models

TP-N: Neoprene (Blue) – Natural gas and petroleum products. Temperature range: -40°F to 200°F (-40°C to 93°C).

TP-E: EPDM (White) – Hot and cold water service. Temperature range: -40°F to 275°F (-40°C to 135°C).

TP-V: Viton (Green) – Hot oil service, chemical service. Temperature range: -10°F to 400°F (-23°C to 204°C).

For additional information, request literature ES-TP.



Features

- Economical means of balancing heating and air conditioning systems
- Eliminates shutting down system for temperature and pressure checks

OneFlow™ Anti-Scale System

Connection Sizes: ¾", 1", 1¼", and 2"

The OneFlow™ Anti-Scale System provides protection from scale formation on internal and external plumbing surfaces. OneFlow™ systems require very little maintenance, no backwashing, no salt and no electricity. Typical hardness problems, especially build-up of scale in pipes, water heaters, boilers and on fixtures are no longer a concern.

Features

- Chemical free scale prevention and protection
- Virtually maintenance free
- No control valve, electricity and no wastewater
- Improves efficiency of water using appliances
- Simple sizing and installation
- Cartridge, tank, and hot water applications

Models

Cartridge Style

OF110-1	1 gpm
OF120-2	2 gpm
OF140-4	4 gpm
OF210-1	1 gpm
OF220-2	2 gpm
OF240-4	4 gpm

Tank Style

OF744-10	10 gpm
OF844-12	12 gpm
OF948-16	16 gpm
OF1054-20	20 gpm
OF1252-30	30 gpm
OF1465-50	50 gpm
OF-1665-75	75 gpm

Hot Water

OF-817-8H	8 gpm
OF817-12H	12 gpm
OF1019-20H	20 gpm
OF1465-75H	75 gpm

Replacement Cartridges and Replacement Media available.

For further information, request ES-OF110_120_140, ES-OF210_220_240, ES-OF744_844_948_1054_1252, ES-OF1465_1665, ES-OneFlow-HotWater.



OF120-2



OF240-4



OF1252-30

Trademarks

Celcon® is a registered trademark of Celanese, Limited.

Noryl® is a registered trademark of General Electric Company.

Teflon® is a registered trademark of the E.I. DuPont de Nemours & Company.

Viton® is a registered trademark of DuPont Dow Elastomers.

For Technical Assistance Call Your Authorized Watts Agent.

			Telephone #	Fax #
	HEADQUARTERS: Watts Regulator Company	815 Chestnut St., North Andover, MA 01845-6098 U.S.A.	978 688-1811	978 794-1848
North East	BWA Company	17610 S. Waterloo Rd., Cleveland, OH 44119	216 486-1010	216 486-2860
	Disney McLane & Associates	428 McGregor Ave., Cincinnati, OH 45206	800 542-1682	877 476-1682
	Edwards, Platt & Deely, Inc.	277 Royal Ave., Hawthorne, NJ 07506	973 427-2898	973 427-4246
	Edwards, Platt & Deely, Inc.	368 Wyandanch Ave., North Babylon, NY 11703	631 253-0600	631 253-0303
	J. B. O'Connor Company, Inc.	P.O. Box 12927, Pittsburgh, PA 15241	724 745-5300	724 745-7420
	RMI	Glenfield Bus. Ctr., 2535 Mechanicsville Tpk., Richmond, VA 23223	804 643-7355	804 643-7380
	The Joyce Agency, Inc.	8442 Alban Rd., Springfield, VA 22150	703 866-3111	703 866-2332
	Vernon Bitzer Associates, Inc.	980 Thomas Drive, Warminster, PA 18974	215 443-7500	215 443-7573
	W. P. Haney Co., Inc.	51 Norfolk Ave., South Easton, MA 02375	508 238-2030	508 238-8353
	WMS Sales, Inc. (Main office)	9580 County Rd., Clarence Center, NY 14032	716 741-9575	716 741-4810
South East	Billingsley & Associates, Inc.	2728 Crestview Ave., Kenner, LA 70062-4829	504 602-8100	504 602-8106
	Billingsley & Associates, Inc.	478 Cheyenne Lane, Madison, MS 39110	601 856-7565	601 856-8390
	Francisco J. Ortiz & Co., Inc.	Charlyn Industrial Pk., Road 190 KM1.9 - Lot #8, Carolina, Puerto Rico 00983	787 769-0085	787 750-5120
	Mid-America Marketing, Inc.	203 Industrial Drive, Birmingham, AL 35211	205 879-3469	205 870-5027
	Mid-America Marketing, Inc.	1364 Foster Avenue, Nashville, TN 37210	615 259-9944	615 259-5111
	Mid-America Marketing, Inc.	5466 Old Hwy. 78, Memphis, TN 38118	800 365 6154	901 795-0394
	Smith & Stevenson Co., Inc.	4935 Chastain Ave., Charlotte, NC 28217	704 525-3388	704 525-6749
Harry Warren, Inc.	1400 North Orange Blossom Trail, Orlando, FL 32804	407 841-9237	407 841-9246	
Watts Georgia	2861-B Bankers Industrial Drive, Atlanta, GA 30360	770 209-3310	770 447-4583	
North Central	Dave Watson Associates	1325 West Beecher, Adrian, MI 49221	517 263-8988	517 263-2328
	Mid-Continent Marketing Services Ltd.	1724 Armitage Ct., Addison, IL 60101	630 953-1211	630 953-1067
	Soderholm & Associates, Inc.	7150 143rd Ave. N.W., Anoka, MN 55303	763 427-9635	763 427-5665
	Stickler & Associates	333 North 121 St., Milwaukee, WI 53226	414 771-0400	414 771-3607
South Central	Hugh M. Cunningham, Inc.	13755 Benchmark, Dallas, TX 75234	972 888-3808	972 888-3838
	HMC Sandia Group	13755 Benchmark, Dallas, TX 75234	505 222-3134	972 888-3838
	Mack McClain & Associates	4407 Meramec Bottom, Suite G, St. Louis, MO 63129	314 894-8188	314 894-8388
	Mack McClain & Associates, Inc.	1450 NE 69th Place, Ste. 56 Ankeny, IA 50021	515 288-0184	515 288-5049
	Mack McClain & Associates, Inc.	15090 West 116th St., Olathe, KS 66062	913 339-6677	913 339-9518
	OK! Sales, Inc.	214-A NE 12th., Moore, OK 73160	405 794-5200	405 794-5250
Western	Delco Sales, Inc.	1930 Raymer Ave., Fullerton, CA 92833	714 888-2444	714 888-2448
	Delco Sales, Inc.	111 Sand Island Access Rd., Unit I-10, Honolulu, HI 96819	808 842-7900	808 842-9625
	Fanning & Associates, Inc.	6765 Franklin St., Denver, CO 80229-7111	303 289-4191	303 286-9069
	Hollabaugh Brothers & Associates	6915 South 194th St., Kent, WA 98032	253 867-5040	253 867-5055
	Hollabaugh Brothers & Associates	3028 S.E. 17th Ave., Portland, OR 97202	503 238-0313	503 235-2824
	P I R Sales, Inc.	3050 North San Marcos Place, Chandler, AZ 85225	480 892-6000	480 892-6096
	Preferred Sales	31177 Wiegman Road, Hayward, CA 94544	510 487-9755	510 476-1595
	R. E. Fitzpatrick Sales, Inc.	4109 West Nike Dr. (8250 South), West Jordan, UT 84088	801 282-0700	801 282-0600
Canada	Watts Industries (Canada) Inc. (Watts Regulator Co. Division)	5435 North Service Road, Burlington, Ontario L7L 5H7	905 332-4090	905 332-7068
	Con-Cur West Marketing, Inc.	71B Clipper Street, Coquitlam, British Columbia V3K 6X2	604 540-5088	604 540-5084
	D.C. Sales Ltd.	#13-6130 4th St. S.E., Calgary, Alberta T2H 2B6	403 253-6808	403 259-8331
	D.C. Sales Ltd.	16726 111 Ave, Edmonton, Alberta T5M 2S6	780 496-9495	780 496-9621
	GTA Sales Team.	Greater Toronto Area	888 208-8927	888 479-2887
	Hydro-Mechanical Sales, Ltd.	3700 Joseph Howe Drive, Suite 1, Halifax, Nova Scotia B3L 4H7	902 443-2274	902 443-2275
	Hydro-Mechanical Sales, Ltd.	P.O. Box 1445 (Mailing), 297 Collishaw St., Suite 7 (shipping) Moncton, New Brunswick E1C 9R2	506 859-1107	506 859-2424
	J.D.S. Sales Ltd.	4 Lancaster Street, St. John's, Newfoundland A1A 5P7	709 579-5771	709 579-1558
	Les Ent. Roland Lajoie	6221 Marivault, St-Leonard, QC H1P 3H6	514 328-6645	514 328-6131
	Les Ent. Roland Lajoie	23 du Buisson, Pont Rouge, QC G3H 1X9	418 873-2500	418 873-2505
	Mar-Win Agencies, Ltd.	1333 Clifton St., Winnipeg, Manitoba R3E 2V1	204 775-8194	204 786-8016
	Northern Mechanical Sales	P.O. Box 280 (mailing) 163 Pine St. (shipping), Garson, Ontario P3L 1S6	705 693-2715	705 693-4394
	Palser Enterprises, Ltd.	P.O. Box 28136 (mailing), 1885 Blue Heron Dr., #4, London, Ontario N6H 5L9	519 471-9382	519 471-1049
RAM Mechanical Marketing Inc.	905 Winnipeg Street, Regina, Saskatchewan S4R 1J1	306 525-1986	306 525-0809	
RAM Mechanical Marketing Inc.	510 Ave M South, Saskatoon, Saskatchewan S7M 2K9	306 244-6622	306 244-0807	
Walmar Mechanical Sales	24 Gurdwara Rd., Nepean, Ontario K2E 8B5	613 225-9774	613 225-0673	
	EXPORT Hdqtrs.: Watts Regulator Co.	815 Chestnut St., North Andover, MA 01845-6098 U.S.A.	978 688-1811	978 794-1848

0832



Water Safety & Flow Control Products



USA: 815 Chestnut St., No. Andover, MA 01845-6098; www.watts.com

Canada: 5435 North Service Rd., Burlington, ONT. L7L 5H7; www.wattscanada.ca