



TECHNICAL DATA

SPECIFIC APPLICATION WINDOW SPRINKLERS (K5.6)

The Viking Corporation, 210 N Industrial Park Drive, Hastings MI 49058

Telephone: 269-945-9501 Technical Services: 877-384-5464 Fax: 269-818-1680 Email: techsvcs@vikingcorp.com

Visit the Viking website for the latest edition of this technical data page www.vikinggroupinc.com

1. DESCRIPTION

Viking Specific Application window sprinklers are quick response glass bulb, automatic sprinklers. Both Pendent Vertical Sidewall (VSW) and Horizontal Sidewall (HSW) versions are available to meet design needs.

The special Polyester and Electroless Nickel PTFE (ENT) coatings can be used in decorative applications where colors are desired. In addition, these coatings have been investigated for installation in corrosive environments and are listed/approved as indicated in the Approval Charts.

2. LISTINGS AND APPROVALS



cULus Listed: Category VNIV



Evaluation Report No. UL ER643-01

Refer to the Approval Chart and Design Criteria for listing requirements that must be followed. For information on the evaluation report, see <https://database.ul.com/certs/ER643-01.pdf>.

3. TECHNICAL DATA

Minimum Operating Pressure: 7 psi (0.5 bar)

Rated to: 175 PSI (12 bar)

Factory tested hydrostatically to 500 psi (34.5 bar).

Thread size: 1/2" NPT (15 mm BSPT)

Nominal K-factor: 5.6 U.S. (80.6 metric*)

Glass-bulb fluid temperature rated to -65 °F (-55 °C)

* Metric K-factor measurement shown is in Bar. When pressure is measured in kPa, divide the metric K-factor shown by 10.0.

Material Standards:

Sprinkler Body: Brass CW602N or QM Brass

Deflector: Phosphor Bronze UNS-C51000

Pip Cap Shell - Stainless Steel UNS-S44400

Pip Cap Disc - Stainless Steel UNS-S30100

Belleville Spring - Nickel Alloy

Pip Cap Seal - Polytetrafluoroethylene (PTFE)

Compression Screw: Brass CW612N, CW508L, UNS-C36000 or UNS-C26000

Shipping Cap: Polyethylene

Bulb: Glass, nominal 3 mm diameter

Ordering Information: Refer to Table 1

4. INSTALLATION

Refer to appropriate NFPA Installation Standards. Also refer to Figures 3 through 6.



SIN	THREAD	DESCRIPTION
VK960	NPT	Pendent VSW
VK960	BSPT	Pendent VSW
VK962	NPT	HSW
VK962	BSPT	HSW



WARNING: Cancer and Reproductive Harm-
www.P65Warnings.ca.gov

NOTICE Risk of permanent damage.

Over-tightening the sprinkler can cause permanent damage.
> Tighten the sprinkler to a **MAXIMUM** torque of 14 ft-lbs. (19 N-m).

**TECHNICAL DATA****SPECIFIC APPLICATION
WINDOW SPRINKLERS
(K5.6)**

The Viking Corporation, 210 N Industrial Park Drive, Hastings MI 49058
Telephone: 269-945-9501 Technical Services: 877-384-5464 Fax: 269-818-1680 Email: techsvcs@vikingcorp.com
Visit the Viking website for the latest edition of this technical data page www.vikinggroupinc.com

5. OPERATION

During fire conditions, when the temperature around the sprinkler reaches its operating temperature, the heat-sensitive liquid in the glass bulb expands, causing the bulb to shatter, releasing the pip cap assembly. Water flowing through the sprinkler orifice strikes the sprinkler deflector, forming a uniform spray pattern to extinguish or control the fire.

6. INSPECTIONS, TESTS AND MAINTENANCE

Refer to NFPA 25 for Inspection, Testing and Maintenance requirements.

7. AVAILABILITY

Viking automatic window sprinklers are available through a network of domestic and international distributors. See The Viking Corporation web site for the closest distributor or contact The Viking Corporation.

8. GUARANTEE

For details of warranty, refer to Viking's current list price schedule or contact Viking directly.

	TECHNICAL DATA	SPECIFIC APPLICATION WINDOW SPRINKLERS (K5.6)
---	-----------------------	--

The Viking Corporation, 210 N Industrial Park Drive, Hastings MI 49058
 Telephone: 269-945-9501 Technical Services: 877-384-5464 Fax: 269-818-1680 Email: techsvcs@vikingcorp.com
 Visit the Viking website for the latest edition of this technical data page www.vikinggroupinc.com

TABLE 1: SPRINKLER ORDERING INFORMATION

Instructions: Using the sprinkler base part number,
(1) add the suffix for the desired Finish
(2) add the suffix for the desired Temperature Rating.

SIN	Sprinkler Base Part Number	Style	Size		1: Finishes		2: Temperature Ratings				
			NPT Inch	BSPT mm	Description	Suffix ¹	Sprinkler Temperature Classification	Nominal Rating	Max. Ambient Ceiling Temperature ²	Bulb Color	Suffix
VK960	23832	Pendent VSW	1/2	--	Brass	A	Ordinary	155 °F (68 °C)	100 °F (38 °C)	Red	B
VK960	23829	Pendent VSW	--	15	Chrome	F	Intermediate	200 °F (93 °C)	150 °F (65 °C)	Green	E
VK962	23834	HSW	1/2	--	White Polyester	M-/W	Corrosion Resistant Sprinkler Finish: ENT Example: 23832JNE = VK960, 200 °F (93 °C) Temperature Rated Sprinkler with an ENT^{3,4} finish.				
VK962	23831	HSW	--	15	Black Polyester	M-/B					
					ENT ^{3,4}	JN					

Accessories

Sprinkler Wrenches and tools:

Standard Wrench Part Number: 23559MB

Sprinkler Cabinet:

Holds up to 6 sprinklers: Part number 01724A

Footnotes

1. Where a dash (-) is shown in the Finish suffix designation, insert the desired Temperature Rating suffix. See example above.
2. Based on NFPA 13. Other limits may apply, depending on fire loading, sprinkler location, and other requirements of the Authority Having Jurisdiction. Refer to specific installation standards.
3. cULus Listed as corrosion resistant.
4. The corrosion resistant coatings have passed the standard corrosion test required by the approving agencies indicated in the Approval Chart. These tests cannot and do not represent all possible corrosive environments. Prior to installation, verify through the end-user that the coatings are compatible with or suitable for the proposed environment. For automatic sprinklers, the ENT coating is applied to all exposed exterior surfaces, including the waterway.

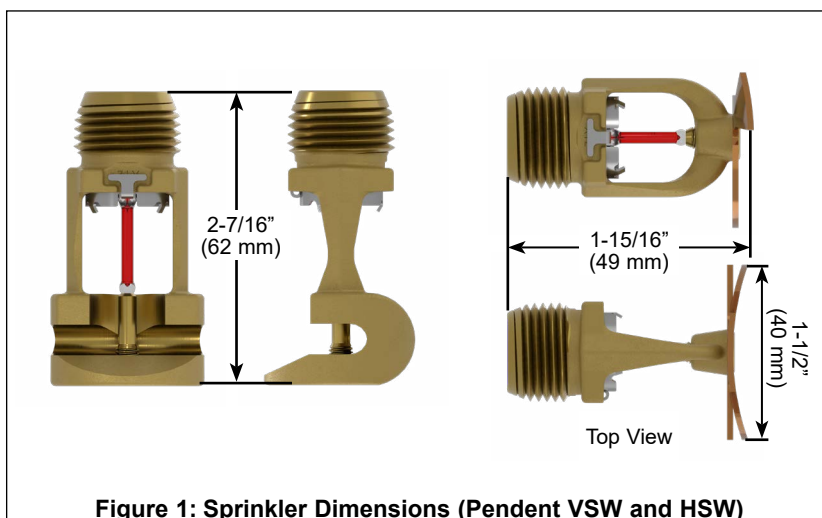

	TECHNICAL DATA	SPECIFIC APPLICATION WINDOW SPRINKLERS (K5.6)
---	-----------------------	--

The Viking Corporation, 210 N Industrial Park Drive, Hastings MI 49058
Telephone: 269-945-9501 Technical Services: 877-384-5464 Fax: 269-818-1680 Email: techsvcs@vikingcorp.com
Visit the Viking website for the latest edition of this technical data page www.vikinggroupinc.com

APPROVAL CHART Viking Specific Application Pendent Vertical Sidewall Window Sprinklers VK960 K5.6 (80.6 metric) Maximum 175 PSI (12 Bar) WWP										
			<table border="1" style="font-size: small;"> <tr> <td>Finish(es) →</td> <td>↓</td> <td rowspan="3" style="text-align: center; vertical-align: middle;">KEY</td> </tr> <tr> <td>Temperature(s) →</td> <td>→ A 1 X</td> </tr> <tr> <td>Escutcheon(s), If applicable →</td> <td>↗</td> </tr> </table>	Finish(es) →	↓	KEY	Temperature(s) →	→ A 1 X	Escutcheon(s), If applicable →	↗
Finish(es) →	↓	KEY								
Temperature(s) →	→ A 1 X									
Escutcheon(s), If applicable →	↗									
Sprinkler Base Part Number ¹	Thread Size		Listings and Approvals ²							
	NPT Inch	BSPT mm	cULus							
23832	1/2	--	A1							
23829	--	15	A1							
Approved Temperature Rating Codes: A = 155 °F (68 °C) and 200 °F (93 °C)										
Approved Finish Codes: 1 = Brass, Chrome, White Polyester ^{3,4}, Black Polyester ^{3,4}, and ENT ⁴										
Footnotes ¹ Base Part number is shown. For complete part number, refer to Viking's current price schedule. ² This table shows the listings and approvals available at the time of publication. Check with the manufacturer for any additional approvals. ³ Other colors are available upon request with the same Listings and Approvals as the standard colors. ⁴ cULus Listed as corrosion resistant.										

APPROVAL CHART Viking Specific Application Horizontal Sidewall Window Sprinklers VK962 K5.6 (80.6 metric) Maximum 175 PSI (12 Bar) WWP										
			<table border="1" style="font-size: small;"> <tr> <td>Finish(es) →</td> <td>↓</td> <td rowspan="3" style="text-align: center; vertical-align: middle;">KEY</td> </tr> <tr> <td>Temperature(s) →</td> <td>→ A 1 X</td> </tr> <tr> <td>Escutcheon(s), If applicable →</td> <td>↗</td> </tr> </table>	Finish(es) →	↓	KEY	Temperature(s) →	→ A 1 X	Escutcheon(s), If applicable →	↗
Finish(es) →	↓	KEY								
Temperature(s) →	→ A 1 X									
Escutcheon(s), If applicable →	↗									
Sprinkler Base Part Number ¹	Thread Size		Listings and Approvals ²							
	NPT Inch	BSPT mm	cULus							
23834	1/2	--	A1							
23831	--	15	A1							
Approved Temperature Rating Codes: A = 155 °F (68 °C) and 200 °F (93 °C)										
Approved Finish Codes: 1 = Brass, Chrome, White Polyester ^{3,4}, Black Polyester ^{3,4}, and ENT ⁴										
Footnotes ¹ Base Part number is shown. For complete part number, refer to Viking's current price schedule. ² This table shows the listings and approvals available at the time of publication. Check with the manufacturer for any additional approvals. ³ Other colors are available upon request with the same Listings and Approvals as the standard colors. ⁴ cULus Listed as corrosion resistant.										



TECHNICAL DATA

SPECIFIC APPLICATION WINDOW SPRINKLERS (K5.6)

The Viking Corporation, 210 N Industrial Park Drive, Hastings MI 49058
 Telephone: 269-945-9501 Technical Services: 877-384-5464 Fax: 269-818-1680 Email: techsvcs@vikingcorp.com
 Visit the Viking website for the latest edition of this technical data page www.vikinggroupinc.com

DESIGN CRITERIA - Pendent Vertical Sidewall Window Sprinkler VK960

(Also refer to the Approval Chart.)

cULus Listing Requirements:

Viking Specific Application Pendent Vertical Sidewall Pendent Sprinkler VK960 is cULus Listed as a Specific Application Window Sprinkler for interior use and as an open sprinkler for Outside use; refer to the installation standards such as NFPA 13 for minimum water supply requirements, pressures, and installation guidelines. In addition, the following requirements must be met:

System Types:

- For Interior sprinklers: Wet Systems
- For Outdoor sprinklers: Deluge systems

Areas of Use:

Consult an Authority Having Jurisdiction (AHJ) for local standards, codes, or other requirements. These sprinklers are intended for use in either a sprinklered or unsprinklered building to protect non-operable window areas that are part of a fire separation, only if the following apply:

- Refer to Figure 3A. For interior separations, the sprinklers must be installed on both sides of the window within the fire separation.
- Refer to Figure 3B. For areas where separation from an adjacent space is defined as protecting an adjacent structure from a fire in the building being protected, the sprinklers must be installed on the interior side of the building, OR
- Refer to Figure 3C. For areas where exterior spatial separation is defined as exposure protection, open window sprinklers must be installed on the exterior portion of the building.

Glass Types:

The following specifications must apply in order for the Viking Specific Application Window Sprinkler to be used.

- Type: Non-operable and/or stronger assemblies
- Treatments: heat-strengthened and tempered, compliant with ASTM C1048 or Federal Specification DD-G-1403B.
- Glazing: single-glazed/single pane, double-glazed/double pane or insulated.
- Thickness: Minimum 1/4" (6.35 mm)

Window Frame/Mullion Types:

Non combustible with EPDM rubber gasket; Vertical joints of glass panes must be connected by butt-joints using a silicone sealant between the individual panes or by noncombustible mullions. Refer to Figures 4A and 4B.

Maximum Length of Window: Unlimited

Maximum Height of Window: 13' (4.0 m) Refer to Figure 5.

Maximum distance between sprinklers: 12' (3.658 m) Refer to Figures 4A and 4B

Minimum distance between sprinklers: 6' (1.828 m). Refer to Figures 4A and 4B (unless separated by a mullion meeting depth of a baffle; mullion must extend to the back of the sprinkler deflector.)

Minimum flow per sprinkler: 15 gpm (57 Lpm)

Maximum pressure: 175 PSI (12 bar)

Minimum distance from standard sprinklers: 6' (1.828 m) unless separated by a baffle

Maximum distance from vertical mullion: 7' (2.133 m) Refer to figure 4A

Minimum distance from vertical mullions: 4" (102 mm)

Deflector Location:

Sprinkler Deflectors must be located as described below in order to ensure that the entire surface of the glazing window is covered. Sprinkler Deflectors are positioned with respect to the window frame, not the ceiling.

- Pendent Vertical Sidewall: Locate 4" to 12" (102 mm to 305 mm) from the face of the glazing and 2" to 4" (51 mm to 102 mm) down from the top of the metallic frame. Refer to Figure 5A.

Minimum clearance to face of glass to combustible materials: 2" (51 mm)

Escutcheons: Standard surface mount or raised escutcheons may be used.

Minimum flow per sprinkler: 15 gpm (56.8 Lpm)

Continues on next page.



TECHNICAL DATA

**SPECIFIC APPLICATION
WINDOW SPRINKLERS
(K5.6)**

The Viking Corporation, 210 N Industrial Park Drive, Hastings MI 49058
 Telephone: 269-945-9501 Technical Services: 877-384-5464 Fax: 269-818-1680 Email: techsvcs@vikingcorp.com
 Visit the Viking website for the latest edition of this technical data page www.vikinggroupinc.com

DESIGN CRITERIA - Pendent Vertical Sidewall Window Sprinkler VK960

(Also refer to the Approval Chart.)

Continued from previous page.

Interior protection sprinklered building: Identify which compartmented area has the most hydraulically demanding window sprinklers. Calculate up to the most demanding 46.5 linear feet (14.2 linear meters) of window sprinklers on one side of the glazing. The 46.5 linear feet (14.2 linear meters) is based upon 1.2 x the square root of the system area of operation, when the system area of operation is 1500 ft² (140 m²). in accordance with NFPA 13 Light/Ordinary Hazard density curves.

Where the area of Glazing is less than 46.5 linear feet (14.2 linear meters), all window sprinklers on one side shall be calculated. If an area reduction for quick response sprinklers is utilized, the linear length of the calculated window sprinklers may be reduced, but in no case shall be less than 36 linear feet (1.2 x √900).

If a single fire can be expected to operate window sprinklers and sprinklers within the design area of a hydraulically calculated system, the water demand of the window sprinklers shall be added to the water demand of the hydraulic calculations and shall be balanced to the calculated area demand.

If the window sprinklers are located in an area other than the hydraulic design area, the demand of the window sprinklers is not required to be added to the demand of the remote hydraulic design area. However, it is necessary to prove hydraulically the simultaneous operation of the window sprinklers and the ceiling sprinklers adjacent to the window sprinklers.

Interior protection of non-sprinklered building: Calculate all sprinklers on the most demanding side of the glazing assembly within the enclosure.

Exterior exposure protection: Calculate all sprinklers controlled by the deluge valve using the design requirements of NFPA.

Duration of water supply: Duration of water supply must comply with requirements of NFPA. If window sprinklers are used to provide the equivalency of a fire rating, the water supply must be capable of supplying water for the required rating period.

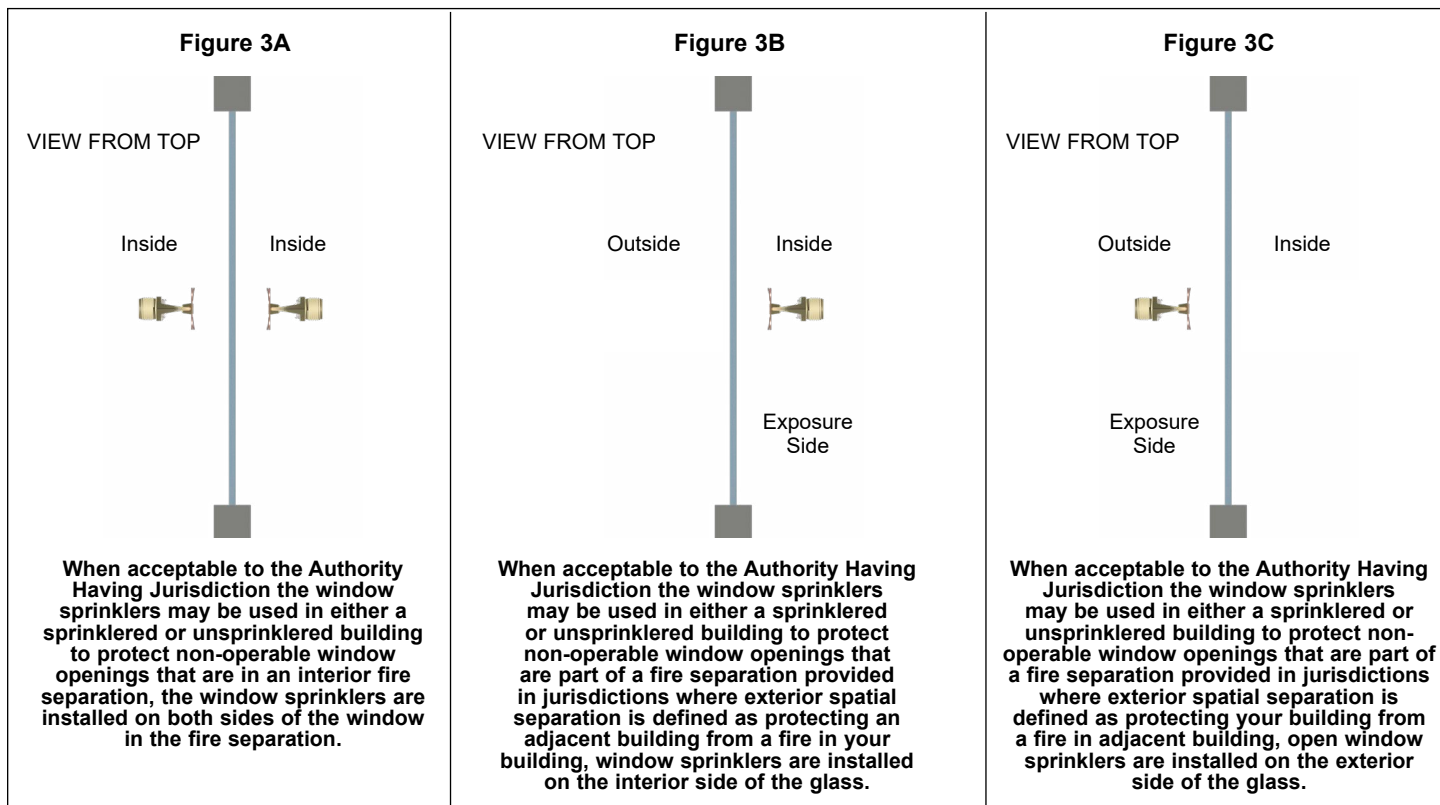

Figure 3: Typical Non-Operable Windows



TECHNICAL DATA

SPECIFIC APPLICATION WINDOW SPRINKLERS (K5.6)

The Viking Corporation, 210 N Industrial Park Drive, Hastings MI 49058
 Telephone: 269-945-9501 Technical Services: 877-384-5464 Fax: 269-818-1680 Email: techsvcs@vikingcorp.com
 Visit the Viking website for the latest edition of this technical data page www.vikinggroupinc.com

DESIGN CRITERIA - Horizontal Sidewall Window Sprinkler VK962

(Also refer to the Approval Chart.)

cULus Listing Requirements:

Viking Specific Application Horizontal Sidewall Sprinkler VK962 is cULus Listed as a Specific Application Window Sprinkler for interior use and as an open sprinkler for Outside use; refer to the installation standards such as NFPA 13 for minimum water supply requirements, pressures, and installation guidelines. In addition, the following requirements must be met:

System Types:

- For Interior sprinklers: Wet Systems
- For Outdoor sprinklers: Deluge systems

Areas of Use:

Consult an Authority Having Jurisdiction (AHJ) for local standards, codes, or other requirements. These sprinklers are intended for use in either a sprinklered or unsprinklered building to protect non-operable window areas that are part of a fire separation, only if the following apply:

- Refer to Figure 3A. For interior separations, the sprinklers must be installed on both sides of the window within the fire separation.
- Refer to Figure 3B. For areas where separation from an adjacent space is defined as protecting an adjacent structure from a fire in the building being protected, the sprinklers must be installed on the interior side of the building, OR
- Refer to Figure 3C. For areas where exterior spatial separation is defined as exposure protection, open window sprinklers must be installed on the exterior portion of the building.

Glass Types:

The following specifications must apply in order for the Viking Specific Application Window Sprinkler to be used.

- Type: Non-operable and/or stronger assemblies
- Treatments: heat-strengthened and tempered
- Glazing: single-glazed/single pane, double-glazed/double pane or insulated.
- Thickness: Minimum 1/4" (6.35 mm)

Window Frame/Mullion Types:

Non combustible with EPDM rubber gasket; Vertical joints of glass panes must be connected by butt-joints using a silicone sealant between the individual panes or by noncombustible mullions. Refer to Figures 4A and 4B.

Maximum Length of Window: Unlimited

Maximum Height of Window: 13' (3.962 m) Refer to Figure 5.

Maximum distance between sprinklers: 8' (2.438 m) Refer to Figures 4A and 4B.

Minimum distance between sprinklers: 6' (1.829 m) Refer to Figures 4A and 4B (unless separated by a mullion meeting depth of a baffle; mullion must extend to the back of the sprinkler deflector.)

Maximum pressure: 175 PSI (12 bar)

Minimum distance from standard sprinklers: 6' (1.829 m) unless separated by a baffle

Maximum distance from vertical mullion: 5' (1.524 m) Refer to Figure 4A

Minimum distance from vertical mullions: 4" (102 mm)

Deflector Location:

Sprinkler Deflectors must be located as described below in order to ensure that the entire surface of the glass window is covered. Sprinkler Deflectors are positioned with respect to the window frame, not the ceiling.

- Horizontal Sidewall: Locate within the outside edge of the window frame from 1/2" to 4" (13 mm to 102 mm) away from the glass and 1" to 3" (25 mm to 76 mm) down from the top of the exposed glass. Refer to Figure 5B.

Minimum clearance to face of glass to combustible materials: 2" (51 mm)

Escutcheons: Standard surface mount or raised escutcheons may be used.

Minimum flow per sprinkler: 20 gpm (75.7 Lpm) for sprinkler spacing of 6' to 8' (1.829 m to 2.438 m) or 15 gpm (56.8 Lpm) for sprinkler spacing less than 6' (1.829 m).

Continues on next page.



TECHNICAL DATA

SPECIFIC APPLICATION WINDOW SPRINKLERS (K5.6)

The Viking Corporation, 210 N Industrial Park Drive, Hastings MI 49058
 Telephone: 269-945-9501 Technical Services: 877-384-5464 Fax: 269-818-1680 Email: techsvcs@vikingcorp.com
 Visit the Viking website for the latest edition of this technical data page www.vikinggroupinc.com

DESIGN CRITERIA - Horizontal Sidewall Window Sprinkler VK962

(Also refer to the Approval Chart.)

Continued from previous page.

Interior protection sprinklered building: Identify which compartmented area has the most hydraulically demanding window sprinklers. Calculate up to the most demanding 46.5 linear feet (14.2 linear meters) of window sprinklers on one side of the glazing. The 46.5 linear feet (14.2 linear meters) is based upon $1.2 \times$ the square root of the system area of operation, when the system area of operation is 1500 ft² (140 m²). in accordance with NFPA 13 Light/Ordinary Hazard density curves.

Where the area of Glazing is less than 46.5 linear feet (14.2 linear meters), all window sprinklers on one side shall be calculated. If an area reduction for quick response sprinklers is utilized, the linear length of the calculated window sprinklers may be reduced, but in no case shall be less than 36 linear feet ($1.2 \times \sqrt{900}$).

If a single fire can be expected to operate window sprinklers and sprinklers within the design area of a hydraulically calculated system, the water demand of the window sprinklers shall be added to the water demand of the hydraulic calculations and shall be balanced to the calculated area demand.

If the window sprinklers are located in an area other than the hydraulic design area, the demand of the window sprinklers is not required to be added to the demand of the remote hydraulic design area. However, it is necessary to prove hydraulically the simultaneous operation of the window sprinklers and the ceiling sprinklers adjacent to the window sprinklers.

Interior protection non-sprinklered building: Calculate all sprinklers on the most demanding side of the glazing assembly within the enclosure.

Exterior exposure protection: Calculate all sprinklers controlled by the deluge valve using the design requirements of NFPA.

Duration of water supply: Duration of water supply must comply with requirements of NFPA. If window sprinklers are used to provide the equivalency of a fire rating, the water supply must be capable of supplying water for the required rating period.



TECHNICAL DATA

SPECIFIC APPLICATION
WINDOW SPRINKLERS
(K5.6)

The Viking Corporation, 210 N Industrial Park Drive, Hastings MI 49058
 Telephone: 269-945-9501 Technical Services: 877-384-5464 Fax: 269-818-1680 Email: techsvcs@vikingcorp.com
 Visit the Viking website for the latest edition of this technical data page www.vikinggroupinc.com

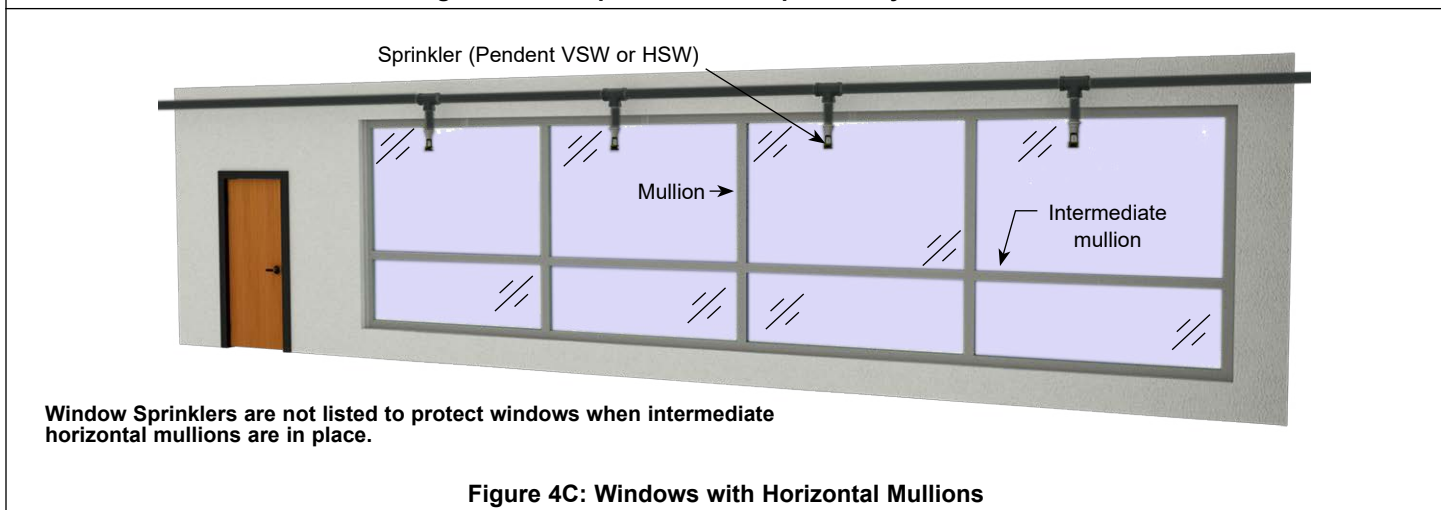
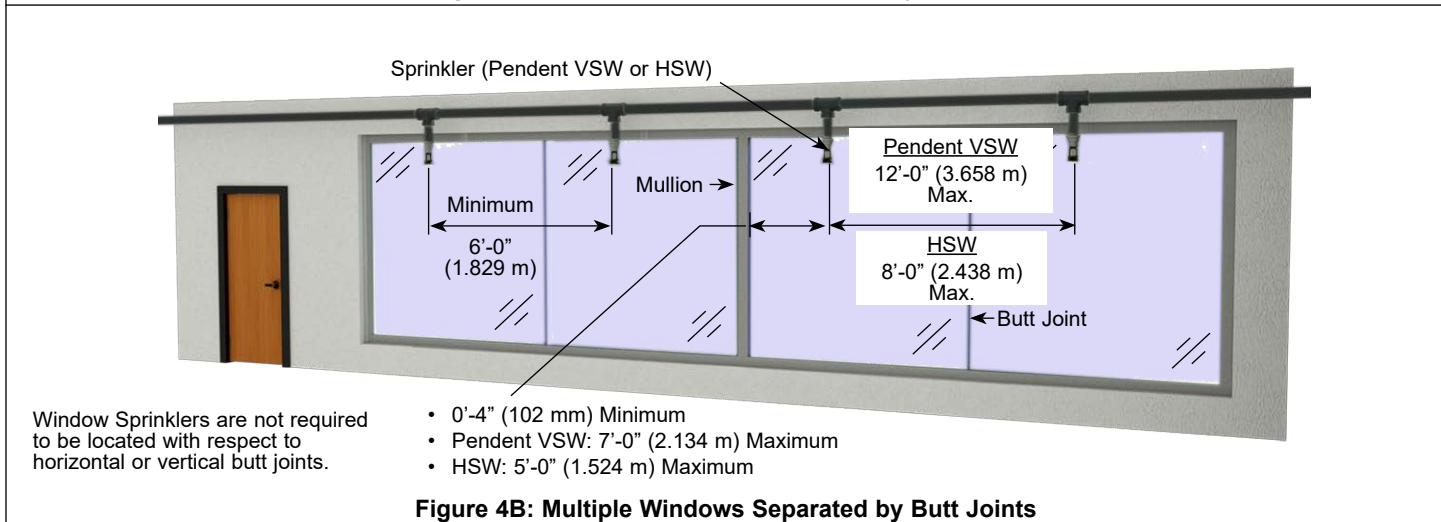
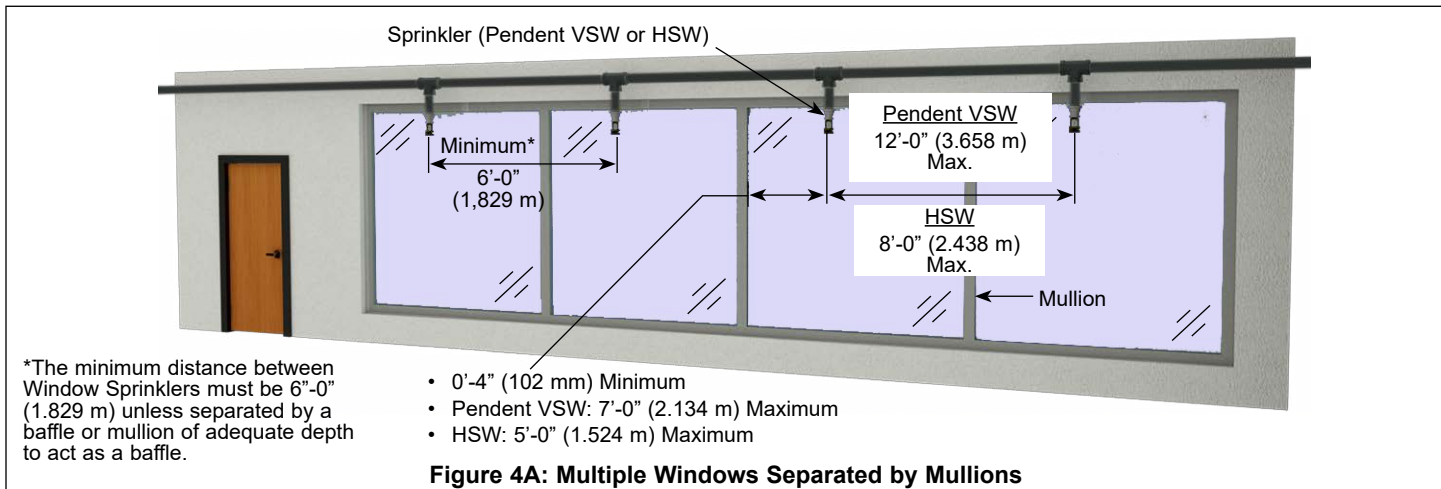



TECHNICAL DATA

SPECIFIC APPLICATION
WINDOW SPRINKLERS
(K5.6)

The Viking Corporation, 210 N Industrial Park Drive, Hastings MI 49058
 Telephone: 269-945-9501 Technical Services: 877-384-5464 Fax: 269-818-1680 Email: techsvcs@vikingcorp.com
 Visit the Viking website for the latest edition of this technical data page www.vikinggroupinc.com

Figure 5A: Pendent Vertical Sidewall

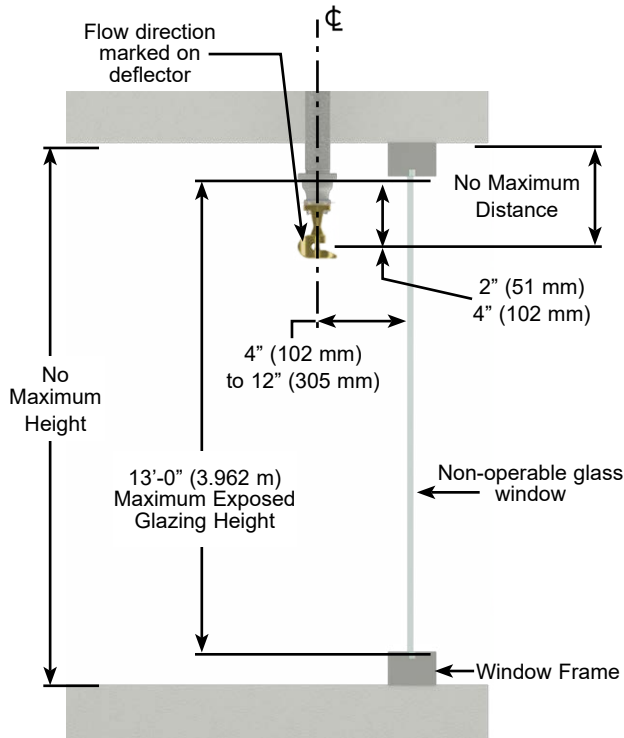
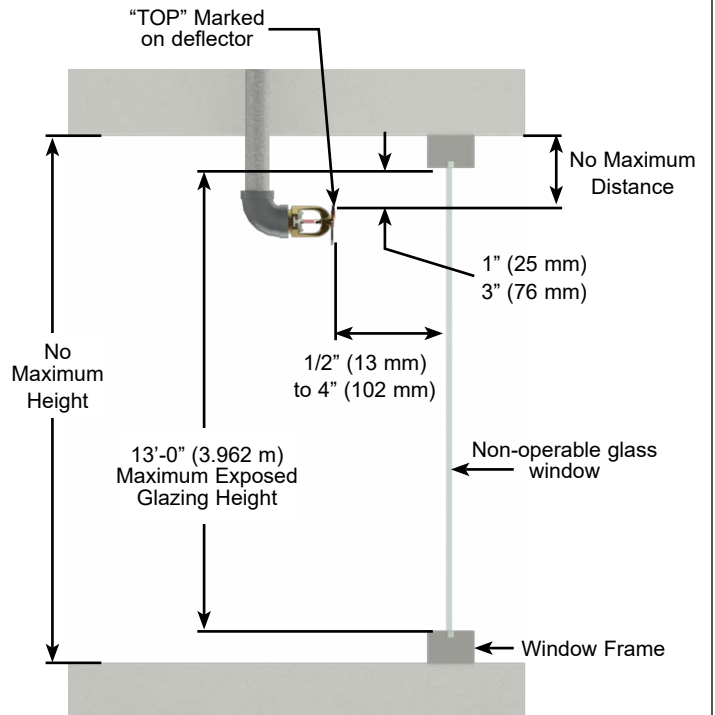

Figure 5B: Horizontal Sidewall



NOTE: Position the sprinkler with the frame arms aligned parallel to glazing and deflector flow indicator pointed towards glazing.

NOTE: Position the sprinkler with the frame arms aligned vertically and marked side of the deflector facing parallel to glazing.

All combustible materials must be kept a minimum of 2" (51 mm) from the sprinklered face of the glazing. A minimum 3'-0" (914 mm) pony wall may be used or other method acceptable to the Authority Having Jurisdiction

Do not use any type of window coverings between the sprinkler and the glazing.

Figure 5: Installation Dimensions



TECHNICAL DATA

**SPECIFIC APPLICATION
WINDOW SPRINKLERS
(K5.6)**

The Viking Corporation, 210 N Industrial Park Drive, Hastings MI 49058
 Telephone: 269-945-9501 Technical Services: 877-384-5464 Fax: 269-818-1680 Email: techsvcs@vikingcorp.com
 Visit the Viking website for the latest edition of this technical data page www.vikinggroupinc.com

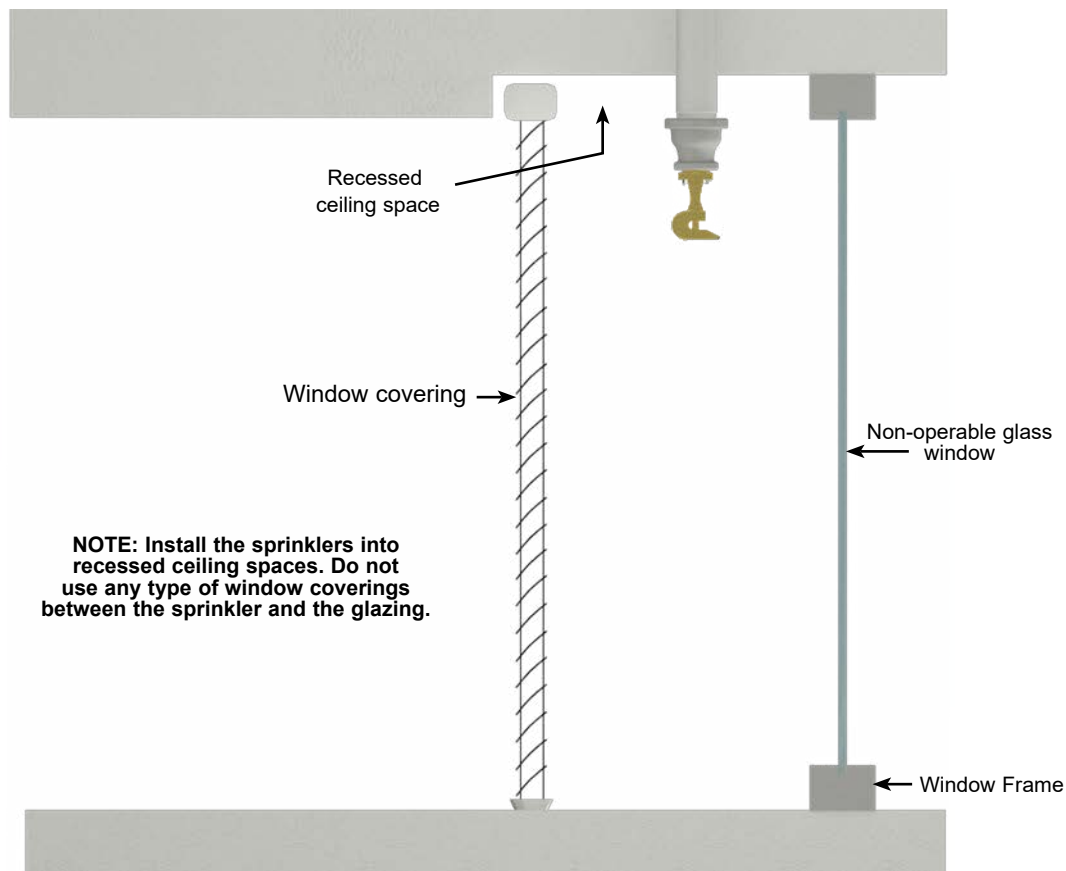

All combustible materials must be kept a minimum of 2" (51 mm) from the sprinklered face of the glazing. A minimum 3'-0" (914 mm) pony wall may be used or other method acceptable to the Authority Having Jurisdiction.

Figure 6: Recessed Ceiling Space Installation



BULLETIN

CARE AND HANDLING OF SPRINKLERS

The Viking Corporation, 210 N Industrial Park Drive, Hastings MI 49058
 Telephone: 269-945-9501 Technical Services: 877-384-5464 Fax: 269-818-1680 Email: techsvcs@vikingcorp.com

SPRINKLERS ARE FRAGILE - HANDLE WITH CARE!

General Handling and Storage:

- Store sprinklers in a cool, dry place.
- Protect sprinklers during storage, transport, handling, and after installation.
- Use the original shipping containers. DO NOT place sprinklers loose in boxes, bins, or buckets.
- Keep sprinklers separated at all times. DO NOT allow metal parts to contact sprinkler operating elements.

For Pre-Assembled Drops:

- Protect sprinklers during handling and after installation.
- For recessed assemblies, use the protective sprinkler cap (Viking Part Number 10364).

Sprinklers with Protective Shields or Caps:

- DO NOT remove shields or caps until after sprinkler installation and there no longer is potential for mechanical damage to the sprinkler operating elements.
- **Sprinkler shields or caps MUST be removed BEFORE placing the system in service!**
- Remove the sprinkler shield by carefully pulling it apart where it is snapped together.
- Remove the cap by turning it slightly and pulling it off the sprinkler.

Sprinkler Installation:

- DO NOT use the sprinkler deflector or operating element to start or thread the sprinkler into a fitting.
- **Use only the designated sprinkler head wrench!** Refer to the current sprinkler technical data page to determine the correct wrench for the model of sprinkler used.
- DO NOT install sprinklers onto piping at the floor level.
- Install sprinklers after the piping is in place to prevent mechanical damage.
- DO NOT allow impacts such as hammer blows directly to sprinklers or to fittings, pipe, or couplings in close proximity to sprinklers. Sprinklers can be damaged from direct or indirect impacts.
- DO NOT attempt to remove drywall, paint, etc., from sprinklers.
- **Take care not to over-tighten the sprinkler and/or damage its operating parts!**

Maximum Torque:

- 1/2" NPT: 14 ft-lbs. (19.0 N-m)**
- 3/4" NPT: 20 ft-lbs. (27.1 N-m)**
- 1" NPT: 30 ft-lbs. (40.7 N-m)**



CORRECT
(Original container used)

INCORRECT
(Placed loose in box)

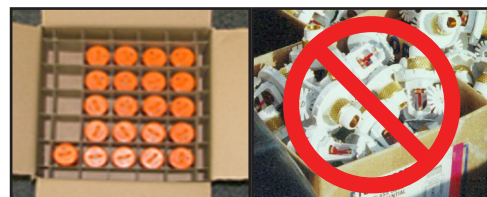

CORRECT
(Protected with caps)

INCORRECT
(Protective caps not used)



CORRECT
(Piping is in place at the ceiling)

INCORRECT
(Sprinkler at floor level)



CORRECT
(Special installation wrenches)

INCORRECT
(Designated wrench not used)

 **WARNING:** Cancer and Reproductive Harm-
www.P65Warnings.ca.gov

! WARNING

Any sprinkler with a loss of liquid from the glass bulb or damage to the fusible element should be destroyed. Never install sprinklers that have been dropped, damaged, or exposed to temperatures exceeding the maximum ambient temperature allowed. Sprinklers that have been painted in the field must be replaced per NFPA 13. Protect sprinklers from paint and paint overspray in accordance with the installation standards. Do not clean sprinklers with soap and water, ammonia, or any other cleaning fluid. Do not use adhesives or solvents on sprinklers or their operating elements.

Refer to the appropriate technical data page and NFPA standards for complete care, handling, installation, and maintenance instructions. For additional product and system information Viking data pages and installation instructions are available on the Viking Web site at www.vikinggroupinc.com.



BULLETIN

CARE AND HANDLING
OF SPRINKLERS

The Viking Corporation, 210 N Industrial Park Drive, Hastings MI 49058
 Telephone: 269-945-9501 Technical Services: 877-384-5464 Fax: 269-818-1680 Email: techsvcs@vikingcorp.com

PROTECTIVE SPRINKLER SHIELDS AND CAPS

General Handling and Storage:

Many Viking sprinklers are available with a plastic protective cap or shield temporarily covering the operating elements. The snap-on shields and caps are factory installed and are intended to help protect the operating elements from mechanical damage during shipping, storage, and installation. NOTE: It is still necessary to follow the care and handling instructions on the appropriate sprinkler technical data sheets* when installing sprinklers with bulb shields or caps.

WHEN TO REMOVE THE SHIELDS AND CAPS:

NOTE: SHIELDS AND CAPS MUST BE REMOVED FROM SPRINKLERS BEFORE PLACING THE SYSTEM IN SERVICE!

Remove the shield or cap from the sprinkler only after checking all of the following:

- The sprinkler has been installed*.
- The wall or ceiling finish work is completed where the sprinkler is installed and there no longer is a potential for mechanical damage to the sprinkler operating elements.

SHIELDS AND CAPS MUST BE REMOVED FROM SPRINKLERS BEFORE PLACING THE SYSTEM IN SERVICE!



Figure 1: Sprinkler shield being removed from a pendent sprinkler.



Figure 2: Sprinkler cap being removed from a pendent sprinkler.



Figure 3: Sprinkler cap being removed from an upright sprinkler.

HOW TO REMOVE SHIELDS AND CAPS:

No tools are necessary to remove the shields or caps from sprinklers. DO NOT use any sharp objects to remove them! **Take care not to cause mechanical damage to sprinklers when removing the shields or caps.** When removing caps from fusible element sprinklers, use care to prevent dislodging ejector springs or damaging fusible elements. NOTE: Squeezing the sprinkler cap excessively could damage sprinkler fusible elements.

- To remove the shield, simply pull the ends of the shield apart where it is snapped together. Refer to Figure 1.
- To remove the cap, turn it slightly and pull it off the sprinkler. Refer to Figures 2 and 3.

NOTICE

Refer to the current sprinkler technical data page to determine the correct sprinkler wrench for the model of sprinkler used.

WARNING

Never install sprinklers that have been dropped, damaged, or exposed to temperatures in excess of the maximum ambient temperature allowed.

* Refer to the appropriate current technical data pages for complete care, handling, and installation instructions. Data pages are included with each shipment from Viking or Viking distributors. They can also be found on the Web site at www.vikinggroupinc.com.



BULLETIN

CARE AND HANDLING
OF SPRINKLERS

The Viking Corporation, 210 N Industrial Park Drive, Hastings MI 49058
 Telephone: 269-945-9501 Technical Services: 877-384-5464 Fax: 269-818-1680 Email: techsvcs@vikingcorp.com



CONCEALED COVER ASSEMBLIES ARE FRAGILE!
TO ASSURE SATISFACTORY PERFORMANCE OF THE PRODUCT, HANDLE WITH CARE.



Concealed Sprinkler and Adapter
 Assembly with Protective Cap

Concealed Sprinkler and Adapter
 Assembly (Protective Cap Removed)



Cover Plate Assembly
 (Pendent Cover 12381 shown)



GENERAL HANDLING AND STORAGE INSTRUCTIONS:

- Do not store in temperatures exceeding 100 °F (38 °C). Avoid direct sunlight and confined areas subject to heat.
- Protect sprinklers and cover assemblies during storage, transport, handling, and after installation.
 - Use original shipping containers.
 - Do not place sprinklers or cover assemblies loose in boxes, bins, or buckets.
- Keep the sprinkler bodies covered with the protective sprinkler cap any time the sprinklers are shipped or handled, during testing of the system, and while ceiling finish work is being completed.
- Use only the designated Viking recessed sprinkler wrench (refer to the appropriate sprinkler data page) to install these sprinklers. **NOTE:** The protective cap is temporarily removed during installation and then placed back on the sprinkler for protection until finish work is completed.
- Do not over-tighten the sprinklers into fittings during installation.
- Do not use the sprinkler deflector to start or thread the sprinklers into fittings during installation.
- Do not attempt to remove drywall, paint, etc., from the sprinklers.
- Remove the plastic protective cap from the sprinkler before attaching the cover plate assembly. **PROTECTIVE CAPS MUST BE REMOVED FROM SPRINKLERS BEFORE PLACING THE SYSTEM IN SERVICE!**

Refer to the appropriate current technical data pages for complete care, handling, and installation instructions. Data pages are included with each shipment from Viking or Viking distributors. They can also be found on the Web site at www.vikinggroupinc.com.



BULLETIN

CARE AND HANDLING
OF SPRINKLERS

The Viking Corporation, 210 N Industrial Park Drive, Hastings MI 49058

Telephone: 269-945-9501 Technical Services: 877-384-5464 Fax: 269-818-1680 Email: techsvcs@vikingcorp.com

USE THE FOLLOWING PRECAUTIONS WHEN HANDLING WAX-COATED SPRINKLERS

Many of Viking's sprinklers are available with factory-applied wax coating for corrosion resistance. These sprinklers MUST receive appropriate care and handling to avoid damaging the wax coating and to assure satisfactory performance of the product.

General Handling and Storage of Wax-Coated Sprinklers:

- Store the sprinklers in a cool, dry place (in temperatures below the maximum ambient temperature allowed for the sprinkler temperature rating. Refer to Table 1 below.)
- Store containers of wax-coated sprinklers separate from other sprinklers.
- Protect the sprinklers during storage, transport, handling, and after installation.
- Use original shipping containers.
- Do not place sprinklers in loose boxes, bins, or buckets.

Installation of Wax-Coated Sprinklers:

Use only the special sprinkler head wrench designed for installing wax-coated Viking sprinklers (any other wrench may damage the unit).

- Take care not to crack the wax coating on the units.
- For touching up the wax coating after installation, wax is available from Viking in bar form. Refer to Table 1 below. The coating MUST be repaired after sprinkler installation to protect the corrosion-resistant properties of the sprinkler.
- Use care when locating sprinklers near fixtures that can generate heat. Do not install sprinklers where they would be exposed to temperatures exceeding the maximum recommended ambient temperature for the temperature rating used.
- Inspect the coated sprinklers frequently soon after installation to verify the integrity of the corrosion resistant coating. Thereafter, inspect representative samples of the coated sprinklers in accordance with NFPA 25. Close up visual inspections are necessary to determine whether the sprinklers are being affected by corrosive conditions.

TABLE 1

Sprinkler Temperature Rating (Fusing Point)	Wax Part Number	Wax Melting Point	Maximum Ambient Ceiling Temperature ¹	Wax Color
155 °F (68 °C) / 165 °F (74 °C)	02568A	148 °F (64 °C)	100 °F (38 °C)	Light Brown
175 °F (79 °C)	04146A	161 °F (71 °C)	150 °F (65 °C)	Brown
200 °F (93 °C)	04146A	161 °F (71 °C)	150 °F (65 °C)	Brown
220 °F (104 °C)	02569A	170 °F (76 °C)	150 °F (65 °C)	Dark Brown
286 °F (141 °C)	02569A	170 °F (76 °C)	150 °F (65 °C)	Dark Brown

¹ Based on NFPA-13. Other limits may apply, depending on fire loading, sprinkler location, and other requirements of the Authority Having Jurisdiction. Refer to specific installation standards.



Never install sprinklers that have been dropped, damaged, or exposed to temperatures in excess of the maximum ambient temperature allowed.

Refer to the appropriate current technical data pages for complete care, handling, and installation instructions. Data pages are included with each shipment from Viking or Viking distributors. They can also be found on the Web site at www.vikinggroupinc.com.



TECHNICAL DATA

SPRINKLER GENERAL CARE, INSTALLATION, AND MAINTENANCE GUIDE

The Viking Corporation, 210 N Industrial Park Drive, Hastings MI 49058

Telephone: 269-945-9501 Technical Services: 877-384-5464 Fax: 269-818-1680 Email: techsvcs@vikingcorp.com

Visit the Viking website for the latest edition of this technical data page.

1. DESCRIPTION - STANDARD RESPONSE, QUICK RESPONSE, EXTENDED COVERAGE, AND DRY SPRINKLERS

Viking thermosensitive spray sprinklers consist of a small frame and either a glass bulb or a fusible operating element. Available styles include pendent, flush pendent, concealed pendent, upright, horizontal sidewall, vertical sidewall, or conventional, depending on the particular sprinkler model selected.

Viking sprinklers are available with various finishes, temperature ratings, responses, and K-Factors to meet design requirements†. Used in conjunction with one of the corrosion-resistant coatings (for frame style sprinklers), the units provide protection against many corrosive environments. In addition, the special Polyester or Teflon® coatings can be used in decorative applications where colors are desired.

† Refer to the sprinkler technical data page for available styles, finishes, temperature ratings, responses, and nominal K-Factors for specific sprinkler models.

2. LISTINGS AND APPROVALS

Refer to the Approval Charts on the appropriate sprinkler technical data page(s) and/or approval agency listings.

3. TECHNICAL DATA

Specifications:

Refer to the appropriate sprinkler technical data sheet.

Material Standards:

Refer to the appropriate sprinkler technical data sheet.

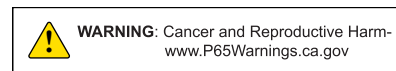

4. INSTALLATION

NOTE: Take care not to over-tighten the sprinkler and/or damage its operating parts!

Maximum Torque:

1/2" NPT: 14 ft-lbs. (19.0 N-m)

3/4" NPT: 20 ft-lbs. (27.1 N-m)

1" NPT: 30 ft-lbs. (40.7 N-m)

A. Care and Handling (also refer to Bulletin - Care and Handling of Sprinklers, Form No. F_091699.)

Sprinklers must be handled with care. They must be stored in a cool, dry place in their original shipping container. Never install sprinklers that have been dropped, damaged, or exposed to temperatures exceeding the maximum ambient temperature allowed (refer to the temperature chart on the sprinkler technical data page). Never install any glass-bulb sprinkler if the bulb is cracked or if there is a loss of liquid from the bulb. A small air bubble should be present in the glass bulb. Any sprinkler with a loss of liquid from the glass bulb or damage to the fusible element should be destroyed immediately. (Note: Installing glass bulb sprinklers in direct sunlight (ultraviolet light) may affect the color of the dye used to color code the bulb. This color change does not affect the integrity of the bulb.)

Sprinklers must be protected from mechanical damage during storage, transport, handling, and after installation. Sprinklers subject to mechanical damage must be protected with an approved sprinkler guard.

Use only sprinklers listed as corrosion resistant when subject to corrosive environments. When installing corrosion-resistant sprinklers, take care not to damage the corrosion-resistant coating. Use only the special wrench designed for installing coated or recessed Viking sprinklers (any other wrench may damage the unit).

Concealed sprinklers must be installed in neutral or negative pressure plenums only!

Use care when locating sprinklers near fixtures that can generate heat. Do not install sprinklers where they could be exposed to temperatures exceeding the maximum recommended ambient temperature for the temperature rating used.

Wet pipe systems must be provided with adequate heat. Sprinklers supplied from dry systems in areas subject to freezing must be listed dry sprinklers, upright, or horizontal sidewall sprinklers installed so that water is not trapped. For dry systems, pendent sprinklers and sidewall sprinklers installed on return bends are permitted, where the sprinklers, return bend, and branch line piping are in an area maintained at or above 40 °F (4 °C).

B. Installation Instructions - Standard Spray Sprinklers

Viking sprinklers are manufactured and tested to meet the rigid requirements of approving agencies. They are designed to be installed in accordance with recognized installation standards. Deviation from the standards or any alteration to sprinklers or cover plate assemblies after they leave the factory including, but not limited to: painting, plating, coating, or modification, may render them inoperative and will automatically nullify the approvals and any guarantee made by The Viking Corporation.



TECHNICAL DATA

SPRINKLER GENERAL CARE, INSTALLATION, AND MAINTENANCE GUIDE

The Viking Corporation, 210 N Industrial Park Drive, Hastings MI 49058

Telephone: 269-945-9501 Technical Services: 877-384-5464 Fax: 269-818-1680 Email: techsvcs@vikingcorp.com

Visit the Viking website for the latest edition of this technical data page.

Before installation, be sure to have the appropriate sprinkler model and style, with the correct K-Factor, temperature rating, and response characteristics. Sprinklers must be installed after the piping is in place to prevent mechanical damage. Keep sprinklers with protective caps or bulb shields contained within the caps or shields during installation and testing, and any time the sprinkler is shipped or handled.

1a. For frame-style sprinklers, install escutcheon (if used), which is designed to thread onto the external threads of the sprinkler. Refer to the appropriate sprinkler data page to determine approved escutcheons for use with specific sprinkler models.

1b. For flush and concealed style sprinklers: Cut the sprinkler nipple so that the 1/2" or 3/4" (15 mm or 20 mm)* NPT outlet of the reducing coupling is at the desired location, and centered in the opening* in the ceiling or wall.

*Size depends on the sprinkler model used. Refer to the sprinkler technical data page.

2. Apply a small amount of pipe-joint compound or tape to the external threads of the sprinkler only, taking care not to allow a build-up of compound in the sprinkler inlet. **NOTE:** Sprinklers with protective caps or bulb shields must have the caps or shields kept on them when applying pipe-joint compound or tape. *Exception: For domed concealed sprinklers, remove the protective cap for installation, and then place it back on the sprinkler temporarily.*

3. Refer to the appropriate sprinkler technical data page to determine the correct sprinkler wrench for the model of sprinkler used. DO NOT use the deflector or fusible element to start or thread the sprinkler into a fitting.

a. Install the sprinkler onto the piping using the special sprinkler wrench only, taking care not to over-tighten or damage the sprinkler.

b. For flush and concealed style sprinklers: the internal diameter of the special sprinkler installation wrench is designed for use with the sprinkler contained in the protective cap. *Exception: For domed concealed sprinklers, remove the protective cap for installation, and then place it back on the sprinkler temporarily.* Thread the flush or concealed sprinkler into the 1/2" or 3/4" (15 mm or 20 mm)* NPT outlet of the coupling by turning it clockwise with the special sprinkler wrench. *Thread size depends on the particular sprinkler model used. Refer to the sprinkler technical data page.

C. Installation Instructions - Dry Sprinklers

WARNING: Viking dry sprinklers are to be installed in the 1" outlet (for dry and preaction systems), or run of malleable, ductile iron, or Nibco CPVC* threaded tee fittings (for wet systems) that meet the dimensional requirements of ANSI B16.3 (Class 150), or cast iron threaded tee fittings that meet the dimensional requirements of ANSI B16.4 (Class 125), even at branch line ends. The threaded end of the dry sprinkler is designed to allow the seal to penetrate and extend into the fitting to a predetermined depth. This prevents condensation from accumulating and freezing over the sprinkler seal. ***NOTE: When using CPVC fittings with Viking dry sprinklers, use only new Nibco Model 5012-S-BI. When selecting other CPVC fittings, contact Viking Technical Services.**

1. **DO NOT** install the dry sprinkler into a threaded elbow, coupling, or any other fitting that could interfere with thread penetration. Such installation would damage the brass seal.

2. **DO NOT** install dry sprinklers into couplings or fittings that would allow condensation to accumulate above the seal when the sprinkler is located in an area subject to freezing.

3. **NEVER** try to modify dry sprinklers. They are manufactured for specific "A" or "B" dimensions and cannot be modified.

The dry sprinkler must be installed after the piping is in place to prevent mechanical damage. Before installation, be sure to have the correct sprinkler model and style, with the appropriate "A" or "B" dimension(s), temperature rating, orifice size, and response characteristics. Keep sprinklers with protective caps or bulb shields contained within the caps or shields during installation and testing, and any time the sprinkler is shipped or handled. *Exception: For concealed and adjustable recessed dry sprinklers, the protective caps and shields are removed for installation.*

To install the dry sprinkler, refer to the instructions below and the appropriate sprinkler technical data page for illustrated instructions.

Dry upright sprinklers must be installed above the piping, in the upright position only. When installing dry upright or plain barrel style vertical sidewall sprinklers on piping located close to the ceiling, it may be necessary to lower the sprinkler into the fitting from above the ceiling. When installing dry upright or plain barrel vertical sidewall sprinklers from below the ceiling, verify that the opening in the ceiling is a minimum 1-1/2" (38.1 mm) in diameter.

For dry upright or plain barrel vertical sidewall sprinklers in the upright position: First, install the escutcheon (if used) over the threaded end of the sprinkler barrel. Slide the escutcheon past the external threads. NOTE: When installing the dry upright or plain barrel vertical sidewall sprinkler from above the ceiling, it will be necessary to install the escutcheon after lowering the threaded end of the sprinkler through the ceiling penetration.

A. **For all dry sprinklers:** Apply a small amount of pipe-joint compound or tape to the external threads of the sprinkler barrel only, taking care not to allow a build-up of compound or tape over the brass inlet and seal. **NOTE:** Sprinklers with protective caps or bulb shields must be contained within the caps or shields before applying pipe-joint compound or tape.



TECHNICAL DATA

SPRINKLER GENERAL CARE, INSTALLATION, AND MAINTENANCE GUIDE

The Viking Corporation, 210 N Industrial Park Drive, Hastings MI 49058

Telephone: 269-945-9501 Technical Services: 877-384-5464 Fax: 269-818-1680 Email: techsvcs@vikingcorp.com

Visit the Viking website for the latest edition of this technical data page.

- B. Refer to the appropriate sprinkler technical data page to determine the correct sprinkler wrench for the model of sprinkler used.
- C. Install the dry sprinkler on the piping using the special dry sprinkler wrench only, while taking care not to damage the sprinkler.
NOTE: Thread the sprinkler into the fitting hand tight, plus 1/2 turn with the dry sprinkler wrench.
- D. *For adjustable standard and adjustable recessed dry pendent and sidewall sprinklers: Escutcheons can be installed after the sprinklers have been installed onto the piping. Refer to the appropriate sprinkler technical data page for escutcheon installation instructions and illustrations.*

D. Installation Instructions - Testing

- 4. After installation, the entire sprinkler system must be tested. The test must be conducted to comply with the installation standards. Viking *high pressure* sprinklers may be hydrostatically tested at a maximum of 300 psi (20.7 bar) for limited periods of time (two hours), for the purpose of acceptance by the Authority Having Jurisdiction.
 - a. Make sure the sprinkler is properly tightened. If a thread leak occurs, normally the sprinkler must be removed, new pipe-joint compound or tape applied, and then reinstalled. This is due to the fact that when the joint seal is damaged, the sealing compound or tape is washed out of the joint. Air testing [do not exceed 40 psi (2.76 bar)] the sprinkler piping prior to testing with water may be considered in areas where leakage during testing must be prevented. Refer to the Installation Standards and the Authority Having Jurisdiction.
 - b. **Remove plastic protective sprinkler caps or bulb shields AFTER the wall or ceiling finish work is completed where the sprinkler is installed and there no longer is a potential for mechanical damage to the sprinkler operating elements.** To remove the bulb shields, simply pull the ends of the shields apart where they are snapped together. To remove caps from frame style sprinklers, turn the caps slightly and pull them off the sprinklers. **SPRINKLER CAPS OR BULB SHIELDS MUST BE REMOVED FROM SPRINKLERS BEFORE PLACING THE SYSTEM IN SERVICE!** Retain a protective cap or shield in the spare sprinkler cabinet.
- 5. For flush style sprinklers: the ceiling ring can now be installed onto the sprinkler body. Align the ceiling ring with the sprinkler body and thread or push it on (depends on sprinkler model) until the outer flange touches the surface of the ceiling. Note the maximum adjustment is 1/4" (6.35 mm). DO NOT MODIFY THE UNIT. If necessary, re-cut the sprinkler drop nipple as required.
- 6. For concealed sprinklers: the cover assembly can now be attached.
 - a. Remove the cover from the protective box, taking care not to damage the cover plate assembly.
 - b. Gently place the base of the cover plate assembly over the sprinkler protruding through the opening in the ceiling.
 - c. Push the cover plate assembly onto the sprinkler until the unfinished brass flange of the cover plate base (or the cover adapter, if used) touches the surface of the ceiling.
 - d. Refer to the applicable technical data sheet to determine the maximum adjustment available for concealed sprinklers. DO NOT MODIFY THE UNIT. If necessary, re-cut the sprinkler drop nipple.

NOTE: If it is necessary to remove the entire sprinkler unit, the system must be taken out of service. See section 6. INSPECTIONS, TESTS AND MAINTENANCE and follow all warnings and instructions.

5. OPERATION

Refer to the appropriate sprinkler technical data page(s). During fire conditions, the operating element fuses or shatters (depending on the type of sprinkler), releasing the pip cap and sealing assembly. Water flowing through the sprinkler orifice strikes the sprinkler deflector, forming a uniform spray pattern to extinguish or control the fire.

IMPORTANT: Always refer to Bulletin Form No. F_091699 - Care and Handling of Sprinklers. Viking sprinklers are to be installed in accordance with the latest edition of Viking technical data, the appropriate standards of NFPA, FM Global, LPCB, APSAD, VdS or other similar organizations, and also with the provisions of governmental codes, ordinances, and standards, whenever applicable. The sprinkler technical data page may contain installation requirements specific for the sprinkler model selected. The use of certain types of sprinklers may be limited due to occupancy and hazard. Refer to the Authority Having Jurisdiction prior to installation.



TECHNICAL DATA

SPRINKLER GENERAL CARE, INSTALLATION, AND MAINTENANCE GUIDE

The Viking Corporation, 210 N Industrial Park Drive, Hastings MI 49058

Telephone: 269-945-9501 Technical Services: 877-384-5464 Fax: 269-818-1680 Email: techsvcs@vikingcorp.com

Visit the Viking website for the latest edition of this technical data page.

6. INSPECTIONS, TESTS AND MAINTENANCE

NOTICE: Refer to NFPA 25 for Inspection, Testing and Maintenance requirements. **NOTICE:** The owner is responsible for having the fire-protection system and devices inspected, tested, and maintained in proper operating condition in accordance with this guide, and applicable NFPA standards. In addition, the Authority Having Jurisdiction may have additional maintenance, testing, and inspection requirements that must be followed.

- A. Sprinklers must be inspected on a regular basis for corrosion, mechanical damage, obstructions, paint, etc. Frequency of inspections may vary due to corrosive atmospheres, water supplies, and activity around the sprinkler unit.
- B. Sprinklers or cover plate assemblies that have been field painted, caulked, or mechanically damaged must be replaced immediately. Sprinklers showing signs of corrosion shall be tested and/or replaced immediately as required. Installation standards require sprinklers to be tested and, if necessary, replaced after a specified term of service. Refer to NFPA 25 and the Authority Having Jurisdiction for the specified period of time after which testing and/or replacement is required. Never attempt to repair or reassemble a sprinkler. Sprinklers and cover assemblies that have operated cannot be reassembled or re-used, but must be replaced. When replacement is necessary, use only new sprinklers and cover assemblies with identical performance characteristics.
- C. The sprinkler discharge pattern is critical for proper fire protection. Therefore, nothing should be hung from, attached to, or otherwise obstruct the discharge pattern. All obstructions must be immediately removed or, if necessary, additional sprinklers installed.
- D. When replacing existing sprinklers, the system must be removed from service. Refer to the appropriate system description and/or valve instructions. Prior to removing the system from service, notify all Authorities Having Jurisdiction. Consideration should be given to employment of a fire patrol in the affected area.
 1. Remove the system from service, drain all water, and relieve all pressure on the piping.
 - 2a. For frame-style sprinklers, use the special sprinkler wrench to remove the old sprinkler by turning it counterclockwise to unthread it from the piping.
 - 2b. For flush and concealed style sprinklers: Remove the ceiling ring or cover plate assembly before unthreading the sprinkler body from the piping. Ceiling rings and cover plates can be removed either by gently unthreading them or pulling them off the sprinkler body (depends on the sprinkler model used). After the ceiling ring or cover plate assembly has been removed from the sprinkler body, place the plastic protective cap (from the spare sprinkler cabinet) over the sprinkler to be removed and then fit the sprinkler wrench over the cap. Then use the wrench to unthread the sprinkler from the piping. *Exception: Domed concealed sprinklers are removed without the plastic cap.*
 3. Install the new sprinkler unit by following the instructions in section 4. INSTALLATION. Care must be taken to ensure that the replacement sprinkler is the proper model and style, with the correct K-Factor, temperature rating, and response characteristics. A fully stocked spare sprinkler cabinet should be provided for this purpose. For flush or concealed sprinklers: stock of spare ceiling rings or cover plates should also be available in the spare sprinkler cabinet.
- E. Place the system back in service and secure all valves. Check for and repair all leaks. Sprinkler systems that have been subjected to a fire must be returned to service as soon as possible. The entire system must be inspected for damage, and repaired or replaced as necessary. Sprinklers that have been exposed to corrosive products of combustion or high ambient temperatures, but have not operated, should be replaced. Refer to the Authority Having Jurisdiction for minimum replacement requirements.

7. AVAILABILITY

Viking sprinklers are available through a network of domestic and international distributors. See The Viking Corporation web site for the closest distributor or contact The Viking Corporation.

8. GUARANTEE

For details of warranty, refer to Viking's current list price schedule or contact Viking directly.

**BULLETIN****REGULATORY AND HEALTH
WARNINGS**

The Viking Corporation, 210 N Industrial Park Drive, Hastings MI 49058

Telephone: 269-945-9501 Technical Services: 877-384-5464 Fax: 269-818-1680 Email: techsvcs@vikingcorp.com

Visit the Viking website for the latest edition of this technical data page www.vikinggroupinc.com

1. DESCRIPTION

Regulatory and Health Warnings applying to materials used in the manufacture and construction of fire protection products are provided herein as they relate to legally mandated jurisdictional regions.

⚠ WARNING**STATE OF CALIFORNIA, USA**

Installing or servicing fire protection products such as sprinklers, valves, piping etc. can expose you to chemicals including, but not limited to, lead, nickel, butadiene, titanium dioxide, chromium, carbon black, and acrylonitrile which are known to the State of California to cause cancer or birth defects or other reproductive harm.

For more information, go to www.P65Warnings.ca.gov

2. WARRANTY TERMS AND CONDITIONS

For details of warranty, refer to Viking's current list price schedule at www.vikinggroupinc.com or contact Viking directly.