



## TECHNICAL DATA SHEET

## MODEL EA-1 ELECTRONIC ACCELERATOR

### 1. PRODUCT IDENTIFICATION

This document covers the following product, hereafter referred to as "EA-1":

Model EA-1 Electronic Accelerator.

**Part Number (EA-1 ONLY): 27327**

Refer to section 7 for other options and configurations.

### 2. DESCRIPTIONS AND INTENDED USE

The accelerator is a quick-opening device designed for use with select Viking Double Interlock Preaction Systems with Electric/Pneu-Lectric Release and select Dry Pipe Systems. The accelerator speeds up the system valve operation by monitoring air/nitrogen pressure twice per second. The accelerator must have a solenoid valve and the EA-1 (which also serves as the air supervisory switch) to function properly. Refer to the following descriptions for further details.

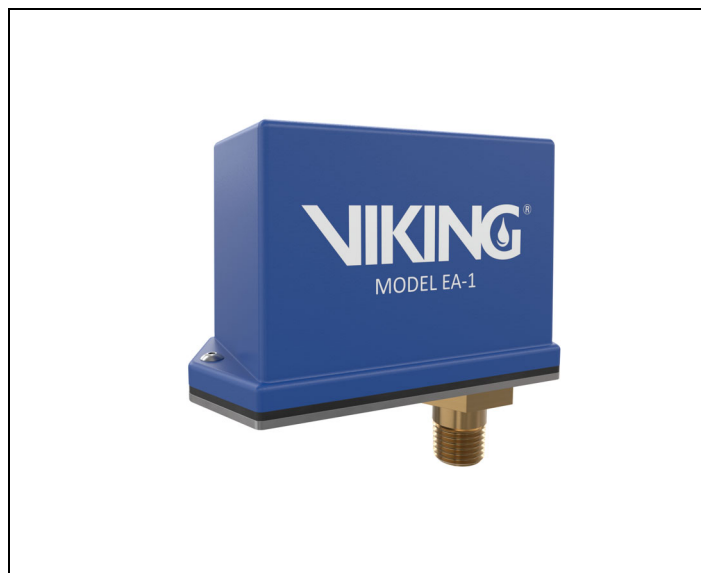

#### 2.1 Double Interlock Preaction Systems

The accelerator is designed to be used with two system risers on Double Interlock Preaction Systems with Electric/Pneu-Lectric Release. It is approved for use with the Viking Model VXD Deluge Valve, the Model F Deluge Valve (used on a Double Interlock Preaction system with Electric/Pneu-Lectric Release), and the VFR-500 Release Control Panel.

#### 2.2 Dry Pipe Systems

The Viking Model EA-1 is designed to be used with the following:

- The Viking Model VXR Dry Valve.
- The Viking Model F Dry Valve.
- Up to four EA-1 switches on dry pipe system risers, plus one VFR-500 Release Control Panel.

#### 2.3 Accelerator Features

- The accelerator operates the preaction or dry pipe system within four seconds.
- It is used with a VFR-500 Release Control Panel that has up to two Double Interlock Preaction Systems with Electric/Pneu-Lectric Release or four dry pipe systems. For more details on the VFR-500 Release Control Panel, see the VFR-500 technical data sheet F\_081022.
- It contains a low- and high-pressure supervisory alarm.

#### 2.4 Accelerator Functional Description

The accelerator monitors the air/nitrogen pressure by using an internal pressure transducer that samples air/nitrogen pressure twice per second. If the accelerator detects a severe drop in air/nitrogen pressure (greater than 0.1 PSI (0.007 bar) per second) after taking three consecutive air/nitrogen samples, it will signal the VFR-500 Release Control Panel.



### 3. SYSTEM OPERATION

#### 3.1 Double Interlock Preaction System Operation

When the detection system activates the VFR-500 Release Control Panel's first initiating circuit, it sets off the alarm. Then, when a sprinkler is activated, the accelerator determines the drop in air/nitrogen pressure while taking three consecutive samples. If the pressure drops at a rate of 0.1 PSI (0.007 bar) per second, the accelerator activates the control panel's second initiating circuit.

Once both circuits have been activated, the VFR-500 Release Control Panel energizes and opens the solenoid valve.

#### 3.2 Dry Pipe System Operation

When a sprinkler activates, the accelerator will gauge the drop in air/nitrogen pressure while taking three consecutive samples. If the pressure drops at a rate of 0.1 PSI (0.007 bar) per second, the accelerator will activate.

On a Viking Model VXR Dry Valve System or a Viking Model F Dry Valve System, the accelerator's solenoid outlet air pressure is directed to the Viking Model VXR Dry Valve's or Viking Model F Dry Valve's intermediate chamber. As the air pressure increases in the dry valve's intermediate chamber, the pressure differential is overcome. The dry valve is then activated, allowing water to enter the system.

Governmental codes, ordinances, and standards may apply and may differ from one another.

#### **NOTICE**

**The accelerator must be installed and maintained in accordance with the information, instructions, and/or standards in this document, and in accordance with NFPA, FM, or any other Authorities Having Jurisdiction (AHJs). Failure to comply may impair this device's operation.**

#### **⚠ WARNING**

**The owner is responsible for maintaining the fire protection system and devices in proper operating condition. Refer to the installing contractor or the manufacturer for questions.**

#### **NOTICE**

**The accelerator uses electronic components to monitor system air/nitrogen pressure. Radio transmitters or RF sources must be kept at least one foot from the accelerator at all times. Additionally, shielded wire may be used to protect against accidental system activation. Failure to comply to these specifications could cause unintentional system activation.**



## 4. LISTING AND APPROVALS



### FM Approved

The accelerator is FM Approved for a maximum wwp of 250 PSI (17 bar).



### cULus Listed

The accelerator is UL Listed per UL1486 for a maximum system capacity of 2,250 gal (8517 L) and a maximum wwp of 250 PSI (17 bar).

## NOTICE

The accelerator's activation does not guarantee that water delivery time requirements will be met for the AHJ. The water delivery time is primarily determined by the piping network's configuration and volume, the system's air/nitrogen pressure when the accelerator activates, the number of sprinklers available and their orifice size(s), and the characteristics of the water supply. The system designer must be aware of typical delivery time calculation parameters and procedures in order to properly perform the task.

When a double interlock preaction system is installed, water delivery is based on the electric detection system operating before the first sprinkler.

### 4.1 Preaction System Compatibility

The accelerator is FM Approved to be used with the following Viking Preaction Systems.

- Model VXD Double Interlock Preaction System with Electric/Pneu-Lectric Release valves: 4", 6", 8", and, in loose trim, 10"
- Viking Model F Double Interlock Preaction System with Electric/Pneu-Lectric Release: 4", 6", 8"

For more details, refer to Section 3.1 above.

### 4.2 Dry Pipe Valve Compatibility

The accelerator is FM Approved for the following Viking Dry Pipe Systems.

- Viking Model VXR Dry Valve System: 4" and 6"
- Viking Model F Dry Valve System: 4" and 6"

For more details on how the accelerator functions with the Viking Model VXR Dry Valve System or the Viking Model F Dry Valve System, refer to Section 3.2 above.

**TECHNICAL DATA SHEET**
**MODEL EA-1 ELECTRONIC  
ACCELERATOR**
**5. TECHNICAL SPECIFICATIONS**
**5.1 EA-1 Ratings and Physical Characteristics**

Parameter	Value
Maximum operating pressure	250 PSI (17 bar) wwp
Maximum rated air/nitrogen pressure	70 PSI (4.8 bar) wwp <sup>1</sup>
Pressure decay for activate rating	0.1 PSI/sec (0.007 bar)
Low/high pressure settings	See Section 5.2
Power requirements (standby)	68 mA at 24Vdc
Power requirement (maximum alarm)	85 mA
Contact ratings (alarm and high/low air)	5 mA at 24Vdc

<sup>1</sup>Refer to Section 8.3 for Model VXR pressure setting details.

**5.2 Rotary Switch Pressure Settings**

The following table shows the rotary switch air/nitrogen pressure settings, which are applicable for every EA-1 compatible system.

Rotary Switch Air/Nitrogen Pressure Settings			
Settings	Low Air Threshold PSI (bar)	Nominal Pressure PSI (bar)	High Air Threshold PSI (bar)
0	7 (0.5)	11.5 (0.8)	15 (1.0)
1	10 (0.7)	15 (1.0)	20 (1.4)
2	15 (1.0)	20 (1.4)	25 (1.7)
3	20 (1.4)	25 (1.7)	30 (2.1)
4	25 (1.7)	30 (2.1)	35 (2.4)
5	30 (2.1)	35 (2.4)	40 (2.8)
6	35 (2.4)	40 (2.8)	45 (3.1)
7	40 (2.8)	45 (3.1)	50 (3.4)
8	45 (3.1)	52.5 (3.6)	60 (4.1)
9	55 (3.8)	65 (4.5)	70 (4.8)

*±1 PSI (0.07 bar) or ±5% tolerance, depending on which is greater.*



TECHNICAL DATA SHEET

MODEL EA-1 ELECTRONIC ACCELERATOR

6. EA-1 INSTALLATION ON VFR-500

6.1 Installation Standards

Refer to current Viking technical data describing the components and installation standards for individual Viking Double Interlock Preaction Systems with Electric/Pneu-Lectric Release, Viking Model F Double Interlock Preaction System with Electric/Pneu-Lectric Release Systems, Viking Model VXR Dry Valve Systems, or Viking Model F Dry Valve Systems. Also, refer to applicable installation standards, codes, and local jurisdictional requirements.

6.2 Accelerator Installation on a Preaction System

Program 3

CoilKeeper

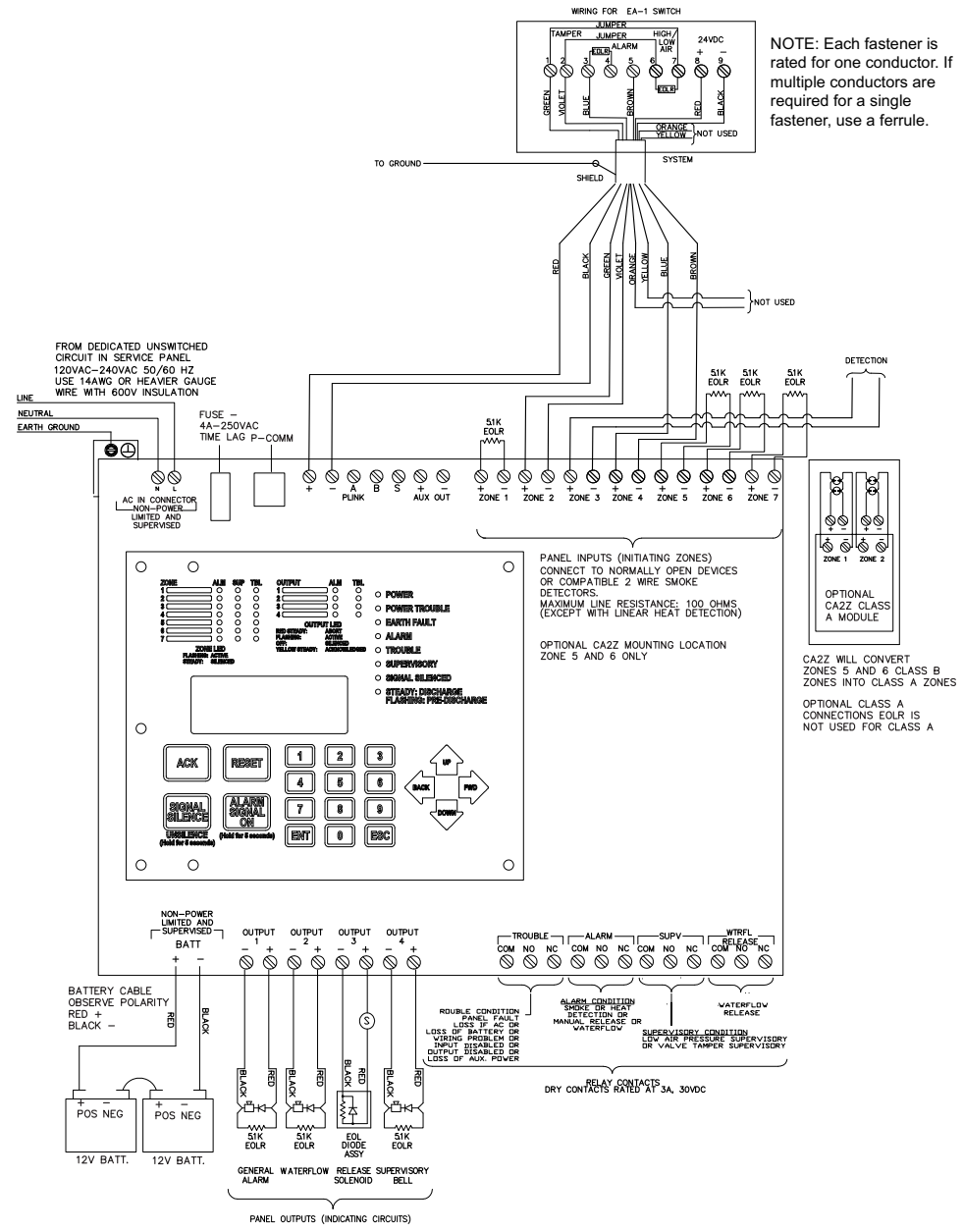
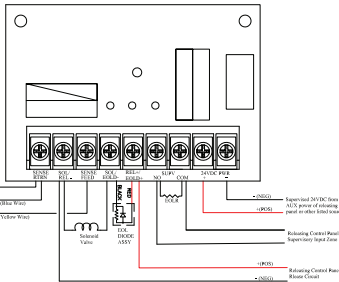

Figure – 1: Preaction System Wiring between Accelerator and VFR-500



TECHNICAL DATA SHEET

MODEL EA-1 ELECTRONIC ACCELERATOR

6.3 Accelerator Installation on a Dry Pipe System

Program 28

CoilKeeper

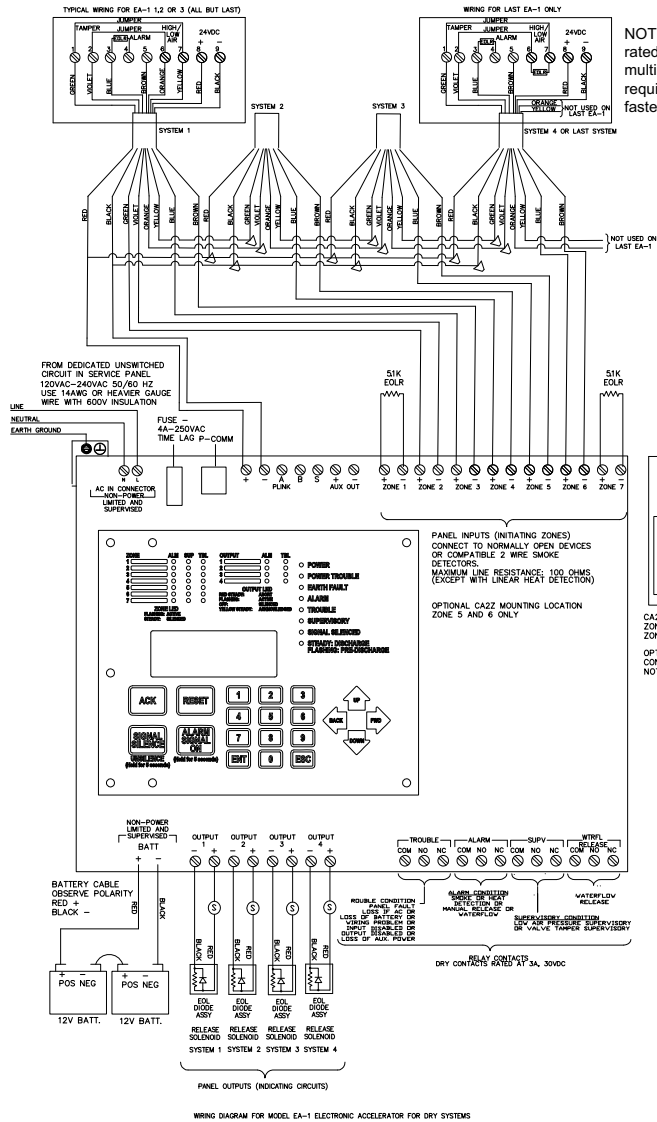
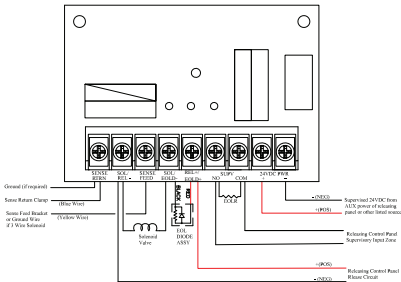

Figure – 2: Dry Pipe System Wiring Between Accelerator and VFR-500

6.4 EA-1 Programming Instructions

To seat/reset the VFR-500 Release Control Panel, do the following:

- Press the Reset button on the VFR-500.
- Press the ENT panel button.
- Enter 6 or scroll down to PROGRAMMING. Then, press the ENT button.
- Enter the password. Factory default password is 1111.
- Press 1 or ENT to select PROGRAM NUMBER. Enter program number 3 for a preaction system. Enter program number 28 for a dry pipe system.

**TECHNICAL DATA SHEET**
**MODEL EA-1 ELECTRONIC  
ACCELERATOR**
**7. ORDERING INFORMATION**
**7.1 EA-1 and CoilKeeper (Alone)**

**Figure – 3: EA-1 and CoilKeeper**

EA-1 and CoilKeeper For use with Viking Model F Double Interlock Preaction System with Electric/Pneu-Lectric Release (4", 6", and 8")	
System Type	Part Number
Model EA-1 Accelerator	27327
CoilKeeper	1010500

**TECHNICAL DATA SHEET**
**MODEL EA-1 ELECTRONIC  
ACCELERATOR**
**7.2 Model VXD Double Interlock Preaction System with Electric/Pneu-Lectric Release**

Figure – 4: Double Interlock Preaction System with Electric/Pneu-Lectric Release (4" Shown)

Model VXD Double Interlock Preaction System with Electric/Pneu-Lectric Release				
Type	Nominal Size	Part Number (with CoilKeeper)	Part Number (with monitored solenoid)	Trim Diagram
<p><b>Pre-trimmed Riser assemblies include the model VXD Deluge Valve, riser check valve, a releasing solenoid*, pressure switches, water supply control valve, grooved connections for installation, and the EA-1 all completely assembled and ready to install into the riser.</b></p> <p>*To meet NFPA requirements, pre-trimmed riser assemblies will include one of two different monitoring devices: the CoilKeeper, which is shipped loose and requires installation, OR the monitored solenoid. Systems with the CoilKeeper will have a non-monitored solenoid, while systems with a monitored solenoid will not include the CoilKeeper. Refer to the trim diagrams for detailed component information.</p>				
Galvanized Pretrimmed Riser (PTR)	4"	26680	28236	F_082624
	6"	26682	28237	F_082724
	8"	26684	28238	F_082824
<p><b>Loose trim packages DO NOT include the model VXD Deluge Valve, riser check valve, pressure switch(es), or water supply control valve. These packages include the Model EA-1 Accelerator with the CoilKeeper OR the monitored solenoid. Refer to the trim diagrams for detailed component information. Refer to the trim diagrams for detailed component information.</b></p>				
Galvanized Loose Trim	4"	27463-1	28241-1	F_083024
	6"	27465-1	28242-1	F_083124
	8"	27467-1	28243-1	F_090124
	10"	27469-1	28244-1	F_090224
Brass Loose Trim	4"	27463-2	28241-2	F_090324
	6"	27465-2	28242-2	F_090424
	8"	27467-2	28243-2	F_090524
	10"	27469-2	28244-2	F_090624



### 7.3 Model VXR Dry Pipe Systems

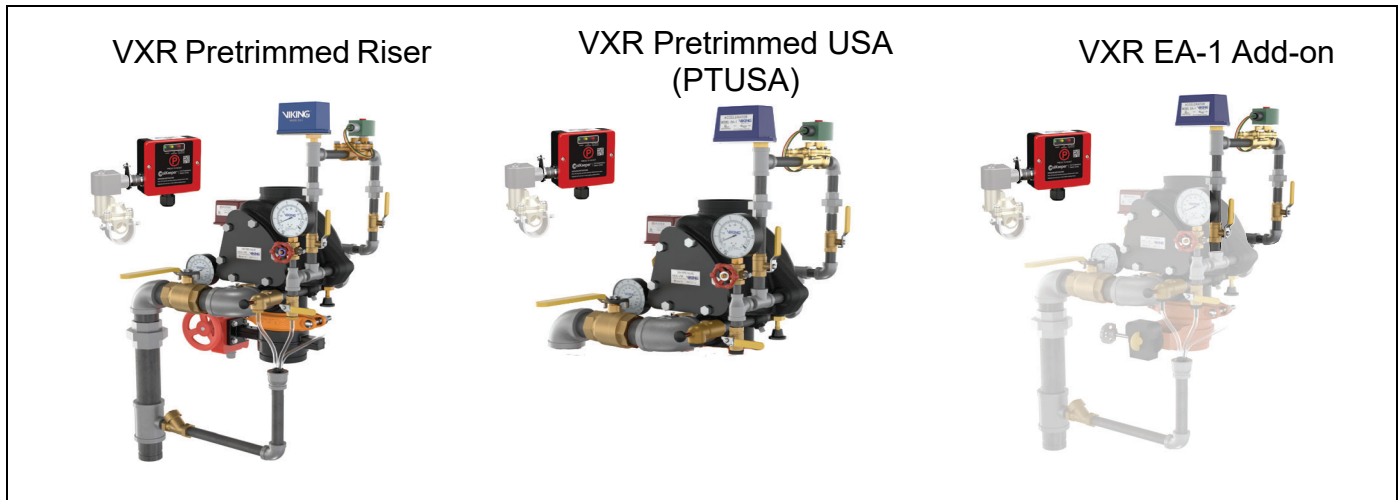

Figure – 5: 4" Model VXR Pre-Trimmed Riser and Pre-Trimmed with EA-1 and CoilKeeper

Model VXR Dry Pipe Systems				
Type	Nominal Size	Part Number (with CoilKeeper)	Part Number (with monitored solenoid)	Trim Diagram
<b>Pre-trimmed Riser (PTR) assemblies include the Model VXR Dry Valve, releasing solenoid*, the EA-1, and a water pressure switch all completely assembled and ready to install into the riser. All trim pipe and fittings are galvanized.</b>				
Pretrimmed Riser (PTR)	4"	27343	28245	F_090324
	6"	27345	28246	F_090424
<b>Pre-trimmed (PT) packages include the model VXR Dry Valve, releasing solenoid*, and the EA-1 all fully assembled and ready to install into the riser.</b>				
Pre-trimmed (PTUSA)	4"	27446-USA	28247-USA	F_091024
	6"	27455-USA	28251-USA	F_091124
<b>The add-on package includes the EA-1, the CoilKeeper*, and the required trim to install on a Model VXR Dry Pipe System. This package DOES NOT include the model VXR Dry Valve or trim, pressure switches, or water supply control valve. Refer to the trim diagrams for detailed component information.</b>				
EA-1/CoilKeeper (Add-on)	N/A	27439	28259	F_090724
		27439-USA	28259-USA	F_091224
<b>Footnote:</b>				
*To meet NFPA requirements, pre-trimmed riser and pre-trimmed assemblies, as well as loose trim, will include one of two different monitoring devices: the CoilKeeper, which is shipped loose and requires installation, OR the monitored solenoid. Systems with the CoilKeeper will have a non-monitored solenoid, while systems with a monitored solenoid will not include the CoilKeeper. Refer to the trim diagrams for detailed component information.				

### 7.4 Model F Dry Valve System with the EA-1 (Retrofit)

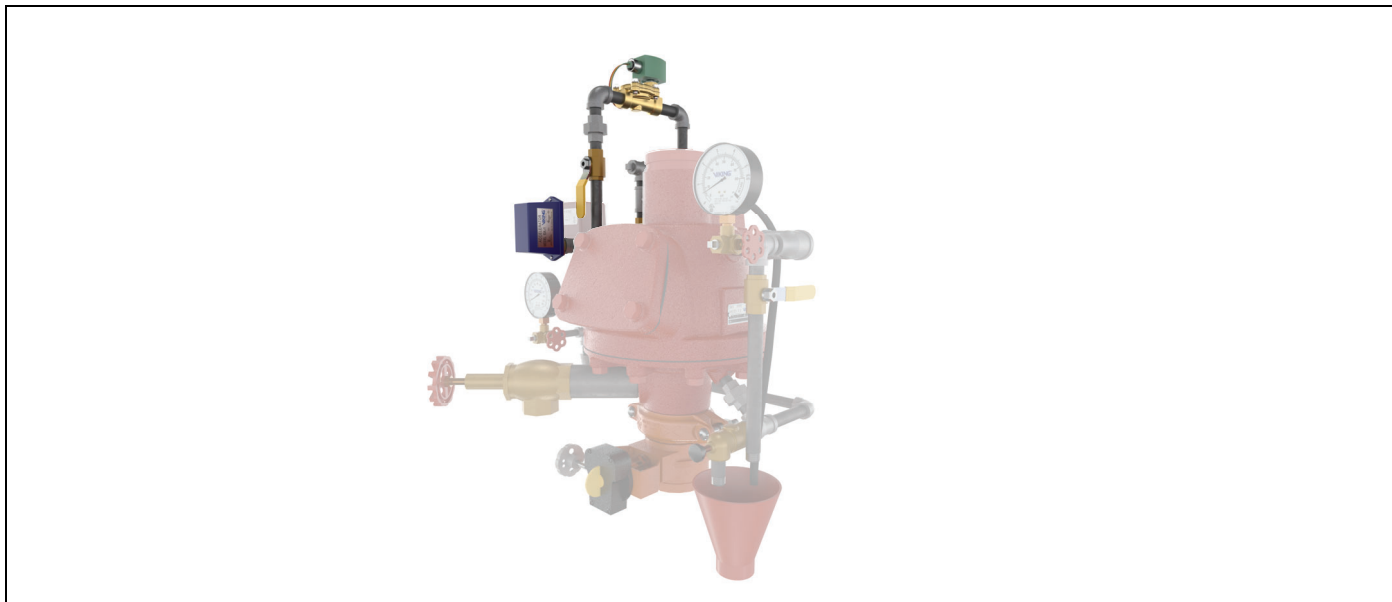

Figure – 6: Model F Dry Valve Trim Kit with EA-1

EA-1 Trim Kit for Model F Dry Pipe Systems (Retrofit only)			
Type	Nominal Size	Part Number	Trim Diagram
<p>This kit includes required trim components to install the EA-1 and CoilKeeper on an existing dry pipe system that uses the Model F Dry Valve.</p> <p><b>NOTE:</b> The VFR-500 Release Control Panel is required to control the EA-1 and CoilKeeper.</p>			
Model F Dry Pipe Valve	4"	26739	F_090824
	6"		

### 8. SYSTEM SETUP INSTRUCTIONS

#### 8.1 Model VXD Double Interlock Preaction System with Electric/Pneu-Lectric Release

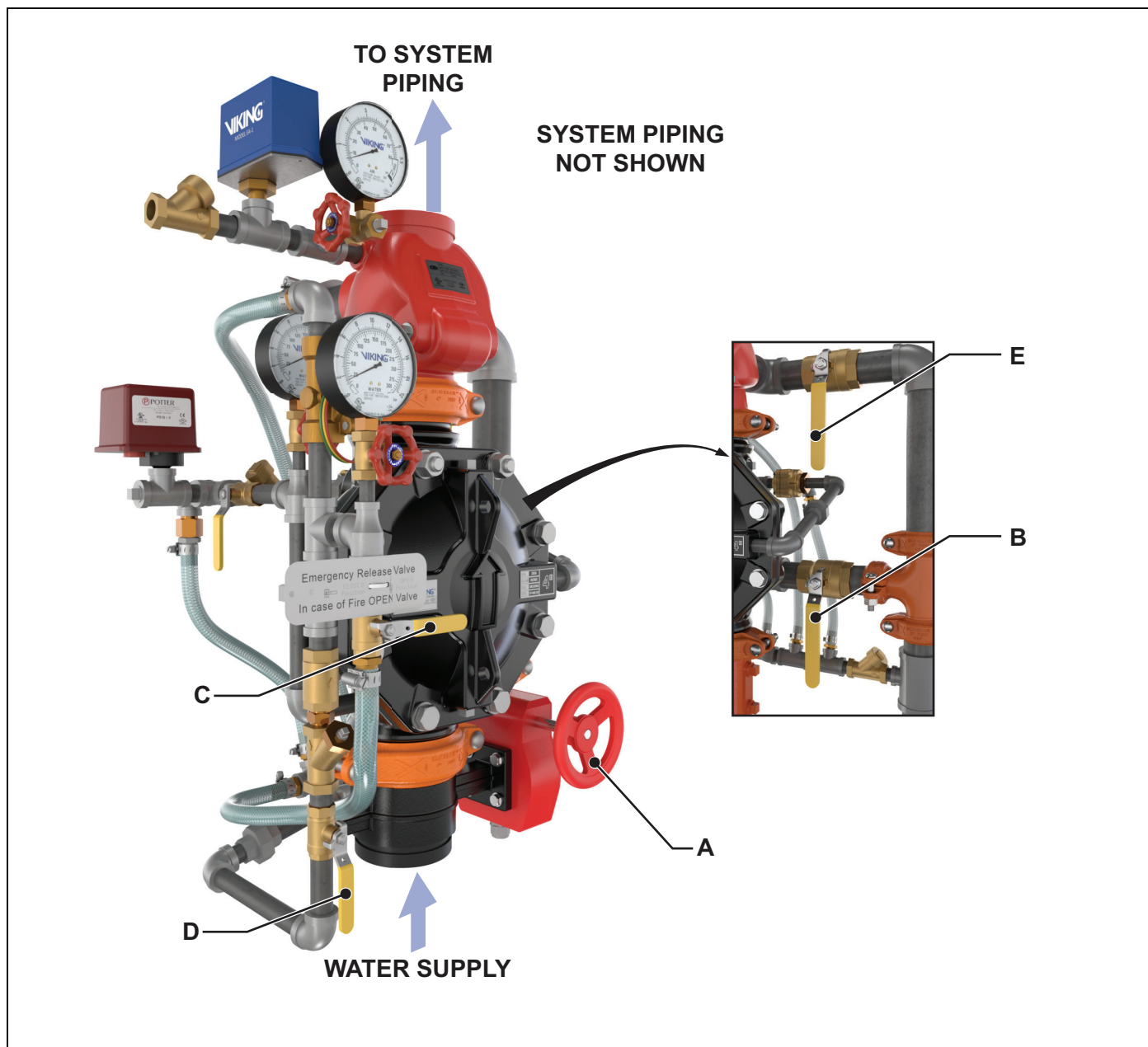

Figure – 7: VXD Preaction System with Electric/Pneu-Lectric Release

To place the Model VXD Double Interlock Preaction System with Electric/Pneu-Lectric Release (with the EA-1 and CoilKeeper) in service, follow the procedure below and refer to Figure 7 above.

### NOTICE

The system must be completely drained before proceeding.



**NOTE: If preferred, press the Signal Silence button on the VFR-500 Release Control Panel to silence all buzzer outputs until placing the system in service.**

1. Verify the following:
  - The main water supply control valve (A) is closed.
  - The system has been properly drained, and the main drain (E) is open.
  - The emergency release (C) is closed.
2. Close the system main drain.

**NOTE: For steps 3 and 4, refer to Section 6.2 above.**

3. Press the ENT button on the VFR-500 Release Control Panel to display the main menu.
4. Press 8 then enter the password. Factory default password is 1111.
5. Press 9 (FILL). The alarm inputs will be ignored so the system can be reset.
6. Restore the sprinkler piping's supervisory pressure. Verify that the 1/2" valve in the air/nitrogen maintenance device by-pass trim (not shown) is closed and that both the 1/4" valves are open.
7. Open the priming valve (D).
8. Open the flow test valve (B).
9. Slowly and partially open the main water supply control valve (A).

**NOTE: Opening the main water supply valve too quickly can create excessive pressure, causing the valve to open.**

10. When the flow test valve (B) discharges a full flow of water, close the valve. Verify that there is no water flow from the flow test valve.
11. Fully open and secure the main water supply control valve (A).
12. Verify that all valves are in their normal operating position.
13. Verify that no water is discharging into the drain cup.
14. Check for and repair all leaks.
15. For the following situations, activate the system to verify that its equipment functions properly:
  - After a new system has been installed
  - After the system was placed out of service
  - If a system has new equipment
16. After completing the system test, perform semi-annual maintenance.
17. After maintenance is performed, press the ESC button on the VFR-500 to place the panel back in service.

## CAUTION

**Performing an activation test results in operating the valve. Water will flow into the sprinkler piping, as a result. Take necessary precautions to prevent damage.**

### VXD Supervisory Alarm Low Air/Nitrogen Pressure Settings

Refer to current Viking technical data describing the Model VXD Double Interlock Preaction System with Electric/Pneu-Lectric Release's individual components. Also, refer to applicable installation standards, codes, and local jurisdictional requirements.

**NOTE: Installation standards may allow air/nitrogen pressures lower than those recommended in this document. When using lower-than-recommended air/nitrogen pressures, verify that the pressure level is compatible with the air/nitrogen regulation equipment and the air/nitrogen supervisory switches.**

For air/nitrogen supply installation:

- Use a compressor that will produce the required cubic feet per minute. (For more details, see the Viking technical datasheet F\_052220.)
- Ensure that the air/nitrogen supplies are clean, dry, and oil-free.
- Regulate and restrict the automatic air/nitrogen supplies, and ensure the supplies come from a continuous source.
- A Viking D-2 Air Maintenance Device should be installed on each system equipped with a tank-mounted compressor. (**NOTE: For compressors with a capacity less than 5.5 ft<sup>3</sup>/min at 10 PSI (0.7 bar), NFPA 13 does not require an air maintenance device. The use of an air maintenance device with riser-mounted compressors can lead to compressor “short cycling.” Viking always recommends using a tank-mounted compressor with air maintenance device.**)

**NOTE: The minimum recommended pressure setting is 10 PSI.**

See Section 5.2 for the appropriate rotary switch pressure settings.

## 8.2 Placing Viking Model F Double Interlock Preaction System with Electric/Pneu-Lectric Release in Service

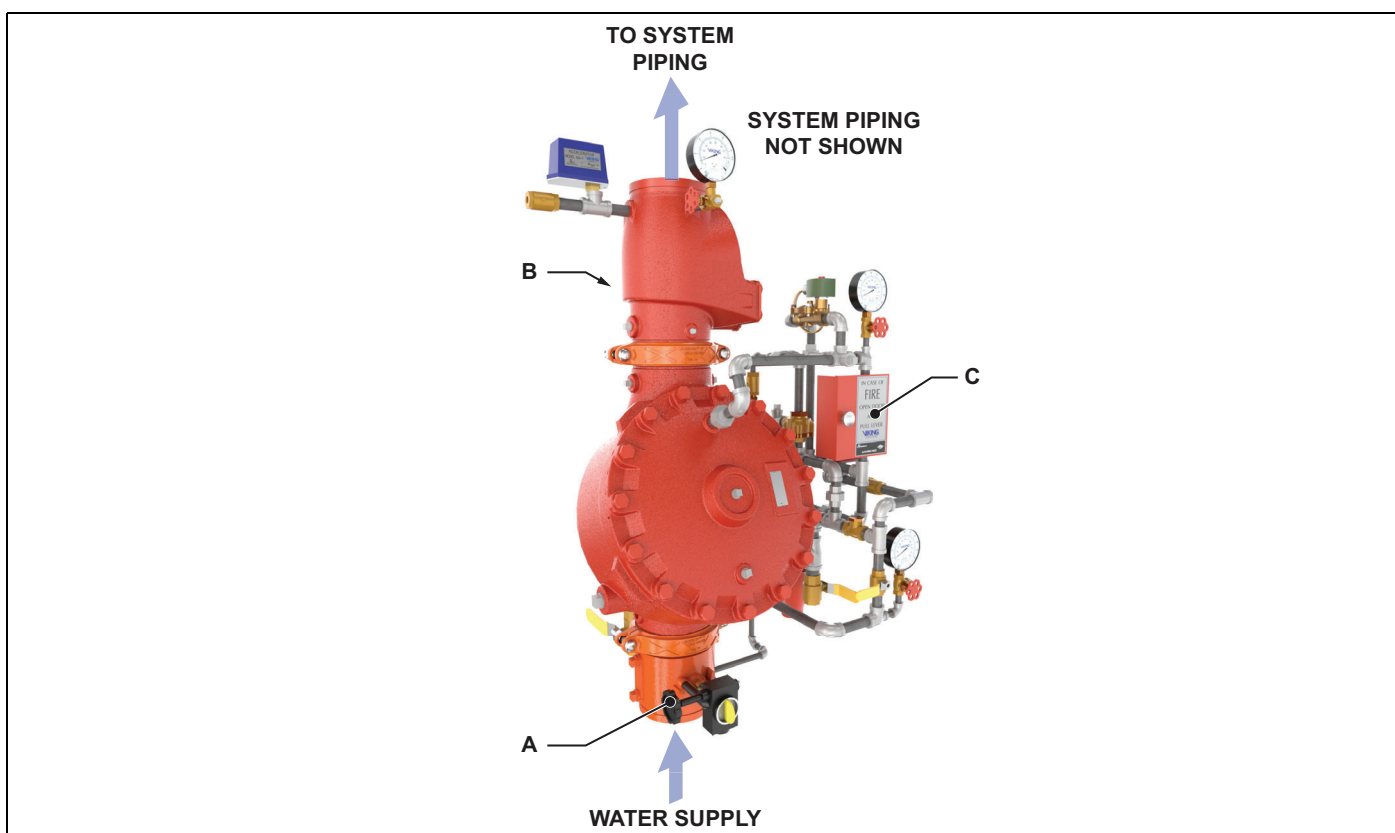

Figure – 8: Viking Model F Double Interlock Preaction System with Electric/Pneu-Lectric Release

To place the Viking Model F Double Interlock Preaction System with Electric/Pneu-Lectric Release in service, apply the following steps and refer to Figure 8 above:



## NOTICE

**The system must be completely drained before proceeding.**

**NOTE: If preferred, press the Signal Silence button on the VFR-500 Release Control Panel to silence all buzzer outputs until placing the system in service.**

1. Verify the following:
  - The system main water supply control valve (A) is closed.
  - The system has been properly drained, and the main drain (B-not shown) is open.
  - The emergency release (C) is closed.
2. Close the system main drain (B).
3. Press the Reset button on the VFR-500 Release Control Panel.
4. Press the ENT button on the VFR-500 Release Control Panel to display the main menu.
5. Press 8 then enter the password. Factory default password is 1111.
6. Press 9 (FILL). The alarm inputs will be ignored so the system can be reset.
7. Restore the sprinkler piping's supervisory pressure. Verify that the 1/2" valve in the air/nitrogen maintenance device by-pass trim is closed and that both the 1/4" valves are open.
8. Open the priming valve (not shown).
9. Open the flow test valve (not shown).
10. SLOWLY and PARTIALLY open the main water supply control valve (A).

**NOTE: Opening the main water supply valve too quickly can create excessive pressure, causing the valve to open.**

11. When the flow test valve discharges a full flow of water, close the valve. Verify that there is no water flow from the flow test valve.
12. Fully open and secure the main water supply control valve (A).
13. Verify that all valves are in their normal operating position.
14. Verify that no water is discharging into the drain cup.
15. Check for and repair all leaks.
16. For the following situations, activate the system to verify that its equipment functions properly:
  - After a new system has been installed.
  - After the system was placed out of service.
  - If a system has new equipment,
17. After completing the system test, perform semi-annual maintenance.
18. After maintenance is performed, press the ESC button on the VFR-500 to place the panel back in service.

## CAUTION

**Performing an activation test results in operating the valve. Water will flow into the sprinkler piping, as a result. Take necessary precautions to prevent damage.**

### Viking Model F Double Interlock Preaction System with Electric/Pneu-Lectric Release Supervisory Alarm Low Air/Nitrogen Pressure Settings

Refer to current Viking technical data describing the Viking Model F Double Interlock Preaction System with Electric/Pneu-Lectric Release Preaction System's individual components. Also, refer to applicable installation standards, codes, and local jurisdictional requirements.



***NOTE: Installation standards may allow air/nitrogen pressures lower than those recommended in this document. When using lower-than-recommended air/nitrogen pressures, verify that the pressure level is compatible with the air/nitrogen regulation equipment and the air/nitrogen supervisory switches.***

For air/nitrogen supply installation:

- Use a compressor that will produce the required cubic feet per minute. (For more details, see the Viking technical datasheet F\_020195.)
- Ensure that the air/nitrogen supplies are clean, dry, and oil-free.
- Regulate and restrict the automatic air/nitrogen supplies, and ensure the supplies come from a continuous source.
- A Viking D-2 Air Maintenance Device should be installed on each system equipped with a tank-mounted compressor. (***NOTE: For compressors with a capacity less than 5.5 ft<sup>3</sup>/min at 10 PSI (0.7 bar), NFPA 13 does not require an air maintenance device. The use of an air maintenance device with riser-mounted compressors can lead to compressor “short cycling.” It is recommended to use a tank-mounted compressor with air maintenance device.***)

***NOTE: The minimum recommended pressure setting is 10 PSI.***

See Section 5.2 for the appropriate rotary switch pressure settings.

### 8.3 Placing the Viking Model VXR Dry Valve System in Service

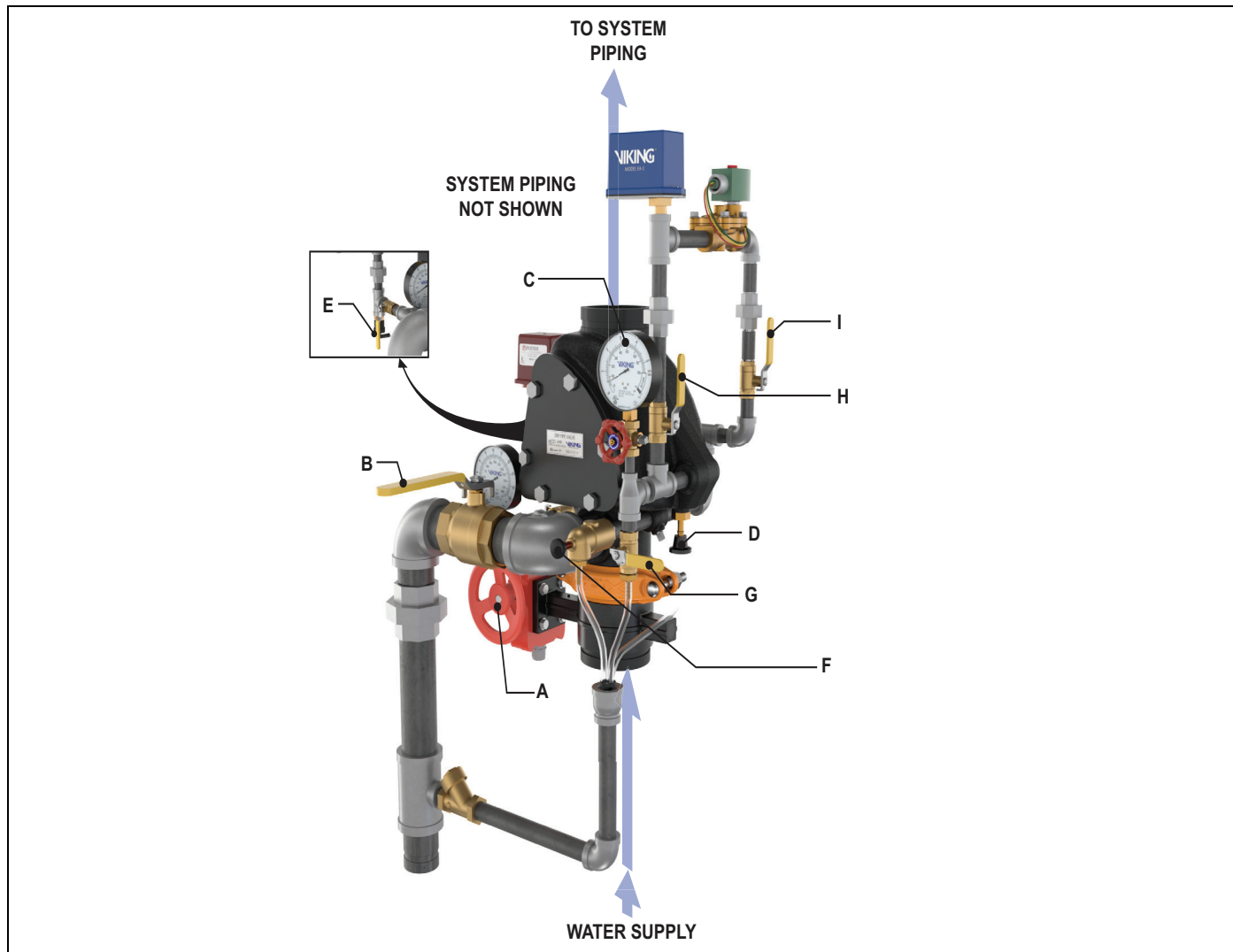

Figure – 9: VXR Dry Pipe System in Service

Ref	Description (N.O. = Normally Open, N.C. = Normally Closed)
A	Water supply control valve, N.O.
B	Main drain valve, N.C.
C	Air/nitrogen gauge
D	Push-rod
E	Alarm test ball valve, N.C.
F	Drip check valve
G	Prime level test valve, N.C.
H	Upstream accelerator Isolation valve, N.O.
I	Downstream accelerator valve, N.O.



To place the Viking Model VXR Dry Valve System in service, follow the procedure below and refer to Figure 9 above:

## NOTICE

**The system must be completely drained before proceeding.**

**NOTE: If preferred, press the Signal Silence button on the VFR-500 Release Control Panel to silence all buzzer outputs until placing the system in service.**

1. Verify that all equipment is adequately heated and protected to prevent freezing and physical damage.
2. Close the main water supply control valve (A).
3. Open the main drain valve (B).
4. Drain all water from the dry pipe system. If the system has previously operated, or if water has entered the system, open the prime level test valve (G). Allow enough time to pass for the system to drain completely.
5. Isolate the air supply (close the ball valves on the D-2 air maintenance device, if applicable).
6. Verify that the dry pipe system is not pressurized and that the air/nitrogen gauge (C) reads ZERO.
7. Press the push-rod (D) upward, then pull it downward, to lift the latch and ensure the clapper is fully closed.
8. Close the upstream accelerator isolation valve (H), the prime level test valve (G), and the alarm test valve (E). The main drain should remain open.

## CAUTION

**Excessive air/nitrogen pressure in the system piping will cause damage. Never exceed the maximum PSI/bar in the system piping when the dry valve clapper is closed. For the exact maximum PSI/bar, refer to Viking technical data for the dry pipe system in use.**

9. Open the dry air/nitrogen supply. When the system reaches approximately 10 PSI (0.7 bar), and while the system is in the process of reaching its intended air/nitrogen pressure, “blow down” each drain valve one at a time. Also “blow down” the prime level test valve at the dry valve and the inspector’s test connection. Close the valves once they are completely drained.

**NOTE: “Blowing down” the drain valves, prime level test valve (G), and inspector’s test connection when the system reaches approximately 10 PSI (0.7 bar) ensures the system is completely drained.**

10. When the system reaches its intended pressure and is stabilized, open the upstream accelerator isolation valve (H), then press the Reset button on the VFR-500 Release Control Panel to de-energize the solenoid valve.
11. Clear away dirt and debris from the fittings and nipples connected to the solenoid valve.
  - Open the inspector’s test connection, wait 5 seconds, then close the inspector’s test connection. Verify that the accelerator activation time is close to what it was throughout previous tests.

**NOTE: A momentary burst of air from the drip check valve indicates that the accelerator was activated. This procedure may cause the dry pipe valve to activate. If activation occurs, repeat steps 1-8 above, skipping steps 9-10. If the accelerator did NOT activate, perform steps 12-18 below:**

12. Once the air pressure is stabilized, press the Reset button on the VFR-500 Release Control Panel to de-energize the solenoid valve.
13. Press the drip check valve (F) to verify that the dry valve’s intermediate chamber is empty (no air/nitrogen).
14. When the air/nitrogen pressure is properly set, SLOWLY open the water supply control valve (A).
15. When the main drain’s water flow is developed, SLOWLY close the main drain valve (B).
16. Press the drip check valve (F) to verify that the dry valve’s intermediate chamber is empty (no water).
17. Secure all valves in their normal operating positions. (Refer to Figure 9.)
18. When the system is in service, notify the appropriate AHJs and those in the affected area.

**TECHNICAL DATA SHEET**
**MODEL EA-1 ELECTRONIC  
ACCELERATOR**
**VXR Supervisory Alarm Low/High Air/Nitrogen Pressure Settings**

Refer to current Viking technical data describing the Viking Model VXR Dry Valve System's individual components. Also, refer to applicable installation standards, codes, and local jurisdictional requirements.

For air/nitrogen supply installation:

- Use a compressor that will produce the required cubic feet per minute. (For more details, see the Viking technical datasheet F\_112320).
- Ensure that the air/nitrogen supplies are clean, dry, and oil-free.
- Regulate and restrict the automatic air/nitrogen supplies, and ensure the supplies come from a continuous source.
- A Viking D-2 Air Maintenance Device should be installed on each system equipped with a tank-mounted compressor. (**NOTE: For compressors with a capacity less than 5.5 ft<sup>3</sup>/min at 10 PSI (0.7 bar), NFPA 13 does not require an air maintenance device. The use of an air maintenance device with riser-mounted compressors can lead to compressor "short cycling." Viking always recommends using a tank-mounted compressor with air maintenance device.**)

VXR Supervisory Alarm Pressure Settings					
Maximum Water Pressure		Minimum Air/Nitrogen Pressure		Maximum Air/Nitrogen Pressure	
PSI	Bar	PSI	Bar	PSI	Bar
50	3.4	25	1.7	35	2.1
75	5.1	30	2.1	40	2.8
100	6.8	35	2.4	40	2.8
125	8.6	35	2.4	45	3.1
150	10.3	40	2.8	45	3.1
175	12.0	45	3.1	50	3.5
200	13.7	50	3.5	60	4.1
225	15.5	55	3.8	65	4.5
250	17.2	60	4.1	65	4.5

Set the rotary switch and the supervisory alarm to their appropriate pressure settings. (For rotary switch pressure settings, see Section 5.2).

## 8.4 Placing the Model F Dry Valve System in Service

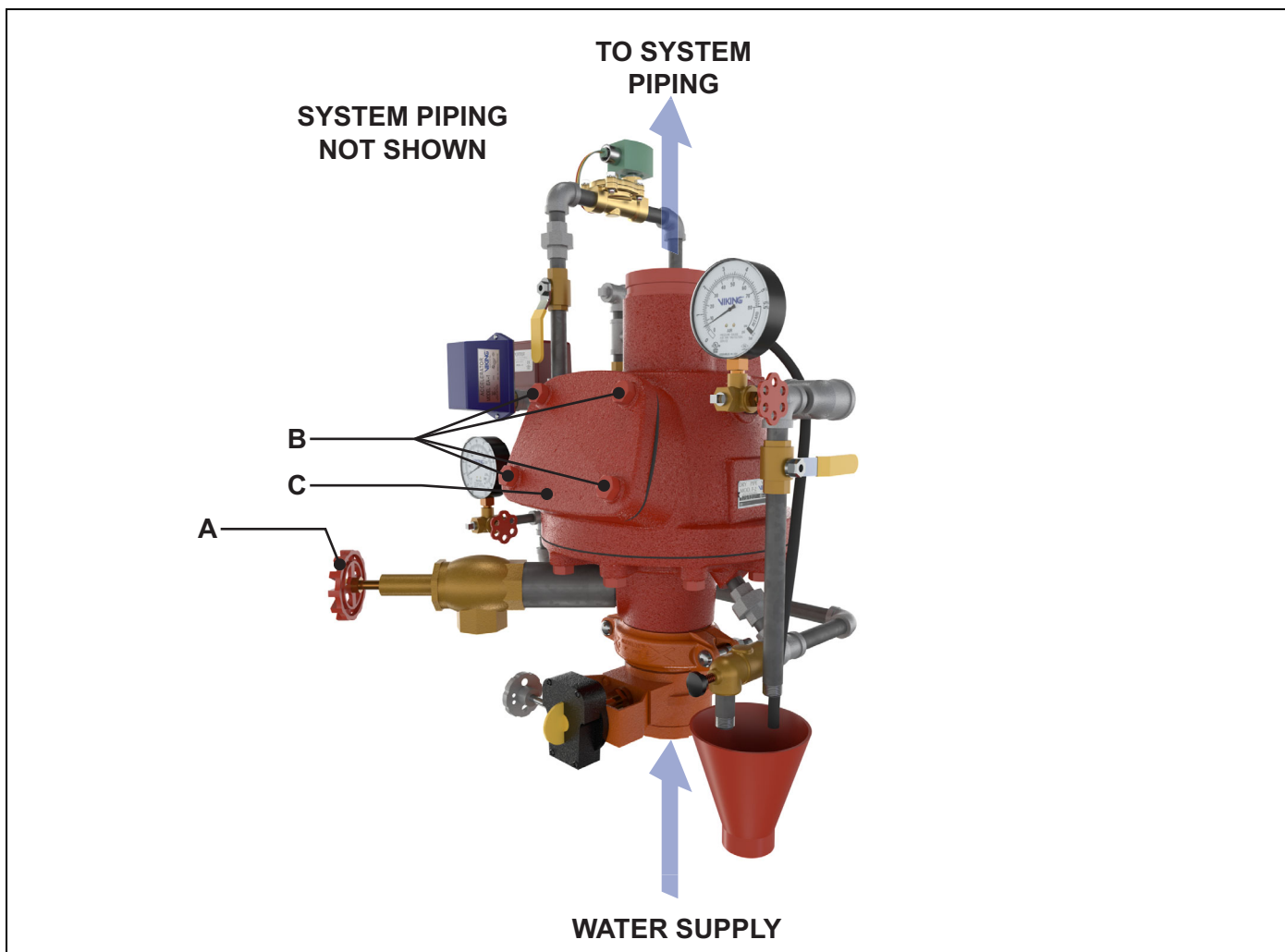

Figure – 10: Resetting the Model F Dry Valve

To place the Viking Model F Dry Valve in service, follow the procedure below and refer to Figure 10.

### NOTICE

The system must be completely drained before proceeding.

**NOTE:** If preferred, press the *Signal Silence* button on the VFR-500 Release Control Panel to silence all buzzer outputs until placing the system in service.

1. Verify that all equipment is adequately heated and protected to prevent freezing and physical damage.
2. Verify that the main control valve supplying water to the dry valve is closed.
3. Open the main drain valve (A).

4. Drain all water from the dry pipe system. If the system has operated, or if water has entered the system, open all auxiliary drains and the system test valve. Allow enough time to pass for the system to drain completely. Perform steps 4 through 10 below to set the dry valve and/or to inspect the dry valve's internal operating parts.
5. Verify that the dry pipe system is NOT pressurized.

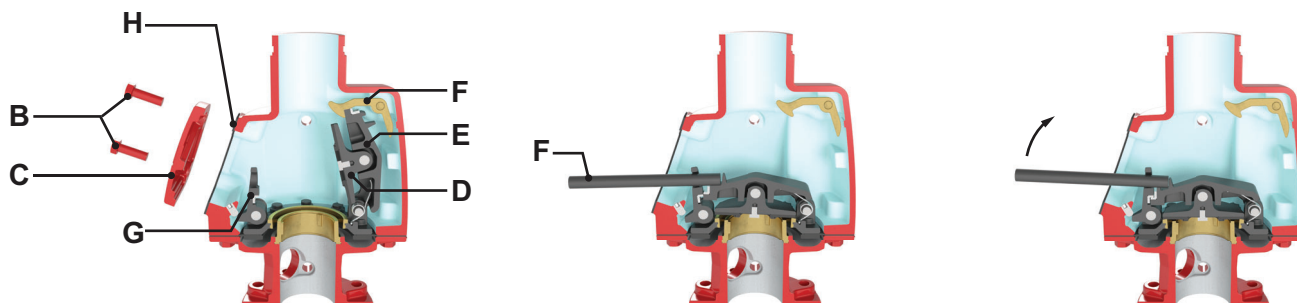

Figure – 11: Resetting the Model F Dry Valve

6. Use the dry valve reset bar/wrench (F - part number. 02977BWB) to loosen and remove hand-hole cover bolts (B). Remove the hand-hole cover (C).

### WARNING

The clapper arm assembly (E) and the clapper assembly (D) are spring-loaded to open. Never place hands inside the dry valve if the clapper assembly is latched closed.

**NOTE: Step 7 below is part of the annual activation test.**

7. Inspect and clean the dry valve's internal parts. Give special consideration to the water seat, air seat, and clapper rubber. Wipe away all contaminants, dirt, and mineral deposits. Do NOT use solvents or abrasives. Operate all parts to test their freedom of movement. As needed, repair or replace damaged or worn parts.

### CAUTION

**NEVER apply any lubricant to system seats, gaskets, or any dry pipe valve internal operation part. Petroleum-based grease or oil will damage rubber components and may prevent proper dry valve operation.**

8. To set the dry pipe valve clapper, refer to Figure 11 and perform the following:
  - Raise the latch (F) to release the spring-loaded clapper arm assembly (E) from the open position.
  - Move the clapper arm assembly (E) down toward the horizontal position.
  - While holding the spring-loaded clapper arm assembly (E) down, insert the resetting tool through the hook assembly (G) hole and across the fulcrum (on top of clapper arm assembly (E)). Do this until the resetting tool contacts the stopping boss.
  - Apply a sharp upward force at the end of the re-setting tool. The hook (G) will slide forward on the re-setting bar and latch the clapper closed with a positive setting action.
9. Verify that the dry valve's intermediate chamber is empty. No water should flow from the drip check when the plunger is pushed.
10. Visually inspect hand-hole cover gasket (H). Verify that it is in good condition.
11. Re-install hand-hole cover (C), gasket (H), and hand-hole cover bolts (B). Tighten the bolts using the dry valve reset bar/wrench (part number 02977BWB).



12. **On the trim:** Close the upstream accelerator isolation valve, the system test valve, and the priming water level test valve. The main drain should remain open.

### **⚠ CAUTION**

**Excessive air/nitrogen pressure in the system piping will cause damage. Never exceed the maximum PSI/bar in the system piping when the dry valve clapper is closed. For the exact maximum PSI/bar, refer to Viking technical data for the dry pipe system in use.**

13. Open the dry air/nitrogen supply. When the system reaches approximately 10 PSI (0.7 bar), and while the system is in process of reaching its intended air/nitrogen pressure, “blow down” each drain valve one at a time. Also “blow down” the priming level test valve at the dry pipe valve and the inspector’s test connection. Close the valves once they are completely drained.

**NOTE: By “blowing down” the drain valves, the test valve, and the inspector’s test connection when the system reaches approximately 10 PSI (0.7 bar), it will ensure the system is completely drained.**

14. When the system reaches its intended pressure and is stabilized, open the isolation valve and then press the Reset button on the VFR-500 Release Control Panel to de-energize the solenoid valve.

15. Clear away dirt and debris from the fittings and nipples connected to the solenoid valve.

- Open the inspector’s test connection, wait 5 seconds, then close the inspector’s test connection. Verify that the accelerator activation time is close to what it was throughout previous tests.

**NOTE: A momentary burst of air from the drip check valve indicates that the accelerator was activated. If activation occurs, repeat steps 1-12 above, skipping steps 13-14. If the accelerator did NOT activate, perform steps 15-21 below:**

16. Once the air pressure is stabilized, press the Reset button on the VFR-500 Release Control Panel to de-energize the solenoid valve.
17. Verify that the dry valve’s intermediate chamber is empty. No water should flow from the drip check when the plunger is pushed.
18. Slowly open the water supply main control valve.
19. When flow is developed from the main drain, slowly close the main drain valve.
20. Fully open the water supply main control valve.
21. Secure all valves in their normal operating positions.
22. Notify the appropriate AHJs and those in the affected area that the system is in service.



## 9. COILKEEPER™ SUPERVISORY SWITCH

### Description

The CoilKeeper™ Supervisory Switch is used on a preaction system or a dry pipe system when it includes the EA-1. It is designed to monitor the position of a coil on a solenoid electronically and to determine if the coil is installed on the valve stem. If the coil is removed, the switch will activate a set of dry contacts (normally open) that can be wired to a supervisory circuit on the releasing control panel.

Local LED(s) at the switch shows:

- when the coil is in a normal state on the valve body.
- when the coil is removed from the valve body in a maintenance state.
- when the releasing circuit is energized.
- when/if the coil is open or shorted.

### WARNING

For more product details and for product installation instructions, refer to the manufacturer's documentation.

### 9.1 Features

- Coil monitoring
- Able to show coil state through simple LEDs
- Detects open and shorted coils
- Can be remotely mounted or mounted at the solenoid
- Provides visual indication of the coil and the releasing circuit status

### 9.2 Specifications

Parameter	Value
Conduit Entrances	1/2" conduit connections provided (3 total)
Contact Ratings	1A at 30VDC Resistive
Dimensions	4.38" W x 4.00" H x 1.90" D
Enclosure	UV and impact-resistant polycarbonate
Environmental Limitations	NEMA type 2 for indoor dry use
Power Requirements	24VDC, 20mA max standby, 40 mA max alarm (20 mA AUX power, 20 mA releasing circuit)
Shipping Weight	1.25 lbs
Solenoid Valves	For use with 24V solenoid valves that are UL Listed for releasing service
Wattage Range	CSS-10: 9-11 Watts
Temperature Range	32°F to 120°F (0°C to 49°C)
Wire Range	12-22 AWG

**NOTE: Specifications are subject to change without notice.**



### 9.3 CoilKeeper™ Wiring Diagram

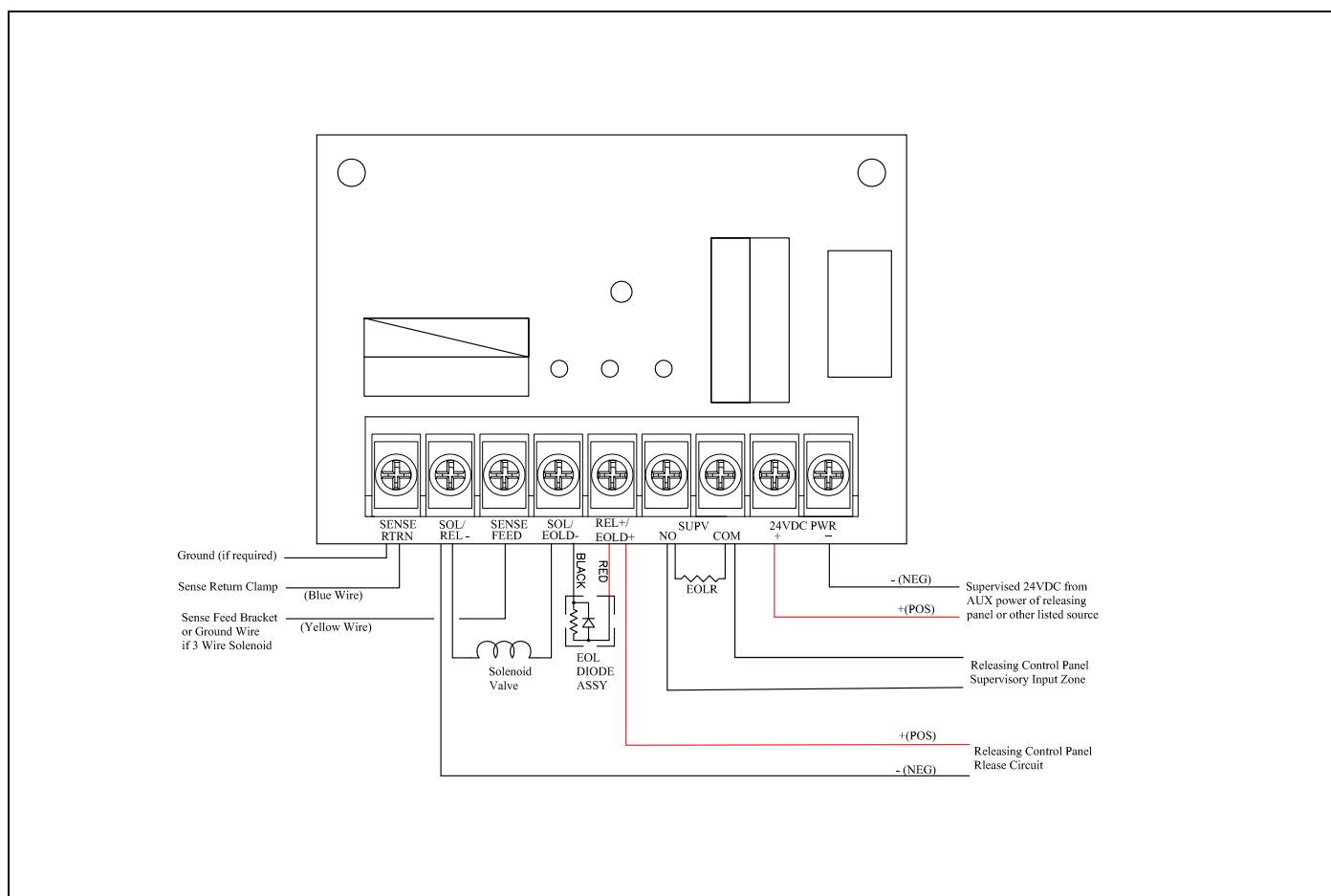

Figure – 12: CoilKeeper Wire Inputs

For more details concerning the CoilKeeper wiring diagram, refer to the manufacturer's associated technical documentation.

## 10. CONTACT

The Model EA-1 Accelerator is available through Viking distributors only. Contact your local Viking sales office, which can be found on our website:

[www.vikinggroupinc.com/locations](http://www.vikinggroupinc.com/locations)

The Viking Corporation  
5150 Beltway SE  
Caledonia, MI 49316  
Tel.: (800) 968-9501  
Fax: 269-818-1680  
Technical Services: 1-877-384-5464  
techsvcs@vikingcorp.com



## 11. CARE AND HANDLING

### 11.1 Warranty

For warranty details, refer to Viking's current list price schedule at [www.vikinggroupinc.com](http://www.vikinggroupinc.com), or contact Viking Corp directly. Refer to section 10.

### 11.2 Inspections, Testing, and Maintenance

#### **⚠ WARNING**

**Any system maintenance that involves placing a control valve or detection system out of service may eliminate that system's fire protection capabilities. Prior to proceeding, notify all AHJ. Consideration should be given to employment of a fire patrol in the affected areas.**

#### **NOTICE**

**The owner is responsible for maintaining the fire protection system and devices in proper operation condition.**

According to NFPA, a system must undergo regular testing and inspection. Refer to current Viking technical data for details on individual components.

Inspection frequency may vary due to contaminated or corrosive water supplies, corrosive atmospheres, and the condition of the air/nitrogen supply to the system. For maintenance and inspection requirements, refer to NFPA standards and the AHJ.

**For double interlock preaction system testing, perform the following:**

1. Operate the detection system, then open the inspector's test connection.
2. Verify that the accelerator activation time is close to what it was throughout previous tests.

***NOTE: Releasing the VXD's diaphragm pressure through the open solenoid valve is an indication that the accelerator activated. The VFR-500 Release Control Panel's interface also indicates when/if the accelerator is in operation.***

**For dry valve system testing, perform the following:**

#### **⚠ CAUTION**

**Excessive air/nitrogen pressure in the system piping will cause damage. Never exceed the maximum PSI/bar in the system piping when the dry valve clapper is closed. For the exact maximum PSI/bar, refer to Viking technical data for the dry pipe system in use.**

1. Open the dry air/nitrogen supply. When the system reaches approximately 10 PSI (0.7 bar), and while the system is in process of reaching its intended air/nitrogen pressure, "blow down" each drain valve one at a time. Also "blow down" the priming level test valve at the dry valve and the inspector's test connection. Close the valves once they are completely drained.

***NOTE: By "blowing down" the drain valves, the test valve, and the inspector's test connection when the system reaches approximately 10 PSI (0.7 bar), it will ensure the system is completely drained.***



## TECHNICAL DATA SHEET

MODEL EA-1 ELECTRONIC  
ACCELERATOR

2. When the system reaches its intended pressure and is stabilized, press the Reset button on the VFR-500 Release Control Panel to de-energize the solenoid valve.
3. Clear away dirt and debris from the fittings and nipples connected to the solenoid valve.
  - Open the inspector's test connection, wait 5 seconds, then close the inspector's test connection. Verify that the accelerator activation time is close to what it was throughout previous tests.

***NOTE: A momentary burst of air from the drip check valve indicates that the accelerator was activated.***