



TECHNICAL DATA SHEET

VK2023 Standard Response Pendent Sprinkler K8.0 (115)

1. PRODUCT IDENTIFICATION

This document covers the following product, hereafter referred to as “sprinkler”:

VK2023: Standard Response, Standard Coverage, Pendent, K8.0 (115) Sprinkler.

2. INTENDED USE

The sprinkler is intended to be used in automatic fire sprinkler systems as a temporary sprinkler while a building is under construction. The sprinkler must be used in accordance with:

1. the sprinkler’s Listings, Approvals, and associated design requirements.
2. the recognized design and installation standards issued, for example NFPA, FM, EN, VdS, or LPCB.
3. the latest revisions of all applicable manufacturer’s documentation.

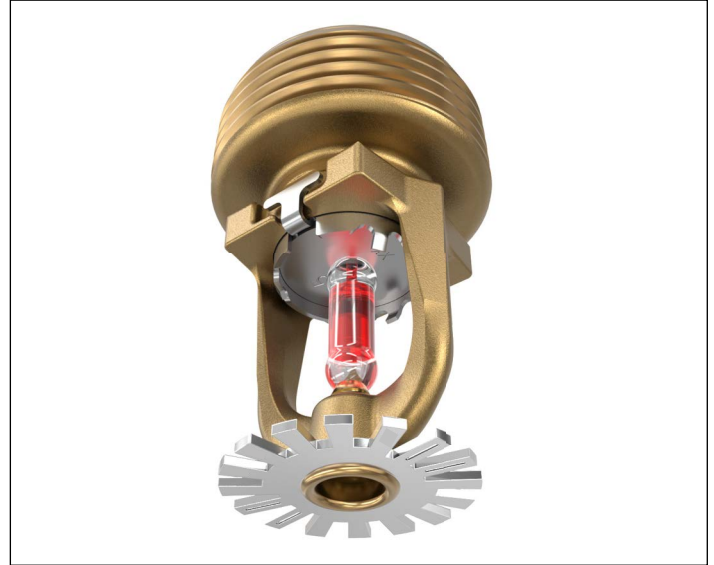

Governmental codes, ordinances, and standards may apply and may differ from one another.

WARNING

Cancer and Reproductive Harm www.P65Warnings.ca.gov

3. LISTING AND APPROVALS

Refer to section 5 for details and requirements that must be followed.



4. TECHNICAL SPECIFICATIONS

4.1 Definitions

Standard Pendent Sprinkler: A sprinkler intended to be oriented with the deflector below the frame so water flows downward through the orifice, striking the deflector and forming an umbrella-shaped spray pattern downward. =

Corrosion-Resistant Sprinkler: A special service sprinkler with non-corrosive protective coatings, or that is fabricated from non-corrosive material, for use in atmospheres that would normally corrode sprinklers. Sprinklers can be ordered as corrosion resistant sprinklers and can be used with escutcheons when allowed by the approval body.

TECHNICAL DATA SHEET
**VK2023 Standard Response
Pendent Sprinkler K8.0 (115)**
4.2 Ratings and Physical Characteristics

Parameter	Value
Minimum operating pressure	7 PSI (0.5 bar)
Maximum rated pressure	175 PSI (12 bar)
Factory tested pressure	500 PSI (35 bar)
Thread size	1" NPT
Nominal K-factor	8.0 U.S. (115)
Minimum temperature rating (glass bulb)	-65 °F (-55 °C)

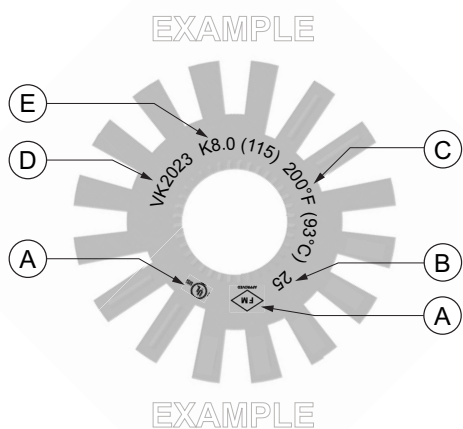
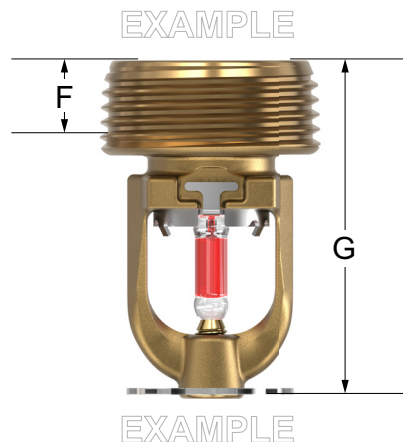
4.3 Markings and Dimensions

Figure – 1: Markings

Figure – 2: Dimensions

Ref	Description	Value
A	Listings and Approvals	See sections 3 and 5
B	Manufacture date (year)	See marking
C	Nominal temperature rating	See marking
D	Manufacturers Sprinkler Identification Number (SIN)	VK2023
E	K-factor (metric)	K5.6 (80.6)
F	Nominal pipe engagement	7/16" (11 mm)
G	Height	2" (51 mm)

4.4 Materials of Construction

NOTICE: Do not disassemble the sprinkler.

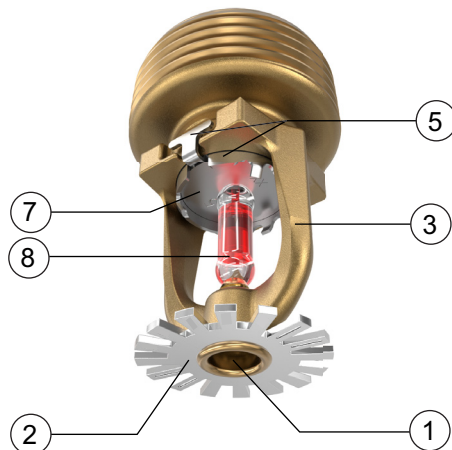

Figure – 3: Sprinkler Components

Ref	Description	Material
1	Compression screw	Brass CW612N, CW508L, UNS-C36000 or UNS-C26000
2	Deflector	Stainless steel UNS S30400
3	Sprinkler body	DZR brass
4	Pip cap seal (not shown)	Polytetrafluoroethylene (PTFE)
5	Pip cap shell	Stainless steel UNS-S44400
6	Belleville spring (not shown)	Nickel alloy
7	Pip cap disc	Stainless steel UNS-S30100
8	Bulb	Glass, nominal 0.20" (5 mm) diameter

TECHNICAL DATA SHEET
**VK2023 Standard Response
Pendent Sprinkler K8.0 (115)**
5. LISTING AND APPROVAL DESIGN REQUIREMENTS
5.1 Listing and Approval Specifications

Sprinkler Base Part Number ¹	Thread Size		Approval Body	
	NPT	BSPT	cULus	FM
Maximum WWP PSI (bar) →			175 (12)	
27202	1"	—	A1	A1
Approval Specification (Temperature Ratings) Key:				
A = 135 °F (57 °C), 155 °F (68 °C), 175 °F (79 °C), 200 °F (93 °C) and 286 °F (141 °C)				
Approval Specification (Finishes) Key:				
1 = Brass, chrome, white polyester ^{2,3} , black polyester ^{2,3} , and ENT ^{3,4}				
1. For complete part number, refer to Viking's current price list.				
2. For white polyester and black polyester, other colors are available upon request and will carry the same Listings and Approvals as the standard colors.				
3. cULus Listed as corrosion-resistant.				
4. FM Approved as corrosion-resistant.				

5.2 cULus Listing Requirements and Details

The sprinkler is cULus Listed, as indicated in Table 5.1, for installation in accordance with the latest edition of NFPA 13 for standard spray sprinklers. This sprinkler is designed for use in light, ordinary, and extra hazard occupancies. Venting is not required.

5.3 FM Approval Requirements and Details

The sprinkler is FM Approved as standard response Non–Storage pendent sprinkler as indicated in the FM Approval Guide. The sprinkler is also approved for use in FM Approved vacuum dry sprinkler systems with a maximum supervisory vacuum pressure of –3 psi (–207 mbar). FM Global Loss Prevention Data Sheets contain guidelines relating to, but not limited to: minimum water supply requirements, hydraulic design, ceiling slope and obstructions, minimum and maximum allowable spacing, and deflector distance below the ceiling. For specific application and installation requirements, refer to the latest applicable FM Loss Prevention Data Sheets (including Data Sheet 2–0).

5.4 Corrosion-Resistant Coatings

The corrosion resistant coatings have passed the standard corrosion tests required by the approving agencies and are listed and approved as indicated in Table 5.1. These tests do not represent all possible corrosive environments. The Electro-less Nickel PTFE (ENT) finish passed the UL 199 thirty day corrosion test and is cULus listed and FM Approved as corrosion resistant. For automatic sprinklers, the ENT coating is applied to all exposed exterior surfaces, including the waterway.

Prior to installation, verify that the coatings are compatible with, or suitable for, the proposed environment. The ENT finish has not been evaluated for environments containing chlorine, such as indoor swimming pools. It is not recommended for these applications.

5.5 Sprinkler Guards and Water Shields

The sprinkler is approved for use with the Model XG Sprinkler Guard. Refer to the Guards and Water Shields for XT1 Sprinklers technical data sheet for more information.

TECHNICAL DATA SHEET
**VK2023 Standard Response
Pendent Sprinkler K8.0 (115)**
5.6 Available Temperature Ratings

Viking sprinklers are available in several temperature ratings that relate to a specific temperature classification. Applicable installation rules mandate the use and limitations of each temperature classification. In selecting the appropriate temperature classification, the maximum expected ceiling temperature must be known. When there is doubt as to the maximum temperature at the sprinkler location, a maximum-reading thermometer should be used to determine the temperature under conditions that would show the highest readings to be expected. In addition, recognized installation rules may require a higher temperature classification, depending upon sprinkler location, occupancy classification, commodity classification, storage height, and other hazards. In all cases, the maximum expected ceiling temperature dictates the lowest allowable temperature classification. Sprinklers located immediately adjacent to a heat source may require a higher temperature rating.

6. ORDERING PROCEDURE
NOTICE

Improperly installing the sprinkler in an InstaSeal® fitting may damage the sprinkler and/or the fitting. For sprinklers being installed in InstaSeal® fitting, refer to the installation instructions in F_021223 (IS-W2 InstaSeal® welded sprinkler fittings) or F_032219 (CPVC InstaSeal® adapter).

6.1 Sprinkler

1. Choose a sprinkler base part number with the required thread size and listing or approval (refer to section 5):
2. Add the suffix for the desired finish.
3. Add the suffix for the desired temperature rating.

NOTE: For Polyester, insert the desired temperature rating suffix where the dash (–) is shown.

EXAMPLE: 27202MB/W = VK2023 with white polyester finish and 155 °F (68 °C) nominal temperature rating. This sprinkler is to be installed into an area with a maximum ambient temperature of 100 °F (38 °C).

1. Sprinkler Base Part Number		2. Finish		3. Temperature Rating			
See Section 5		Description	Suffix	Nominal Temperature Rating	Bulb Color	Maximum Ambient Ceiling Temperature	Suffix
27202	1" NPT	Brass	A	135 °F (57 °C)	Orange	100 °F (38 °C)	A
		Chrome	F	155 °F (68 °C)	Red	100 °F (38 °C)	B
		White Polyester	M–/W	175 °F (79 °C)	Yellow	150 °F (65 °C)	D
		Black Polyester	M–/B	200 °F (93 °C)	Green	150 °F (65 °C)	E
		ENT	JN	286 °F (141 °C)	Blue	225 °F (107 °C)	G
				OPEN	—	—	Z

6.2 Sprinkler Accessories



Figure – 4: Sprinkler Accessories

Image Reference	Part Number	Description
1)	29270MB	Straight wrench: required for proper installation
2)	01724A	Sprinkler cabinet: holds up to 6 sprinklers
3)	01725A	Sprinkler cabinet: holds up to 12 sprinklers (not shown)
4)	26676	1" InstaSeal sprinkler alignment tool

7. CONTACT

The sprinkler and accessories are available through Viking distributors only. Contact your local Viking sales office which can be found on our website:

Americas and Asia: www.vikinggroupinc.com/locations OR Europe, Middle East, Africa (EMEA): www.viking-emea.com/contact

Manufacturer:

The Viking Corporation
5150 Beltway SE
Caledonia, MI 49316
Tel.: (800) 968-9501
Fax: 269-818-1680
Technical Services: 1-877-384-5464
techsvcs@vikingcorp.com

Importer EU:

Viking S.A.
21, Z.I., Haneboesch
L-4562 Differdange / Niederkorn
Tel.: +352 58 37 37 – 1
Fax: +352 58 37 36
vikinglux@viking-emea.com

Asia Pacific (APAC) Main Office:

The Viking Corporation (Far East) Pte. Ltd.
69 Tuas View Square
Westlink Techpark, Singapore 637621
Tel: (+65) 6 278 4061
Fax: (+65) 6 278 4609
vikingAPAC@vikingcorp.com



Handling and Installation Instructions

Model XT-1 Pendent Sprinklers

	bg	Инсталирайте и пуснете продукта в експлоатация само ако следната инструкция е ясно разбрана.	lv	Produkta iemontēšanu un ekspluatācijas sākšanu veikt tikai tad, ja dotā instrukcija ir pilnībā saprasta.
	cs	Namontujte a spust'te do provozu produkt pouze tehdy, když jste jasně pochopili tento návod.	lt	Produktą montuokite ir pradėkite eksploatuoti tik tuomet, jei aiškiai suprantate šią instrukciją.
	de	Du må kun montere og idriftsætte produktet, hvis du har forstået følgende vejledning til fulde.	mt	Installa u f'hadem il-prodott biss jekk l-istruzzjonijiet li ġejjin jinftiehm b'mod ċar.
	de	Produkt nur einbauen und in Betrieb nehmen, wenn die nachfolgende Anleitung klar verstanden wird.	nl	Product alleen installeren en in gebruik nemen, als de volgende instructies begrepen zijn.
	el	Η εγκατάσταση και θέση σε λειτουργία του προϊόντος επιτρέπονται μόνο εάν οι ακόλουθες οδηγίες έχουν γίνει κατανοητές.	no	Ikke installer og ta i bruk produktet uten at følgende anvisninger er tydelig forstått.
	en	Do not install and commission the product unless you have clearly understood the instructions below.	pl	Produkt należy montować i uruchamiać tylko wtedy, gdy poniższe instrukcje są w pełni zrozumiałe.
	es	Instalar el producto y ponerlo en funcionamiento solo cuando se hayan comprendido claramente las siguientes instrucciones.	pt	Instalar e colocar o produto em funcionamento somente se as instruções a seguir forem claramente compreendidas.
	et	Paigaldage toode ja kasutage seda ainult siis, kui saate alljärgnevast juhendist selgelt aru.	ro	Montați produsul și puneți-l în funcțiune numai dacă instrucțiunea următoare este înțeleasă clar.
	fi	Tuotteen saa asentaa ja ottaa käyttöön vain, jos jäljempänä oleva ohje ymmärretään selvästi.	ru	Не устанавливайте и не принимайте оборудование в эксплуатацию, если вы четко не поняли инструкции ниже
	fr	N'installez et ne mettez en service le produit que si les instructions suivantes ont été clairement comprises.	sk	Namontujte a spustite do prevádzky výrobok iba vtedy, pokiaľ ste jasne pochopili tento návod.
	ga	Ná déan an táirge a shuiteail agus a choimisiunu mura dtuigeann tu na teoracha thíos go soileir.	sl	Izdelek vgradite in zaženite samo, če ste dobro razumeli navodila v nadaljevanju.
	hr	Ne instalirajte i ne puštajte proizvod u rad ako niste jasno razumjeli donje upute.	sr	Не инсталирајте и не пуштајте производ у рад ако нисте јасно разумели упутства у наставку.
	hu	Csak akkor építse be a terméket és helyezze üzembe, ha a következő útmutatót egyértelműen megértette.	sv	Montera och driftsätt produkten endast om du förstår den efterföljande instruktionen.
	is	Settu ekki upp eða taktu vöruna í notkun nema þú hafir skilið greinilega leiðbeiningarnar hér að neðan.	tr	Aşağıdaki talimatları açıkça anlamadan ürünü kurmayın ve devreye almayın.
	it	Montare il prodotto e metterlo in funzione solo se si sono comprese appieno le seguenti istruzioni.		



1. PRODUCT IDENTIFICATION

This document covers the following products, hereafter referred to as “sprinkler”:

- VK850 Standard Response Pendent Sprinkler K5.6 (80.6)
- VK851 Standard Response Pendent Sprinkler K8.0 (115)
- VK852 Quick Response Pendent Sprinkler K5.6 (80.6)
- VK853 Quick Response Pendent Sprinkler K8.0 (115)
- VK1021 Standard Response Pendent Sprinkler K5.6 (80.6)
- VK1023 Standard Response Pendent Sprinkler K5.6 (80.6)
- VK2021 Standard Response Pendent Sprinkler K8.0 (115)
- VK2022 Standard Response Pendent Sprinkler K8.0 (115)
- VK2023 Standard Response Pendent Sprinkler K8.0 (115)
- VK3021 Quick Response Pendent Sprinkler K5.6 (80.6)
- VK3023 Quick Response Pendent Sprinkler K5.6 (80.6)
- VK3521 Quick Response Pendent Sprinkler K8.0 (115)
- VK3522 Quick Response Pendent Sprinkler K8.0 (115)
- VK3523 Quick Response Pendent Sprinkler K8.0 (115)

2. OTHER APPLICABLE DOCUMENTS

For intended use and relevant conditions for the safe use of the specific sprinkler refer to the appropriate *Technical Data Sheet*.

3. TRANSPORT AND HANDLING

WARNING

A damaged or compromised sprinkler poses the risk of fatal consequences.

Damaged or compromised sprinklers will not operate properly which could lead to loss of life.

- **NEVER** use a sprinkler that has been exposed to temperatures exceeding the maximum allowed ambient temperature.
- **NEVER** use a sprinkler with a loss of liquid from the glass bulb or damage to the fusible element. A small bubble should be visible within the glass bulb; rotate the sprinkler to a horizontal position while observing the bulb to see the bubble.
- **NEVER** use a sprinkler that has been dropped or damaged.
- **ALWAYS** Protect the sprinkler from mechanical damage during storage, transport, and handling.
- **NEVER** use sprinklers that have been painted by anyone other than the manufacturer.
- **ALWAYS** protect sprinklers from being painted during installation or replacement in accordance with the installation standards.
- **NEVER** clean sprinklers with anything other than 7 psi or lower compressed air.
- **NEVER** apply soap, water, ammonia, adhesives, solvents or any other fluids on sprinklers.
- Destroy every damaged or compromised sprinkler.

NOTICE

Protect sprinklers during transport and handling.

- **ALWAYS** handle the sprinkler with care.
- **ALWAYS** keep the protective cap on the sprinkler during transport and handling.
- **NEVER** remove the protective cap until the fire sprinkler system is placed in service and the potential for mechanical damage no longer exists.
- **ALWAYS** protect the sprinkler from direct sunlight during transport and handling.
- **ALWAYS** store sprinkler in a cool, dry, protected area.
- **ALWAYS** use original manufacturer’s shipping containers.



Handling and Installation Instructions

Model XT-1 Pendent Sprinklers

- NEVER store a sprinkler loose in a box, bin, bucket, or other type of container.
- ALWAYS keep the sprinkler separated from other sprinklers.
- NEVER allow metal parts to contact the sprinkler operating elements.

NOTE: If the glass bulb included on the sprinkler has been exposed to ultraviolet light, the color inside the bulb may fade. This color change does not affect the operation of the sprinkler.

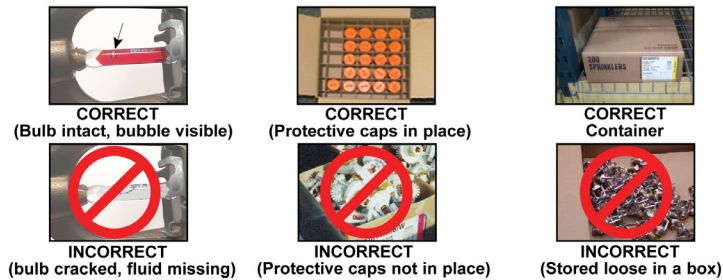

4. INSTALLATION

⚠ WARNING

Installation by insufficiently qualified personnel poses the risk of fatal consequences.

- This sprinkler must be installed properly by qualified personnel familiar with safe practices and applicable and recognized design and installation standards issued, for example, by NFPA, FM, VdS, or LPCB, and trained how to properly perform the installation procedures.

⚠ WARNING

Incorrect recessed installation poses the risk of fatal consequences.

- For recessed applications, this sprinkler must be installed according to the dimensions shown in Figure 1.

⚠ CAUTION

Cutting Hazard.

Sprinklers, accessories, cabinets, and packaging can have sharp edges that can cause cuts.

- Wear appropriate personal protective equipment (gloves) while handling product.

NOTICE

If the sprinkler will be installed into an IS-W2 InstaSeal™ fitting, refer to F_021123 or F_032219 (CPVC InstaSeal™ adapter) for the proper installation instructions.

NOTICE

If the sprinkler will be installed into an IS-W2 InstaSeal® fitting, refer to F_032219 (CPVC InstaSeal adapter) and one of the following documents for the proper installation instructions:

- F_021323 for 1/2" NPT sprinklers
- F_021123 for 3/4" NPT sprinklers



Handling and Installation Instructions

Model XT-1 Pendent Sprinklers

- F_021223 for 1" NPT sprinklers

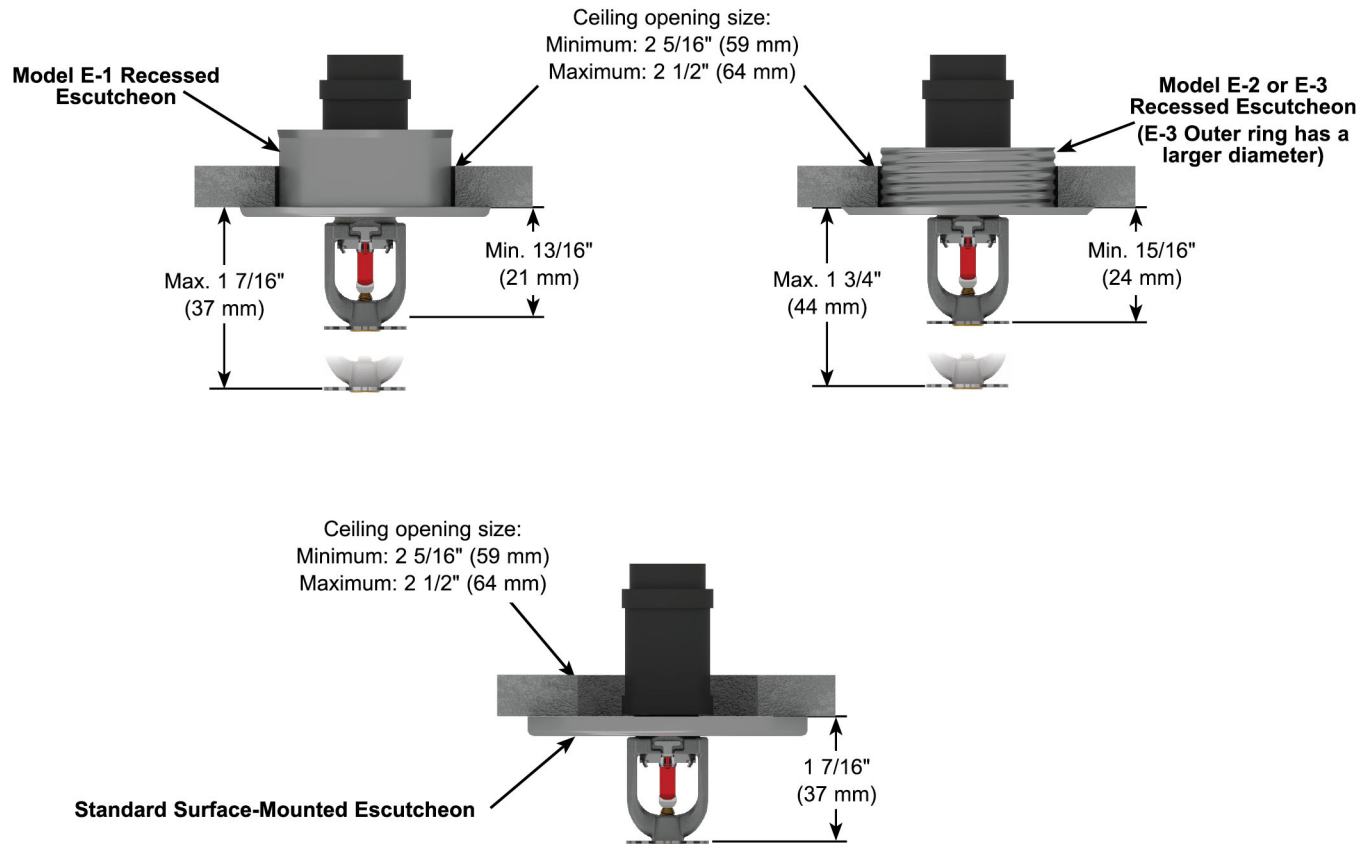

Figure – 1 Installation Dimensions with Viking Escutcheons

Optional Guards, Shields, and Escutcheons: If the sprinkler shall be installed together with a guard, shield, or escutcheon refer to the applicable documents for the products used.

1. Install all required piping in the intended installation location.
2. Verify that the sprinkler model/style, K-factor, temperature rating, and response characteristics are appropriate for the intended installation location. See Table 1 and Figure 5.
3. Inspect the sprinkler for damage. Destroy every damaged or compromised sprinkler. The following are examples in which sprinklers are considered damaged or compromised. Replace the sprinkler in the following cases:
 - Sprinkler with a loss of fluid from the glass bulb or damage to the fusible element.
 - Sprinklers that have been field painted, caulked, or mechanically damaged.
 - Sprinklers showing signs of corrosion.
4. Verify that the sprinkler is protected with the protective cap or clip.

5. Apply a small amount of pipe-joint compound or tape to the external threads of the sprinkler only. Do not allow a build-up of compound inside the sprinkler inlet (Figure 2).

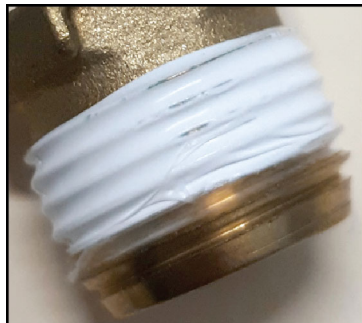

Figure – 2

6. If applicable, Install the escutcheon on the sprinkler threads.
7. **NOTICE: Do not use the deflector to start threading the sprinkler into a fitting. Use ONLY the approved wrench to install the sprinkler. Refer to the sprinkler's *Technical Data Sheet*.**
- a) **For recessed sprinkler wrench (Figure 3a):** Carefully slide the wrench sideways around the protective cap and push upwards to engage with the sprinkler wrench flats.
- b) **For the standard sprinkler wrench (Figure 3b):** Carefully slide the wrench onto the sprinkler wrench flats.

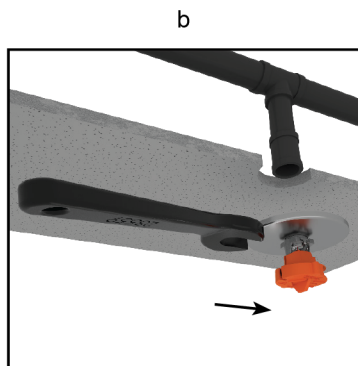
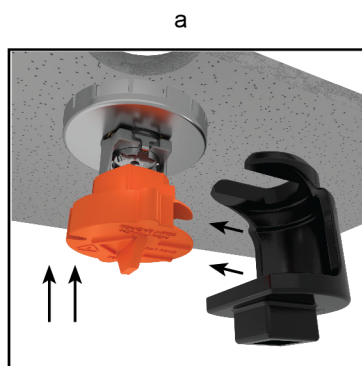

Figure – 3



Handling and Installation Instructions

Model XT-1 Pendent Sprinklers

5. CONTACT

The sprinkler and accessories are available through Viking distributors only. Contact your local Viking sales office which can be found on our website:

Americas and Asia: www.vikinggroupinc.com/locations OR Europe, Middle East, Africa (EMEA): www.viking-emea.com/contact

Manufacturer:

The Viking Corporation
5150 Beltway SE
Caledonia, MI 49316
Tel.: (800) 968-9501
Fax: 269-818-1680
Technical Services: 1-877-384-5464
techsvcs@vikingcorp.com

Importer EU:

Viking S.A.
21, Z.I, Haneboesch
L-4562 Differdange / Niederkorn
Tel.: +352 58 37 37 – 1
Fax: +352 58 37 36
vikinglux@viking-emea.com

Asia Pacific (APAC) Main Office:

The Viking Corporation (Far East) Pte. Ltd.
69 Tuas View Square
Westlink Techpark, Singapore 637621
Tel: (+65) 6 278 4061
Fax: (+65) 6 278 4609
vikingAPAC@vikingcorp.com



1. PRODUCT IDENTIFICATION

This document covers the following product, hereafter referred to as “sprinkler” (SR = Standard Response, QR = Quick Response):

- VK1001 SR Upright Sprinkler K5.6 (80.6)
- VK1003 SR Upright Sprinkler K5.6 (80.6)
- VK2001 SR Upright Sprinkler K8.0 (115)
- VK2002 SR Upright Sprinkler K8.0 (115)
- VK2003 SR Upright Sprinkler K8.0 (115)
- VK3001 QR Upright Sprinkler K5.6 (80.6)
- VK3003 QR Upright Sprinkler K5.6 (80.6)
- VK3501 QR Upright Sprinkler K8.0 (115)
- VK3502 QR Upright Sprinkler K8.0 (115)
- VK3503 QR Upright Sprinkler K8.0 (115)
- VK850 SR Pendent Sprinkler K5.6 (80.6)
- VK851 SR Pendent Sprinkler K8.0 (115)
- VK852 QR Pendent Sprinkler K5.6 (80.6)
- VK853 QR Pendent Sprinkler K8.0 (115)
- VK1021 SR Pendent Sprinkler K5.6 (80.6)
- VK1023 SR Pendent Sprinkler K5.6 (80.6)
- VK2021 SR Pendent Sprinkler K8.0 (115)
- VK2022 SR Pendent Sprinkler K8.0 (115)
- VK2023 SR Pendent Sprinkler K8.0 (115)
- VK3021 QR Pendent Sprinkler K5.6 (80.6)
- VK3521 QR Pendent Sprinkler K8.0 (115)
- VK3522 QR Pendent Sprinkler K8.0 (115)
- VK3523 QR Pendent Sprinkler K8.0 (115)
- VK1181 SR Conventional Sprinkler K5.6 (80.6)
- VK1201 SR Conventional Sprinkler K8.0 (115)
- VK1202 SR Conventional Sprinkler K8.0 (115)
- VK3101 QR Conventional Sprinkler K5.6 (80.6)
- VK3541 QR Conventional Sprinkler K8.0 (115)
- VK3542 QR Conventional Sprinkler K8.0 (115)

WARNING

Cancer and Reproductive Harm www.P65Warning.ca.gov

2. OTHER APPLICABLE DOCUMENTS

For intended use and relevant conditions for the safe use of the specific sprinkler, refer to the appropriate Technical Data Sheet. In case an installed sprinkler needs to be replaced, refer to the appropriate Handling and Installation Instructions for the installation of the new sprinkler.

3. MAINTAINING OPERATIONAL READINESS

Functionality

During fire conditions, the operating element fuses or shatters (depending on the type of sprinkler), releasing the pip cap and sealing assembly. Water flowing through the sprinkler orifice strikes the sprinkler deflector, forming a uniform spray pattern to control or extinguish the fire.

WARNING

This section contains important safety information. Read and follow all information.

Damaged or Compromised Sprinklers

Damaged or compromised sprinklers will not operate properly which could lead to loss of life.

- **NEVER** clean, paint, or caulk sprinklers.
- **NEVER** apply soap, water, ammonia, adhesives, solvents or any other fluids on sprinklers.
- **NEVER** expose sprinklers to temperatures exceeding the maximum allowed ambient ceiling temperature. See the Technical Data Sheet.
- **ALWAYS** replace a compromised or damaged sprinkler.
- **NEVER** attempt to repair or reassemble a sprinkler.
- **ALWAYS** replace operated sprinklers and cover assemblies and sprinklers exposed to corrosive products of combustion.
- Replacement of sprinklers must only be performed following the instructions in section 4.



The following are examples in which sprinklers are considered damaged or compromised. Replace the sprinkler in the following cases:

- Sprinkler with a loss of fluid from the glass bulb or damage to the fusible element.
- Sprinklers or cover plate assemblies that have been field painted, caulked, or mechanically damaged.
- Sprinklers showing signs of extraordinary corrosion.

Obstructions and obstacles

Obstructions and obstacles may compromise sprinkler discharge patterns which are critical for proper fire protection.

- **NEVER** attach items to sprinklers or hang items from the ceiling in an area protected with sprinklers.
- **NEVER** install walls in areas protected with sprinklers without having a specialized company verifying the design of the sprinkler system.
- **ALWAYS** remove obstructions and obstacles to sprinkler spray patterns.

Sprinkler systems that have been subjected to a fire

Sprinkler systems that have been subjected to a fire must be returned to service as soon as possible.

- **After an event of fire, the entire sprinkler system must be inspected for damage and repaired as necessary.**
- **Refer to the minimum requirements of the Authority Having Jurisdiction for replacement of sprinklers.**
- **Consider the employment of a fire patrol as long as the sprinkler system is out of service.**

Inspections and testing

The owner is responsible for having the sprinklers inspected and tested according to standards of the applicable approval body and to the requirements of the Authority Having Jurisdiction to maintain proper operating condition of the system.

- **Sprinklers must be inspected on a regular basis for corrosion, mechanical damage, obstructions, paint, etc. Frequency of inspections may vary due to corrosive atmospheres, water supplies, and activity around the sprinkler.**

The applicable approval body or Authority Having Jurisdiction may require sprinklers to be replaced after a specified term of service.

- **Refer to the standards of the applicable approval body, such as NFPA, FM, VdS, or LPCB, and the requirements of the Authority Having Jurisdiction for detailed inspection, testing and replacements requirements.**

Sprinklers removed from the system for testing or for any other purpose must be replaced according to section 4.

4. REMOVAL AND REPLACEMENT

⚠ WARNING

Removal and replacement of sprinklers by insufficiently qualified personnel poses the risk of fatal consequences in case of fire.

- **Removal or replacement of sprinklers must be performed by qualified personnel familiar with safe practices and applicable and recognized design and installation standards issued, for example, by NFPA, FM, VdS, or LPCB, and trained how to properly perform the installation procedures.**

⚠ WARNING

Removal and replacement of sprinklers will temporarily eliminate the fire protection capabilities of the sprinkler system.

- **Consider the employment of a fire patrol in the affected area.**
- **Prior to proceeding, notify all Authorities Having Jurisdiction.**

⚠ WARNING

Re-installation of a removed sprinkler may compromise the operational safety of the sprinkler system.

- **NEVER** reinstall a removed sprinkler.
 - **ALWAYS** use new sprinklers for replacement.
1. Select new sprinklers with identical performance characteristics as well as respective accessories, such as escutcheons, cover plates, and protective caps. A stocked spare sprinkler cabinet may be provided for this purpose on site.
 2. According to appropriate system description and/or valve instructions, remove the system from service, drain all water, and relieve all pressure on the piping.
 3. Only for flush and concealed style sprinklers: Remove the ceiling ring or cover plate assembly of the old sprinkler by gently unthreading or pulling it off the sprinkler body (depends on the sprinkler model used).
 4. Use the proper sprinkler wrench for the old sprinkler according to its Technical Data Sheet.
 5. Only for flush and concealed style sprinklers, but not for domed concealed sprinklers: Replace the plastic protective cap over the old sprinkler and fit the wrench over the cap.
 6. Use the wrench to remove the old sprinkler by turning it counterclockwise to unthread it from the piping.
 7. Install the new sprinkler by following its Handling and Installation Instructions.
 8. Place the system back in service and secure all valves.
 9. Check for and repair all leaks.

5. DISPOSAL

At end of use the product described here should be disposed of via the national recycling system.

6. CONTACT

The sprinkler and accessories are available through Viking distributors only. Contact your local Viking sales office which can be found on our website:

Americas and Asia: www.vikinggroupinc.com/locations OR Europe, Middle East, Africa (EMEA): www.viking-emea.com/contact

Manufacturer:

The Viking Corporation
5150 Beltway SE
Caledonia, MI 49316
Tel.: (800) 968-9501
Fax: 269-818-1680
Technical Services: 1-877-384-5464
techsvcs@vikingcorp.com

Importer EU:

Viking S.A.
21, Z.I, Haneboesch
L-4562 Differdange / Nieder Korn
Tel.: +352 58 37 37 – 1
Fax: +352 58 37 36
vikinglux@viking-emea.com

Asia Pacific (APAC) Main Office:

The Viking Corporation (Far East) Pte. Ltd.
69 Tuas View Square
Westlink Techpark, Singapore 637621
Tel: (+65) 6 278 4061
Fax: (+65) 6 278 4609
vikingAPAC@vikingcorp.com