



**Section N**  
**Deluge Systems**

**TABLE OF CONTENTS**

Deluge System – Pneumatic Release ..... N-1 – N-2  
Deluge System – Hydraulic Release..... N-3 – N-4  
Deluge System – Electric Release..... N-5 – N-6  
Components and Accessories (general) ..... N-7  
Accessories (Pneumatic Release) ..... N-8  
Accessories (Hydraulic Release) ..... N-8  
Accessories (Electric Release) ..... N-9  
Alarm Devices..... N-10  
Special Valves and Trim ..... N-11 – N-12  
Deluge Valve Model VXD ..... N-13

**Notes**

1. Refer to Viking technical data pages for complete product specifications. You may print or download technical data by visiting [www.vikinggroupinc.com](http://www.vikinggroupinc.com).
2. List prices effective May 10, 2025. Supersedes July 2022 list price book.
3. All sales by Viking are subject to the terms & conditions found on the last page of this book.

**Deluge System - Pneumatic Release**

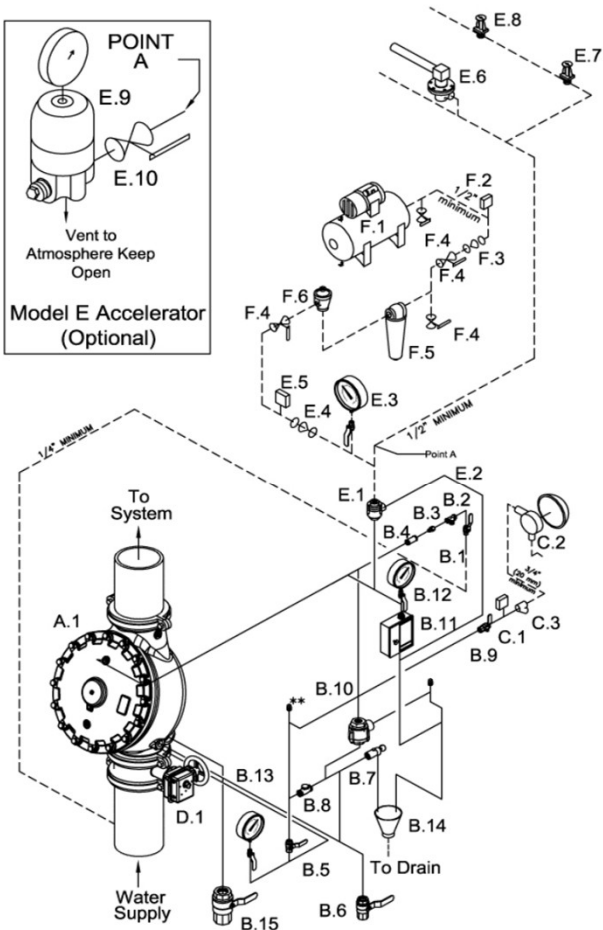

- SYSTEM COMPONENTS**
- A. Valve
    - A.1 Deluge Valve
  - B. Deluge Valve Conventional Trim \*
    - (See Deluge Valve Conventional Trim Charts)
    - B.1 Priming Valve (Normally Open)
    - B.2 Strainer
    - B.3 1/16" Restriction
    - B.4 Spring Loaded Check Valve
    - B.5 Alarm Test Valve (Normally Closed)
    - B.6 Auxiliary Drain Valve (Normally Closed)
    - B.7 Drip Check Valve
    - B.8 Drain Check Valve
    - B.9 Alarm Shut-Off Valve (Normally Open)
    - B.10 Pressure Operated Relief Valve (P.O.R.V.)
    - B.11 Emergency Release
    - B.12 Priming Pressure Water Gauge and Valve
    - B.13 Water Supply Pressure Gauge and Valve
    - B.14 Drain cup
    - B.15 Flow Test Valve (Normally Closed)
  - C. Water Flow Alarm Equipment
    - C.1 Alarm Pressure Switch and/or
    - C.2 Water Motor Alarm (Strainer Required)
    - C.3 Strainer
  - D. Riser
    - D.1 Water Supply Control Valve
  - E. Release System
    - E.1 Pneumatic Actuator
    - E.2 Pneumatic Release Module  
(See Pneumatic Release Module Trim Chart)
    - E.3 Air Pressure Gauge and Valve
    - E.4 Soft Seat Check Valve
    - E.5 Air Pressure Supervisory Switch
    - E.6 Thermostatic Release and/or
    - E.7 Fixed Temperature Release and/or
    - E.8 Pilot Head (Sprinkler)
    - E.9 Accelerator (Optional. See Inset.)
    - E.10 Accelerator Isolation Valve. (See Inset.)
  - F. Air Supply
    - F.1 Automatic Air Supply, Air Compressor and Tank shown for clarity.
    - F.2 Air Supervisory Pressure Switch (Compressor On/Off Control Switch)
    - F.3 Soft Seat Check Valve
    - F.4 Shut Off Valve (Indicating Ball Valve recommended.)
    - F.5 Dehydrator
    - F.6 Air maintenance Device & By-Pass Trim
- Dashed lines indicate pipe required but not included with Deluge Valve Conventional Trim Packages.
- \* Viking Deluge Valve Trim Packages contain items B.1 through B.15 and associated nipples.  
Viking Accessory Package for Conventional Deluge Valve Trim contains B.2 through B.5, B.7 through B.11, and B.14.
- \*\* 1/2" (15 mm) NPT for Non-Interruptable Alarm Pressure Switch (Optional)

Above components are included in QuikPik packages as customized by user. See page N-2

**Model F Deluge / Preaction Valve\* - STRAIGHT THROUGH**

V233	1-1/2"	2"	2-1/2"	3"	4"	6"	8"
Thread X Thread	12126 \$4,781.59	12059 \$4,942.18	12401 \$6,526.22	N/A	N/A	N/A	N/A
Flange X Flange	N/A	N/A	N/A	12014 \$6,526.22	11953 \$8,501.01	11955 \$11,627.84	11991 \$26,338.47
Flange X Groove	N/A	N/A	N/A	12018 \$6,526.22	11952 \$8,501.01	11954 \$11,627.84	N/A
Groove X Groove	12125 \$4,781.59	12057 \$4,942.18	12403 \$6,526.22	12022 \$6,526.22	11513 \$8,501.01	11524 \$11,627.84	11018 \$26,338.47

See page N-11/12 for additional valve and trim options, including Halar® coated valves, horizontal trim, and brass trim packages.

\* Valve is not included in trim packages. Please order separately. See following page for trim packages and equipment.

**Deluge System - Pneumatic Release**

TrimPac®	V234	1-1/2"	2"	2-1/2"	3"	4"	6"	8"
Straight-Through		<u>13788B-2</u>	<u>13788B-2</u>	<u>13788B-2</u>	<u>13788B-2</u>	<u>13788B-2</u>	<u>13788B-2</u>	<u>13788B-2</u>
		\$8,337.72	\$8,337.72	\$8,337.72	\$8,337.72	\$8,337.72	\$8,337.72	\$8,337.72

TrimPac® includes conventional trim, releasing device (pneumatic actuator), releasing trim, and flexible hose kit.  
Drain package for TrimPac® must be ordered separately (see below).

**Drain Package (IPG V257)**

Use with TrimPac®		11894-1	11894-2	11894-3	11894-3	11894-4	11894-4	11894-4
(order separately)		\$876.54	\$709.00	\$803.47	\$803.47	\$1,031.22	\$1,031.22	\$1,031.22

1-1/2"	2"	2-1/2"	3"	4"	6"	8"
--------	----	--------	----	----	----	----

**Trim (Vertical - Straight Through Valve) - Galvanized (IPG V236)**

Loose Trim <i>(incl. accessory pkg-09316)</i>	<u>14634-1</u>	<u>14634-1</u>	<u>14636-1</u>	<u>14636-1</u>	<u>14639-1</u>	<u>14641-1</u>	<u>14642-1</u>
	\$5,329.24	\$5,329.24	\$5,215.35	\$5,215.35	\$5,457.32	\$5,470.13	\$7,923.71
Modular Trim <i>(incl. accessory pkg-09316)</i>	<u>14634-1P</u>	<u>14634-1P</u>	<u>14636-1P</u>	<u>14636-1P</u>	<u>14639-1P</u>	<u>14641-1P</u>	<u>14642-1P</u>
	\$5,810.40	\$5,810.40	\$5,696.46	\$5,696.46	\$5,940.73	\$5,953.48	\$8,407.08

**Trim (Vertical - Angle Style Valve) - Galvanized (IPG V236)**

Loose Trim <i>(incl. accessory pkg-09316)</i>	<u>14629-1</u>	<u>14630-1</u>	N/A	<u>14631-1</u>	<u>14632-1</u>	<u>14633-1</u>	N/A
	\$5,580.62	\$5,371.53		\$5,461.35	\$5,714.81	\$5,728.14	
Modular Trim <i>(incl. accessory pkg-09316)</i>	<u>14629-1P</u>	<u>14630-1P</u>	N/A	<u>14631-1P</u>	<u>14632-1P</u>	<u>14633-1P</u>	N/A
	\$6,061.76	\$5,852.69		\$5,942.50	\$6,195.92	\$6,209.31	

1-1/2"	2"	2-1/2"	3"	4"	6"	8"
--------	----	--------	----	----	----	----

**Releasing Devices (IPG V226)**

Pneumatic Actuator	<u>06459B</u>	<u>06459B</u>	<u>06459B</u>	<u>06459B</u>	<u>06459B</u>	<u>06459B</u>	<u>06459B</u>
	\$1,029.29	\$1,029.29	\$1,029.29	\$1,029.29	\$1,029.29	\$1,029.29	\$1,029.29

**Releasing Trim - Galvanized (IPG V238)**

Loose Trim <i>(releasing device not incl.)</i>	<u>10809</u>	<u>10809</u>	<u>10809</u>	<u>10809</u>	<u>10809</u>	<u>10809</u>	<u>10809</u>
	\$161.27	\$161.27	\$161.27	\$161.27	\$161.27	\$161.27	\$161.27
Modular Trim <i>(releasing device not incl.)</i>	<u>10809P</u>	<u>10809P</u>	<u>10809P</u>	<u>10809P</u>	<u>10809P</u>	<u>10809P</u>	<u>10809P</u>
	\$718.70	\$718.70	\$718.70	\$718.70	\$718.70	\$718.70	\$718.70
Loose Trim-DOMESTIC <sup>1</sup> <i>(releasing device not incl.)</i>	<u>10809USA</u>	<u>10809USA</u>	<u>10809USA</u>	<u>10809USA</u>	<u>10809USA</u>	<u>10809USA</u>	<u>10809USA</u>
	\$215.03	\$215.03	\$215.03	\$215.03	\$215.03	\$215.03	\$215.03

Trim packages includes deluge valve accessory package (p/n 09316) - See page N-7 for package detail.  
See pages N-11/N-12 for additional valve and trim options, including Halar® coated valves, domestic trim, horizontal trim, brass trim packages.

Deluge System - Hydraulic Release

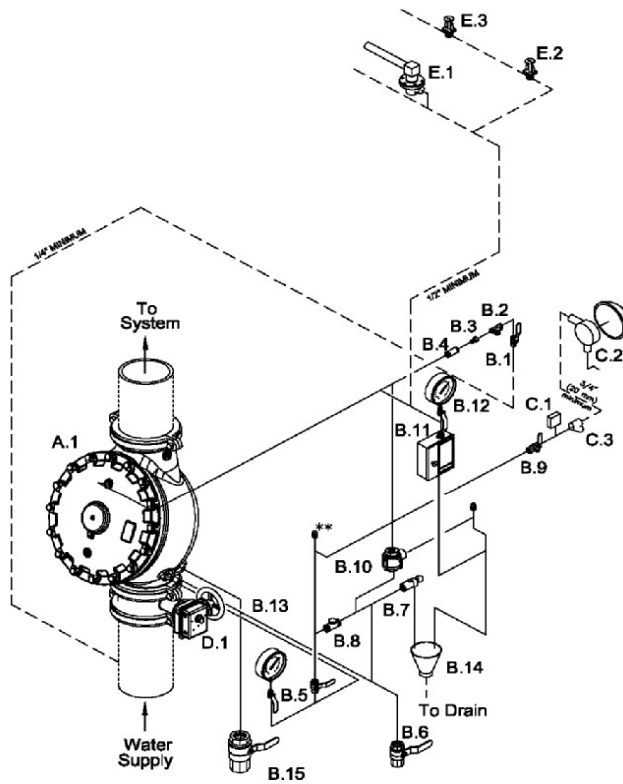

----- Dashed lines indicate pipe required but not included with Deluge Valve Conventional Trim Packages.

\* Viking Deluge Valve Trim Packages contain items B.1 through B.15 and associated nipples. Viking Accessory Package for Conventional Deluge Valve Trim contains B.2 through B.5, B.7 through B.11, and B.14.

\*\* 1/2" (15 mm) NPT for Non-interruptible Alarm Pressure Switch (Optional)

SYSTEM COMPONENTS

- A. Valve
  - A.1 Deluge Valve
- B. Deluge Valve Conventional Trim \*  
(See Deluge Valve Conventional Trim Charts)
  - B.1 Priming Valve (Normally Open)
  - B.2 Strainer
  - B.3 1/16" Restriction
  - B.4 Spring Loaded Check Valve
  - B.5 Alarm Test Valve (Normally Closed)
  - B.6 Auxiliary Drain Valve (Normally Closed)
  - B.7 Drip Check Valve
  - B.8 Drain Check Valve
  - B.9 Alarm Shut-Off Valve (Normally Open)
  - B.10 Pressure Operated Relief Valve (P.O.R.V.)
  - B.11 Emergency Release
  - B.12 Priming Pressure Water Gauge and Valve
  - B.13 Water Supply Pressure Gauge and Valve
  - B.14 Drain cup
  - B.15 Flow Test Valve (Normally Closed)
- C. Water Flow Alarm Equipment
  - C.1 Alarm Pressure Switch and/or
  - C.2 Water Motor Alarm (Strainer Required)
  - C.3 Strainer
- D. Riser
  - D.1 Water Supply Control Valve
- E. Release System
  - E.1 Thermostatic Release and/or
  - E.2 Fixed Temperature Release and/or
  - E.3 Pilot Head (Sprinkler)

CAUTION

DO NOT EXCEED MAXIMUM HEIGHT ALLOWED FOR THE HYDRAULIC RELEASE PIPING ABOVE THE DELUGE VALVE.

FOR MAXIMUM HEIGHT ALLOWED, REFER TO CURRENT TECHNICAL DATA DESCRIBING THE VIKING DELUGE VALVE USED.

Components shown above are included in Quik Pik packages as customized by user. See page N-4.

**Model F Deluge / Preaction Valve\* - STRAIGHT THROUGH**

V233	1-1/2"	2"	2-1/2"	3"	4"	6"	8"
Thread X Thread	<u>12126</u> \$4,781.59	<u>12059</u> \$4,942.18	<u>12401</u> \$6,526.22	N/A	N/A	N/A	N/A
Flange X Flange	N/A	N/A	N/A	<u>12014</u> \$6,526.22	<u>11953</u> \$8,501.01	<u>11955</u> \$11,627.84	<u>11991</u> \$26,338.47
Flange X Groove	N/A	N/A	N/A	<u>12018</u> \$6,526.22	<u>11952</u> \$8,501.01	<u>11954</u> \$11,627.84	N/A
Groove X Groove	<u>12125</u> \$4,781.59	<u>12057</u> \$4,942.18	<u>12403</u> \$6,526.22	<u>12022</u> \$6,526.22	<u>11513</u> \$8,501.01	<u>11524</u> \$11,627.84	<u>11018</u> \$26,338.47

See page N-11/12 for additional valve and trim options, including Halar® coated valves, horizontal trim, and brass trim packages.

\* Valve is not included in trim packages. Please order separately. See following page for trim packages and equipment.



**Deluge System - Hydraulic Release**

	1-1/2"	2"	2-1/2"	3"	4"	6"	8"
<b>Trim (Vertical - Straight Through Valve) - Galvanized (IPG V236)</b>							
<u>Loose Trim</u>	<u>14634-1</u>	<u>14634-1</u>	<u>14636-1</u>	<u>14636-1</u>	<u>14639-1</u>	<u>14641-1</u>	<u>14642-1</u>
<i>(incl. accessory pkg-09316)</i>	\$5,329.24	\$5,329.24	\$5,215.35	\$5,215.35	\$5,457.32	\$5,470.13	\$7,923.71
<u>Modular Trim</u>	<u>14634-1P</u>	<u>14634-1P</u>	<u>14636-1P</u>	<u>14636-1P</u>	<u>14639-1P</u>	<u>14641-1P</u>	<u>14642-1P</u>
<i>(incl. accessory pkg-09316)</i>	\$5,810.40	\$5,810.40	\$5,696.46	\$5,696.46	\$5,940.73	\$5,953.48	\$8,407.08

Trim packages includes deluge valve accessory package (p/n 09316) - See page N-7 for package detail.

See pages N-11/12 for additional valve and trim options, including Halar® coated valves, horizontal trim, domestic trim, and brass trim packages.

**Deluge System - Electric Release**

Straight-through valve shown.

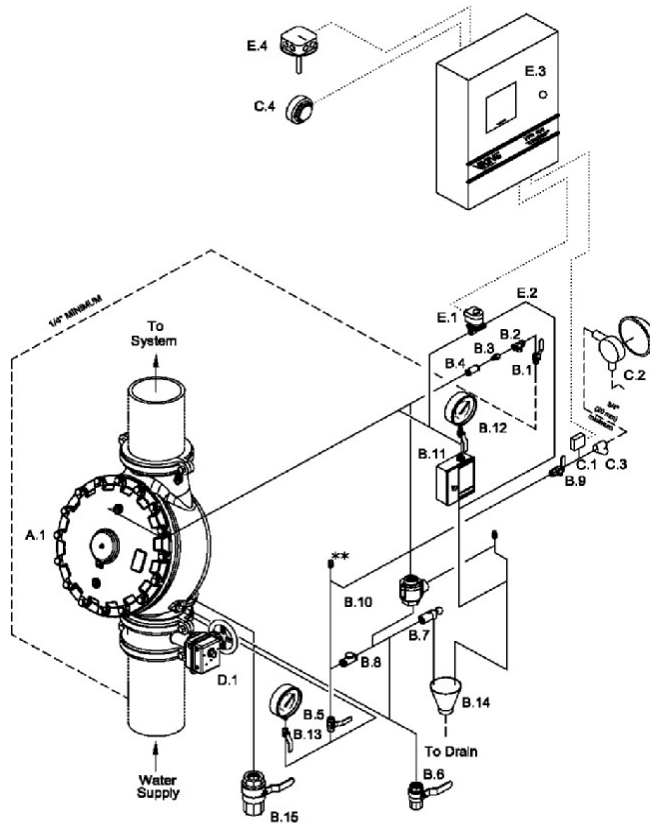

**SYSTEM COMPONENTS**

- A. Valve**
  - A.1 Deluge Valve
- B. Deluge Valve Conventional Trim \***  
(See Deluge Valve Conventional Trim Charts)
  - B.1 Priming Valve
  - B.2 Strainer
  - B.3 1/16" Restricted Orifice
  - B.4 Spring Loaded Check Valve
  - B.5 Alarm Test Valve (Normally Closed)
  - B.6 Auxiliary Drain Valve (Normally Closed)
  - B.7 Drip Check Valve
  - B.8 Drain Check Valve
  - B.9 Alarm Shut-Off Valve (Normally Open)
  - B.10 Pressure Operated Relief Valve (P.O.R.V.)
  - B.11 Emergency Release
  - B.12 Priming Pressure Water Gauge and Valve
  - B.13 Water Supply Pressure Gauge and Valve
  - B.14 Drain Cup
  - B.15 Flow Test Valve (Normally Closed)
- C. Water Flow Alarm Equipment**
  - C.1 Alarm Pressure Switch and/or
  - C.2 Water Motor Alarm (Strainer Required)
  - C.3 Strainer
  - C.4 Electric Alarm Bell
- D. Riser**
  - D.1 Water Supply Control Valve
- E. Release System**
  - E.1 Solenoid Valve
  - E.2 Electric Release Module Trim
  - E.3 System Control Panel configured for Single Zone Deluge operation.
  - E.4 Electric Detection System. Heat Detector shown for clarity.

Dashed lines indicate pipe required but not listed in "System Components" Table.

\* Viking Deluge Valve Trim Packages contain items B.1 through B.15 and associated nipples. Viking Accessory Package for Conventional Deluge Valve Trim contains B.2 through B.5, B.7 through B.11, and B.14.

Dotted lines indicate electrical detection system wiring required but not listed in "System Components" Table. For additional wiring requirements refer to technical data for components used.

Components shown above are included in Quik Pik packages as customized by user. See page N-6.

**Model F Deluge / Preaction Valve\* - STRAIGHT THROUGH**

V233	1-1/2"	2"	2-1/2"	3"	4"	6"	8"
Thread X Thread	<u>12126</u> \$4,781.59	<u>12059</u> \$4,942.18	<u>12401</u> \$6,526.22	N/A	N/A	N/A	N/A
Flange X Flange	N/A	N/A	N/A	<u>12014</u> \$6,526.22	<u>11953</u> \$8,501.01	<u>11955</u> \$11,627.84	<u>11991</u> \$26,338.47
Flange X Groove	N/A	N/A	N/A	<u>12018</u> \$6,526.22	<u>11952</u> \$8,501.01	<u>11954</u> \$11,627.84	N/A
Groove X Groove	<u>12125</u> \$4,781.59	<u>12057</u> \$4,942.18	<u>12403</u> \$6,526.22	<u>12022</u> \$6,526.22	<u>11513</u> \$8,501.01	<u>11524</u> \$11,627.84	<u>11018</u> \$26,338.47

See page N-11/12 for additional valve and trim options, including Halar® coated valves, horizontal trim, and brass trim packages.

\* Valve is not included in trim packages. Please order separately. See following page for trim packages and equipment.

**Deluge System - Electric Release**

TrimPac® IPG V234	1-1/2"	2"	2-1/2"	3"	4"	6"	8"
<u>Straight-Through</u>	<u>13787B-1</u>	<u>13787B-1</u>	<u>13787B-1</u>	<u>13787B-1</u>	<u>13787B-1</u>	<u>13787B-1</u>	<u>13787B-1</u>
	\$8,490.86	\$8,490.86	\$8,490.86	\$8,490.86	\$8,490.86	\$8,490.86	\$8,490.86
<u>Straight-Through</u> <i>With Monitored Solenoid</i>	<u>28197B-1</u>	<u>28197B-1</u>	<u>28197B-1</u>	<u>28197B-1</u>	<u>28197B-1</u>	<u>28197B-1</u>	<u>28197B-1</u>
	\$9,329.98	\$9,329.98	\$9,329.98	\$9,329.98	\$9,329.98	\$9,329.98	\$9,329.98
<u>Straight-Through</u> <i>Monitored Solenoid Brass</i>	<u>28197B-1B</u>	<u>28197B-1B</u>	<u>28197B-1B</u>	<u>28197B-1B</u>	<u>28197B-1B</u>	<u>28197B-1B</u>	<u>28197B-1B</u>
	\$10,522.63	\$10,522.63	\$10,522.63	\$10,522.63	\$10,522.63	\$10,522.63	\$10,522.63

TrimPac® includes conventional trim, releasing device (solenoid valve), releasing trim, and flexible hose kit.  
Drain package for TrimPac® must be ordered separately (see below).

**Drain Package (IPG V257)**

<u>Use with TrimPac®</u> <i>(order separately)</i>	<u>11894-1</u>	<u>11894-2</u>	<u>11894-3</u>	<u>11894-3</u>	<u>11894-4</u>	<u>11894-4</u>	<u>11894-4</u>
	\$876.54	\$709.00	\$803.47	\$803.47	\$1,031.22	\$1,031.22	\$1,031.22

1-1/2"	2"	2-1/2"	3"	4"	6"	8"
--------	----	--------	----	----	----	----

**Trim (Vertical - Straight Through Valve) - Galvanized (IPG V236)**

<u>Loose Trim</u> <i>(incl. accessory pkg-09316)</i>	<u>14634-1</u>	<u>14634-1</u>	<u>14636-1</u>	<u>14636-1</u>	<u>14639-1</u>	<u>14641-1</u>	<u>14642-1</u>
	\$5,329.24	\$5,329.24	\$5,215.35	\$5,215.35	\$5,457.32	\$5,470.13	\$7,923.71
<u>Modular Trim</u> <i>(incl. accessory pkg-09316)</i>	<u>14634-1P</u>	<u>14634-1P</u>	<u>14636-1P</u>	<u>14636-1P</u>	<u>14639-1P</u>	<u>14641-1P</u>	<u>14642-1P</u>
	\$5,810.40	\$5,810.40	\$5,696.46	\$5,696.46	\$5,940.73	\$5,953.48	\$8,407.08

**Trim (Vertical - Angle Style Valve) - Galvanized (IPG V236)**

<u>Loose Trim</u> <i>(incl. accessory pkg-09316)</i>	<u>14629-1</u>	<u>14630-1</u>	<b>N/A</b>	<u>14631-1</u>	<u>14632-1</u>	<u>14633-1</u>	<b>N/A</b>
	\$5,580.62	\$5,371.53		\$5,461.35	\$5,714.81	\$5,728.14	
<u>Modular Trim</u> <i>(incl. accessory pkg-09316)</i>	<u>14629-1P</u>	<u>14630-1P</u>	<b>N/A</b>	<u>14631-1P</u>	<u>14632-1P</u>	<u>14633-1P</u>	<b>N/A</b>
	\$6,061.76	\$5,852.69		\$5,942.50	\$6,195.92	\$6,209.31	

1-1/2"	2"	2-1/2"	3"	4"	6"	8"
--------	----	--------	----	----	----	----

**Releasing Devices (IPG V240)**

<u>Solenoid Valve</u>	<u>11601</u>	<u>11601</u>	<u>11601</u>	<u>11601</u>	<u>11601</u>	<u>11601</u>	<u>11601</u>
	\$1,597.55	\$1,597.55	\$1,597.55	\$1,597.55	\$1,597.55	\$1,597.55	\$1,597.55
<u>Monitored Solenoid Valve</u>	<u>26785</u>	<u>26785</u>	<u>26785</u>	<u>26785</u>	<u>26785</u>	<u>26785</u>	<u>26785</u>
	\$2,907.10	\$2,907.10	\$2,907.10	\$2,907.10	\$2,907.10	\$2,907.10	\$2,907.10

**Releasing Trim - Galvanized (IPG V238)**

<u>Loose Trim</u> <i>(releasing device not incl.)</i>	<u>10830</u>	<u>10830</u>	<u>10830</u>	<u>10830</u>	<u>10830</u>	<u>10830</u>	<u>10830</u>
	\$166.50	\$166.50	\$166.50	\$166.50	\$166.50	\$166.50	\$166.50
<u>Modular Trim</u> <i>(releasing device not incl.)</i>	<u>10830P</u>	<u>10830P</u>	<u>10830P</u>	<u>10830P</u>	<u>10830P</u>	<u>10830P</u>	<u>10830P</u>
	\$718.70	\$718.70	\$718.70	\$718.70	\$718.70	\$718.70	\$718.70
<u>Loose Trim-DOMESTIC<sup>1</sup></u> <i>(releasing device not incl.)</i>	<u>10830USA</u>	<u>10830USA</u>	<u>10830USA</u>	<u>10830USA</u>	<u>10830USA</u>	<u>10830USA</u>	<u>10830USA</u>
	\$221.96	\$221.96	\$221.96	\$221.96	\$221.96	\$221.96	\$221.96

Trim packages includes deluge valve accessory package (p/n 09316) - See page N-7 for package detail.

See pages N-11/N-12 for additional valve and trim options, including Halar® coated valves, horizontal trim, domestic trim, and brass trim packages.

**Accessories and Additional Components**

**Deluge Valve Accessory Package**

(included with deluge/preaction trim)

Includes:

- 1/16" Restricted Orifice Galvanized
- Emergency Release 09316
- Drip Check \$3,683.77
- 1/4" / 8mm Check Valve
- 1/4" / 8mm Strainer Stainless Steel \*
- Drain Cup 09743
- PORV \$5,137.86
- Drain Check \* Does not include PORV
- 1/2" Ball Valve IPG V226

**Pressure Operated Relief Valve (PORV) - Model D-3**



1/2" / DN15  
Brass  
16970 \$2,403.04

IPG V242

**Pressure Operated Relief Valve (PORV) - Model D-4**



1/2" / DN15  
Corrosion Resistant  
16971 \$3,696.98

IPG V242

**Globe Valve for Gauges (side outlet)**



1/4" / DN8  
76V-25 \$24.67

**Restricted Orifice**

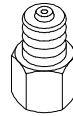

1/4" (DN8)  
1/16" (1.6mm) 10110 \$62.22

Corrosion Resistant  
1/16" (1.6mm) 10110J \$145.03

IPG V226

**Ball Valve**

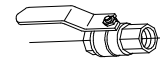

IPG V226

<u>Brass</u>			
1/4"	10354USA	\$74.68	
1/2"	10355USA	\$76.90	
1"	10356	\$106.25	

<u>Stainless Steel</u>	
10644	\$442.24
10645	\$444.76
10646	\$709.40
10647	\$859.91
10648	\$1,639.1
10649	\$2,224.9

**Drain Check Valve**

IPG V226

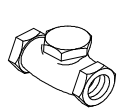

1/2" / DN15  
05781A \$160.03  
Corrosion Resistant  
05781AJ \$334.79

**Drain Cup**



1 1/2" / DN40  
01019B \$30.80

IPG V226

**Emergency Release**

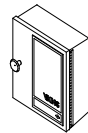

<u>1/2" (Galvanized)</u>		<u>Brass</u>		<u>Corrosion Resistant</u>	
<u>Model C-1</u>		<u>Model C-2</u>		<u>Model C-3</u>	
01553C	\$614.74	09387	\$1,025.43	09734	\$1,258.05

IPG V226

**Prime Shut-Off Valve**

IPG V226

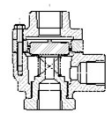

1/2" / DN15  
10723 \$1,361.58  
Corrosion Resistant  
10724 \$2,433.74

**Drip Check Valve - Model D-1**

**Velocity Check**



IPG V25.1

3/4" / DN20  
10730 \$314.48  
Corrosion Resistant  
10733 \$474.35

**Water Gauge**



0-300 psi  
1/4" VWATERSF \$31.27

**In-Line Check Valve**

IPG V226

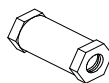

1/4" / DN8  
04947A \$148.86

**Y Strainer**



1/4" / DN15  
14BYS \$43.22

IPG SR260

**Restricted Orifice**

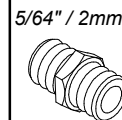

5/64" / 2mm  
1/2" / DN15  
11706 \$128.52

IPG V226

**Air Line Trim**

(not for use with Deluge TrimPac System)

Tank Mounted 13770 \$2,932.66  
Tankless 13771 \$1,858.06

IPG V234

**Replacement Hose**

PVC drain hose 12071 \$233.57

IPG V234

**Riser Mounting Kit**

(when mounting TrimPac to riser)

Vertical 11900 \$1,621.97  
Horizontal 11901 \$2,230.32

IPG V234

**Accessories for Old Style Trim**

**Model A-2 Strainer Orifice Check Vlv**

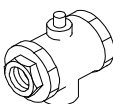

1/4" (DN8)  
06579B \$584.48

IPG V226

**Alarm Test/Alarm Shut-Off Valve**

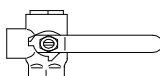

1/2" (DN15)  
06174A \$629.32

IPG V226

**Spring Loaded Check Valve**

(with viton disc)

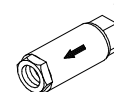

1/2" (DN15)  
12WILC \$289.70

SR140



**Accessories for Pneumatic Release Systems**

**Pneumatic Actuator**



1/2" (DN15)  
Model H-1  
06459B \$1,029.29  
Corrosion Resistant (Model R-1)  
09733 \$2,322.05  
IPG V226

**Model D-2 - Air Pressure Maintenance Device**



Size	Part #	List Price
1/2" / DN15	07459	\$2,135.55

**DOMESTIC**

Size	Part #	List Price
1/2" / DN15	07459US	\$2,847.38

**Model D-2 - Air Pressure Maintenance Device**

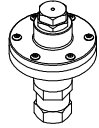

Size	Part #	List Price
1/4" / DN8	02280C	\$1,215.26

IPG V226

**Replacement Restriction**  
Release Line Air Supply



Part #	List Price
02902B	\$294.44

IPG V226

**Dehydrator Package** \*one unit fills dehydrator

Includes: 1/4" (DN8)

- Desiccant 16854 \$2,875.36
- Mounting Brackets Extra Desiccant\*
- Nipples 16855 \$651.03

IPG V226

**Accessories for Pneumatic and Hydraulic Systems**

**Thermostatic Release (Model C-1)**  
(Includes 155°F/68°C fixed temperature release)



- indoor and outdoor use Standard 01432C \$2,722.50
- Nitrogen Tested 05006A \$2,932.80

IPG V226

**Thermostatic Release (Model C-2)**  
(Includes 155°F/68°C fixed temperature release)

- indoor and outdoor use Standard 03991C-18 \$3,239.70
- corrosion resistant Nitrogen Tested 10367 \$3,450.02

environments

IPG V226

**Operation Indicator**

Includes: 1/2" (DN15)

- indoor and outdoor use 02944A \$106.81
- corrosion resistant

IPG V226

**Adjustment Kit**



Includes:

- indoor and outdoor use
- corrosion resistant

Model C-1 and C-2  
01714A \$325.50

IPG V226

**Fixed Temperature Release (Model M HP - VK800)**  
1/2" (15 mm) - RATED TO 250 PSI (1724 kPa) IPG V226



Material	Part #	List Price
Brass	07848AB	\$86.36
Chrome	07848FA	\$92.58
White	07848MA/W	\$92.58

Add the temperature suffix to the part number (135 shown):  
(°F/°C) A=135°/57°, B=155°/68°, D=175°/79°, E=200°/93°, G=286°/141°

**Replacement Fixed Temperature Release**  
155°F/68°C



Model	Part #	List Price
Model C-1	07848FB	\$92.58
Model C-2	07848CB	\$110.38

IPG V226

**Release Line Hangers** - includes two screws/nuts IPG V226

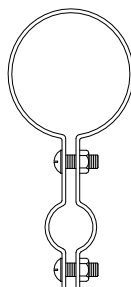





Size in/DN	1/2"		1"	
	Part #	List Price	Part #	List Price
1" / DN25	09574	\$36.37	25660	\$36.37
1 1/4" / DN32	09575	\$36.37	25661	\$36.37
1 1/2" / DN40	09576	\$36.37	25662	\$36.37
2" / DN50	09577	\$36.37	25663	\$36.37
2 1/2" / DN65	09578	\$36.37	25664	\$36.37
3" / DN80	09579	\$36.37	25665	\$36.37

Size in/DN	1/2"		1"	
	Part #	List Price	Part #	List Price
3 1/2" / DN90	09580	\$36.37	25666	\$36.37
4" / DN100	09581	\$53.18	25667	\$53.18
5" / DN125	09582	\$53.18	25668	\$53.18
6" / DN150	09583	\$53.18	25669	\$53.18
8" / DN200	09584	\$53.18	25670	\$53.18

Stainless steel available upon request at additional cost. Add suffix "SST" to base part number.



**Accessories for Electric Release Systems**

SOLENOID VALVES (1/2" / DN15)		IPG V240	
<b>Normally Closed (rated to 250 psi (1724 kPa))</b>			
	<u>Deluge &amp; Preaction, SureFire</u>		
	NEMA 1,2,3,3S,4,4X	24 VDC	11601 \$1,597.55
	<u>Explosion Proof</u>		
	NEMA 3,3S,4,4X,6,6P,7,9	24 VDC	11602 \$2,669.90
<b>Normally Closed (rated to 300 psi (2068 kPa))</b>			
	<u>Firecycle III, TotalPac &amp; Special Application</u>		
	NEMA 2,3,3S,4,4X	24 VDC	11591 \$2,039.72
	NEMA 1,2,3,3S,4,4X	110 VAC/50 HZ	11593 \$1,735.66
	NEMA 1,2,3,3S,4,4X	120 VAC/60 HZ	11594 \$2,360.32
	<u>Explosion Proof</u>		
	NEMA 3,3S,4,4X,6,6P,7,9	24 VDC	11592 \$2,669.90
	NEMA 3,3S,4,4X,6,6P,7,9	110 VAC/50 HZ	11594 \$2,360.32
	NEMA 3,3S,4,4X,6,6P,7,9	120 VAC/60 HZ	11594 \$2,360.32
	ATEX, EEx, mII, T4/T5	110 VAC/50 HZ	12359 \$2,802.46
	ATEX, EEx, mII, T4/T5	24 VDC	12360 \$3,112.07
<b>Normally Open (rated to 300 psi (2068 kPa))</b>			
	<u>Firecycle III</u>		
	NEMA 2,3,3S,4,4X	24 VDC	11595 \$3,394.02
	<u>Surefire &amp; TrimPac</u>		
	NEMA 2,3,3S,4,4X	24 VDC	13215 \$3,394.02
	<u>Explosion Proof</u>		
	NEMA 3,3S,4,4X,6,6P,7,9	24 VDC	11596 \$4,731.68
	ATEX, EEx, mII, T4/T5	24 VDC	12358 \$5,173.77

RELEASE CONTROL PANEL (VFR-500)		IPG V241	
<b>VFR-500 Release Control Panel</b>			
<ul style="list-style-type: none"> <li>- Contains seven user-definable zones &amp; menu-driven programming control</li> <li>- Up to 35 standard programs in memory and programmable cross-zoning</li> <li>- Multi-directional navigation through the panel history and menus</li> <li>- cULus Listed and FM Approved for agent and/or water-based extinguishing</li> </ul> <p>* see below for accessories and optional modules</p>	<u>Part No.</u>	<u>List Price</u>	
	26107	\$6,650.15	
<b>Optional Modules / Accessories</b>	<u>Part No.</u>	<u>List Price</u>	<b>Batteries</b> (two required per panel)
CA2Z Module (class A initiating device circuit):	14155	\$397.02	<u>Part No.</u> <u>List Price</u>
CAM2 Module (class A indicating appliance circuit):	14156	\$456.57	8 Amp 07920 P.O.A.
ARM-1 Module (auxiliary relay module):	14157	\$575.68	12 Amp 07921 P.O.A.
RA-4410-RC (remote annunciator):	26125	\$1,879.67	18 Amp 09867 P.O.A.
	<u>Part No.</u>	<u>List Price</u>	
MR-101/T SPDT Relay Module:	14159	\$233.29	
MR-201 DPDT Relay Module:	14160	\$292.79	
MR801/T SPDT Relay w/Led Indicator:	14161	\$124.07	
ELOD Resistor/Diode:	14162	\$59.55	
ELOR Resistor:	14163	\$10.36	

**Alarm Devices**

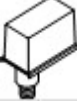
**Alarm Pressure Switch - IPG SR020**

<p><u>Factory-Set Range (4-8 psi)</u></p> <p><u>1/2" / DN50</u></p> <p>Single SPDT PS101A \$333.57</p> <p>Dual SPDT PS102A \$399.41</p> <p><i>* Manufactured by Potter</i></p> 	<p><u>Explosion Proof</u></p> <p>Dual SPDT PS10-EX \$2,330.63</p> <p>Dual SPDT PS40EX \$2,330.63</p> <p><u>Pressure Adj Access Key</u></p> <p>10600 \$45.62</p> <p><u>Cover Removal Key</u></p> <p>10601 \$45.62</p> 
--	--

\* Appropriate hex keys included with switches.

**Pressure Supervisory Switch (Air, Nitrogen, Water) - IPG SR020**





<p><u>Adjustable Range (10-60 psi)</u></p> <p><u>1/2" / DN50</u></p> <p>Single SPDT PS401A \$331.38</p> <p>Dual SPDT PS402A \$399.41</p> <p><i>* Manufactured by Potter</i></p>  <p><u>Cover Tamper Switch Kit</u></p> <p>09601 \$233.30</p>	<p><u>Explosion Proof</u></p> <p><u>Pressure Adj Access Key</u></p> <p>10600 \$45.62</p> <p><u>Cover Removal Key</u></p> <p>10601 \$45.62</p> 
---	---

\* Appropriate hex keys included with switches.

**Flow Switch - IPG SR010**

<p><u>Waterflow Indicators</u></p> <p>(adjustable retard up to 90 sec. - 2 SPDT contacts)</p> <p><u>Model VSR</u></p> <p>1-2" / DN40 VSRF0100 \$465.28</p> <p>2" / DN50 VSRF0200 \$497.44</p> <p>2½" / DN65 VSRF0250 \$497.44</p> <p>3" / DN80 VSRF0300 \$497.44</p> <p>3½" / DN90 VSRF0350 \$497.44</p> <p>4" / DN100 VSRF0400 \$497.44</p> <p>5" / DN125 VSRF0500 \$497.44</p> <p>6" / DN150 VSRF0600 \$497.44</p> <p>8" / DN200 VSRF0800 \$555.34</p> 
--

**Water Motor Alarm and Accessories - IPG V226**

<p><u>Water Motor Alarm</u></p>  <p><u>Model F-2</u></p> <p>07862 \$1,036.72</p>	<p><u>Closure Plate</u></p>  <p>05820B \$211.59</p>
<p><u>Adjustable Shaft</u></p> <p>(wall thickness up to 30-1/4 in / 768 mm)</p>  <p>03312B \$203.02</p>	<p><u>Alarm Line Y Strainer</u></p>  <p><u>3/4" (DN20)</u></p> <p>01489A \$308.71</p>
<p><u>Extension Cup</u></p>  <p>05957B \$169.28</p>	

**Special Valves and Trim**

**HALAR® Coated Deluge / Preaction Valves (Model F-2)**

**Straight-Through (Model F-2)**

IPG V233	1-1/2"	2"	2-1/2"	3"	4"	6"	8"
Thread X Thread	N/A	N/A	<u>12402Q/B</u> \$10,224.50	N/A	N/A	N/A	N/A
Flange X Flange	N/A	N/A	N/A	<u>12015Q/B</u> \$10,224.50	<u>11960Q/B</u> \$13,679.53	<u>11962Q/B</u> \$18,305.27	<u>11992Q/B</u> \$38,320.90
Flange X Groove	N/A	N/A	N/A	<u>12019Q/B</u> \$10,224.50	<u>11959Q/B</u> \$13,679.53	<u>11961Q/B</u> \$18,305.27	N/A
Groove X Groove	<u>12127Q/B</u> \$7,575.28	<u>12058Q/B</u> \$7,595.89	<u>12404Q/B</u> \$10,224.50	<u>12023Q/B</u> \$10,224.50	<u>11514Q/B</u> \$13,679.53	<u>11525Q/B</u> \$18,305.27	<u>11118Q/B</u> \$36,469.67

**HORIZONTAL TRIM - Conventional Deluge / Preaction Trim**

**Galvanized**

IPG V236	1-1/2"	2"	2-1/2"	3"	4"	6"	8"
Loose Trim <i>(incl. accessory pkg-09316)</i>	<u>14635-1</u> \$5,329.24	<u>14635-1</u> \$5,329.24	<u>14637-1</u> \$5,215.35	<u>14637-1</u> \$5,215.35	<u>14638-1</u> \$5,457.32	<u>14640-1</u> \$5,470.13	<u>14643-1</u> \$7,923.71
Modular Trim <i>(incl. accessory pkg-09316)</i>	<u>14635-1P</u> \$5,810.40	<u>14635-1P</u> \$5,810.40	<u>14637-1P</u> \$5,696.46	<u>14637-1P</u> \$5,696.46	<u>14638-1P</u> \$5,940.73	<u>14640-1P</u> \$5,953.48	<u>14643-1P</u> \$8,407.08

\* Galvanized vertical trim found on page N-6.

**BRASS TRIMS - Conventional Deluge / Preaction Trim**

**Straight Through Valves - VERTICAL**

IPG V237	1-1/2"	2"	2-1/2"	3"	4"	6"	8"
Loose Trim <i>(incl. accessory pkg-09316)</i>	<u>14634-2</u> \$9,045.81	<u>14634-2</u> \$9,045.81	<u>14636-2</u> \$8,591.23	<u>14636-2</u> \$8,591.23	<u>14639-2</u> \$9,179.82	<u>14641-2</u> \$9,285.78	<u>14642-2</u> \$11,570.21
Modular Trim <i>(incl. accessory pkg-09316)</i>	<u>14634-2P</u> \$9,553.33	<u>14634-2P</u> \$9,553.33	<u>14636-2P</u> \$9,098.75	<u>14636-2P</u> \$9,098.75	<u>14639-2P</u> \$9,687.35	<u>14641-2P</u> \$9,793.28	<u>14642-2P</u> \$12,053.58

**Straight Through Valves - HORIZONTAL**

IPG V237	1-1/2"	2"	2-1/2"	3"	4"	6"	8"
Loose Trim <i>(incl. accessory pkg-09316)</i>	<u>14635-2</u> \$9,045.81	<u>14635-2</u> \$9,045.81	<u>14637-2</u> \$8,591.23	<u>14637-2</u> \$8,591.23	<u>14638-2</u> \$9,179.82	<u>14640-2</u> \$9,285.78	<u>14643-2</u> \$11,570.21
Modular Trim <i>(incl. accessory pkg-09316)</i>	<u>14635-2P</u> \$9,553.33	<u>14635-2P</u> \$9,553.33	<u>14637-2P</u> P.O.A.	<u>14637-2P</u> P.O.A.	<u>14638-2P</u> P.O.A.	<u>14640-2P</u> \$9,793.28	<u>14643-2P</u> P.O.A.

**Special Valves and Trim**

**BRASS - Releasing Trims**

V239	Pneumatic	Electric	DOMESTIC <sup>1</sup> Electric
<u>Loose Trim</u> <i>(releasing device not incl.)</i>	<u>10811</u> \$439.39	<u>10832</u> \$494.41	<u>10832USA</u> \$659.20
<u>Modular Trim</u> <i>(releasing device not incl.)</i>	<u>10811P</u> \$987.13	<u>10832P</u> P.O.A.	<u>10832USA-P</u> P.O.A.

**STAINLESS STEEL - Conventional Deluge Trim**

**Straight Through Valves - VERTICAL**

V251	1-1/2"	2"	2-1/2"	3"	4"	6"	8"
<u>Loose Trim</u>	<u>14649</u> \$15,615.53	<u>14649</u> \$15,615.53	<u>14651</u> \$16,742.85	<u>14651</u> \$16,742.85	<u>14654</u> \$18,299.30	<u>14656</u> \$18,374.49	<u>14657</u> \$18,438.73
<u>Modular Trim</u>	<u>14649P</u> \$16,127.80	<u>14649P</u> \$16,127.80	<u>14651P</u> \$17,255.00	<u>14651P</u> \$17,255.00	<u>14654P</u> \$18,811.55	<u>14656P</u> \$18,886.74	<u>14657P</u> P.O.A.

**Straight Through Valves - HORIZONTAL**

V251	1-1/2"	2"	2-1/2"	3"	4"	6"	8"
<u>Loose Trim</u>	<u>14649</u> \$15,615.53	<u>14649</u> \$15,615.53	<u>14651</u> \$16,742.85	<u>14651</u> \$16,742.85	<u>14654</u> \$18,299.30	<u>14656</u> \$18,374.49	<u>14657</u> \$18,438.73
<u>Modular Trim</u>	<u>14649P</u> \$16,127.80	<u>14649P</u> \$16,127.80	<u>14651P</u> \$17,255.00	<u>14651P</u> \$17,255.00	<u>14654P</u> \$18,811.55	<u>14656P</u> \$18,886.74	<u>14657P</u> P.O.A.

**DOMESTIC TRIM<sup>1</sup> - Model F - Galvanized**

**Straight Through Valves - VERTICAL**

V236	1-1/2"	2"	2-1/2"	3"	4"	6"	8"
<u>Loose Trim</u>	<u>14634-1USA</u> \$7,105.65	<u>14634-1USA</u> \$7,105.65	<u>14636-1USA</u> \$6,953.80	<u>14636-1USA</u> \$6,953.80	<u>14639-1USA</u> \$7,276.48	<u>14641-1USA</u> \$7,293.49	<u>14642-1USA</u> \$10,564.96

**Deluge Valve Model VXD**



**VXD Deluge Valves - Pretrimmed Deluge Valves - VERTICAL**

**Pre-trimmed Hydraulic Release Galvanized IPG V402**

1-1/2"	2"	2-1/2"	3"	4"	6"	8"	10"
<u>23543</u>	<u>23575</u>	<u>23596</u>	<u>23617</u>	<u>23638</u>	<u>23660</u>	<u>23681</u>	<u>23702</u>
\$9,451.02	\$9,884.32	\$11,378.02	\$11,574.48	\$12,582.96	\$14,604.90	\$27,892.98	\$34,192.35

**Pre-trimmed Pneumatic Release Galvanized IPG V402**

1-1/2"	2"	2-1/2"	3"	4"	6"	8"	10"
<u>23549</u>	<u>23581</u>	<u>23602</u>	<u>23623</u>	<u>23644</u>	<u>23666</u>	<u>23687</u>	<u>23748</u>
\$10,887.36	\$11,320.65	\$12,591.80	\$12,788.26	\$13,865.47	\$15,818.43	\$29,511.95	\$35,845.12

**Pre-trimmed Electric Release Galvanized IPG V402**

1-1/2"	2"	2-1/2"	3"	4"	6"	8"	10"
<u>23546</u>	<u>23578</u>	<u>23599</u>	<u>23620</u>	<u>23641</u>	<u>23663</u>	<u>23684</u>	<u>23745</u>
\$10,967.15	\$11,400.44	\$12,894.14	\$13,090.60	\$14,099.11	\$16,121.07	\$29,409.15	\$35,708.48

**VXD Deluge Valves - Loose Valve and Trim**

**Model VXD Deluge Valve - Groove/Groove IPG V400**

1-1/2"	2"	2-1/2"	3"	4"	6"	8"	10"
<u>23310</u>	<u>23311</u>	<u>23312</u>	<u>23313</u>	<u>23316</u>	<u>23319</u>	<u>23322</u>	<u>23325</u>
\$3,742.33	\$4,219.80	\$5,853.65	\$6,070.15	\$7,066.71	\$9,286.21	\$21,493.88	\$27,844.71

**Model VXD Deluge Valve - Flange/Flange IPG V400**

3"	4"	6"	8"	10"
<u>23314</u>	<u>23317</u>	<u>23320</u>	<u>23323</u>	<u>23326</u>
\$6,070.15	\$7,066.71	\$9,286.21	\$21,493.88	\$27,844.71

**Loose Trim Hydraulic Release Galvanized IPG V401**

1-1/2"	2"	2-1/2"	3"	4"	6"	8"	10"
<u>23542-1</u>	<u>23574-1</u>	<u>23595-1</u>	<u>23616-1</u>	<u>23637-1</u>	<u>23659-1</u>	<u>23680-1</u>	<u>23701-1</u>
\$4,426.67	\$4,426.67	\$4,436.83	\$4,436.83	\$4,533.03	\$4,540.23	\$6,581.75	\$7,076.97

**Loose Trim Pneumatic Release Galvanized IPG V401**

1-1/2"	2"	2-1/2"	3"	4"	6"	8"	10"
<u>23548-1</u>	<u>23580-1</u>	<u>23601-1</u>	<u>23622-1</u>	<u>23643-1</u>	<u>23665-1</u>	<u>23686-1</u>	<u>23747-1</u>
\$5,753.66	\$5,753.66	\$5,778.35	\$5,778.35	\$5,825.59	\$5,833.05	\$8,077.41	\$8,603.90

**Loose Trim Electric Release Galvanized IPG V401**

1-1/2"	2"	2-1/2"	3"	4"	6"	8"	10"
<u>23545-1</u>	<u>23577-1</u>	<u>23598-1</u>	<u>23619-1</u>	<u>23640-1</u>	<u>23662-1</u>	<u>23683-1</u>	<u>23744-1</u>
\$5,827.37	\$5,827.37	\$5,837.52	\$5,837.52	\$5,933.73	\$5,940.92	\$7,982.44	\$8,477.66

**Deluge Valve Model VXD - Monitored Solenoid Options**

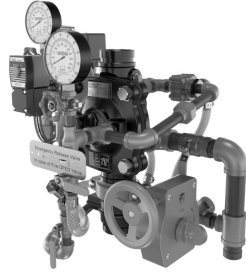

**VXD Deluge Valves - Pretrimmed with Control Valve (PTR) Electric Release, Monitored Solenoid  
 IPG V404**

1-1/2"	2"	2-1/2"	3"	4"	6"	8"
<u>28123</u>	<u>28124</u>	<u>28125</u>	<u>28126</u>	<u>28127</u>	<u>28128</u>	<u>28129</u>
\$13,032.30	\$14,437.17	\$16,577.49	\$16,577.54	\$17,628.79	\$21,227.08	\$35,271.25

**Pre-trimmed Electric Release Galvanized with Monitored Solenoid IPG V402**

1-1/2"	2"	2-1/2"	3"	4"	6"	8"	10"
<u>28064</u>	<u>28068</u>	<u>28053</u>	<u>28070</u>	<u>28046</u>	<u>28072</u>	<u>28097</u>	<u>28099</u>
\$11,965.38	\$12,398.77	\$13,892.38	\$14,088.83	\$15,097.35	\$17,119.28	\$30,407.38	\$36,706.71

**Loose Trim Electric Release Galvanized with Monitored Solenoid IPG V401**

1-1/2"	2"	2-1/2"	3"	4"	6"	8"	10"
<u>28063-1</u>	<u>28067-1</u>	<u>28052-1</u>	<u>28069-1</u>	<u>28044-1</u>	<u>28071-1</u>	<u>28096-1</u>	<u>28098-1</u>
\$6,916.77	\$6,916.77	\$6,916.77	\$6,916.77	\$6,916.77	\$6,940.58	\$8,064.56	\$8,359.24

**Loose Trim Electric Release Brass with Monitored Solenoid IPG V401**

1-1/2"	2"	2-1/2"	3"	4"	6"	8"	10"
<u>28063-2</u>	<u>28067-2</u>	<u>28052-2</u>	<u>28069-2</u>	<u>28044-2</u>	<u>28071-2</u>	<u>28096-2</u>	<u>28098-2</u>
\$8,195.62	\$8,242.60	\$8,472.25	\$8,692.29	\$8,337.47	\$9,860.81	\$12,782.63	\$12,825.63