



Colt™ Series C200, C200N

Double Check Valve Assemblies

Sizes: 2½" – 10" (65 – 250mm)

LEAD FREE*

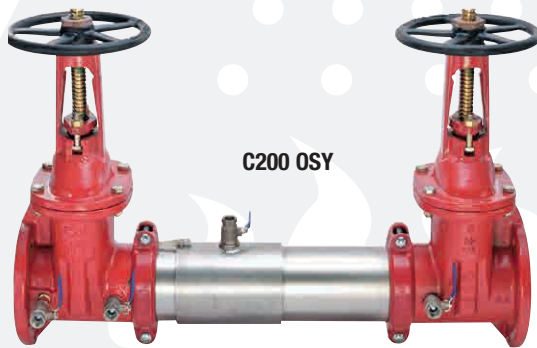

C200 OSY

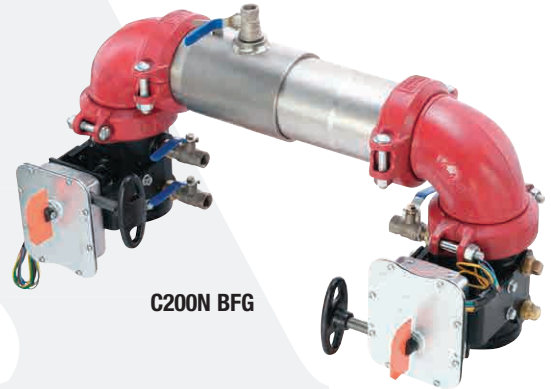

C200N BFG

Features

- Extremely Compact Design
- 70% Lighter than Traditional Designs
- 304 (Schedule 40) Stainless Steel Housing & Sleeve
- Groove Fittings Allow Integral Pipeline Adjustment
- Patented Tri-Link Check Provides Lowest Pressure Loss
- Unmatched Ease of Serviceability
- Available with Grooved Butterfly Valve Shutoffs
- Available for Horizontal, Vertical or N Pattern Installations
- Replaceable Check Disc Rubber

The Colt C200, C200N Double Check Valve Assemblies are used to prevent backflow of pollutants, that are objectionable but not toxic, from entering the potable water supply system. The Colt C200, C200N may be installed under continuous pressure service and may be subjected to backpressure. The Colt C200, C200N consists of two independently operating check valves, two shutoff valves, and four test cocks. For use in non-health hazard applications. The Colt C200, C200N features Lead Free* construction to comply with Lead Free* installation requirements.

Specifications

The Colt C200, C200N Double Check Valve Assembly shall consist of two independent Tri-Link Check modules within a single housing, sleeve access port, four test cocks and two drip tight shutoff valves. Tri-Link Checks shall be removable and serviceable, without the use of special tools. The housing shall be constructed of 304 (Schedule 40) stainless steel pipe with groove end connections. Tri-Link checks shall have reversible elastomer discs and in operation shall produce drip tight closure against the reverse flow of liquid caused by backpressure or backsiphonage. Lead Free* Double Check Valve Assembly shall be constructed using Lead Free* materials. It shall comply with state codes and standards, where applicable, requiring reduced lead content. Assembly shall be a Colt C200, C200N as manufactured by the Ames Company.

NOTICE

The information contained herein is not intended to replace the full product installation and safety information available or the experience of a trained product installer. You are required to thoroughly read all installation instructions and product safety information before beginning the installation of this product.

*The wetted surface of this product contacted by consumable water contains less than 0.25% of lead by weight.

Job Name _____ Contractor _____

Job Location _____ Approval _____

Engineer _____ Contractor's P.O. No. _____

Approval _____ Representative _____

Configurations

- Horizontal
- Vertical up
- “N” pattern horizontal

Materials

- Housing & Sleeve: 304 (Schedule 40) Stainless Steel
- Elastomers: EPDM, Silicone and Buna ‘N’
- Tri-Link Checks: Noryl®, Stainless Steel
- Check Discs: Reversible Silicone or EPDM
- Test Cocks: Bronze Body Nickel Plated
- Pins & Fasteners: 300 Series Stainless Steel
- Springs: Stainless Steel

Available Models

Suffix:

NRS - non-rising stem resilient seated gate valves

OSY - UL/FM outside stem and yoke, resilient seated gate valves

BFG - UL/FM grooved gear operated butterfly valves with tamper switch

*OSY FxG - Flanged inlet gate connection and grooved outlet gate connection

*OSY GxF - Grooved inlet gate connection and flanged outlet gate connection

*OSY GxG - Grooved inlet gate connection and grooved outlet gate connection

Available with grooved NRS gate valves - consult factory*

Post indicator plate and operating nut available - consult factory*

*Consult factory for dimensions

Pressure — Temperature

Temperature Range: 33°F – 140°F (0.5°C – 60°C)

Maximum Working Pressure: 175psi (12.1 bar)

Dimensions — Weights

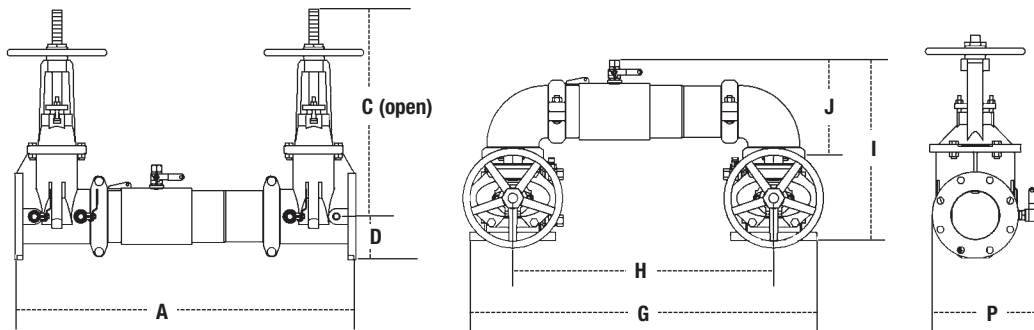

C200, C200N

SIZE (DN)		DIMENSIONS										WEIGHT															
in.	mm	A	C (OSY)	C (NRS)	D	G	H	I	J	P	C200NRS	C200OSY	C200NRS	C200OSY													
		in.	mm	in.	mm	in.	mm	in.	mm	in.	mm	in.	mm	in.	mm	lbs.	kgs.	lbs.	kgs.	lbs.	kgs.						
2½	65	30¾	781	16¾	416	9¾	238	3½	89	29⅞	738	21½	546	15½	393	8⅞	223	9⅞	234	115	52	125	57	123	56	133	60
3	80	31¾	806	18¾	479	10¼	260	3⅞	94	30¼	768	22¼	565	17⅞	435	9⅞	233	10½	267	131	59	145	66	144	65	158	72
4	100	33¾	857	22¾	578	12¾	310	4	102	33	838	23½	597	18½	470	9⅞	252	11¾	284	161	73	161	73	184	83	184	83
6	150	43½	1105	30¾	765	16	406	5½	140	44¾	1137	33¼	845	23¾	589	13⅞	332	15	381	273	124	295	134	314	142	336	152
8	200	49¾	1264	37¾	959	19⅞	506	6⅞	170	54¼	1375	40⅞	1019	27⅞	697	15⅞	399	17¾	437	438	199	480	218	513	233	555	252
10	250	57¾	1467	45¾	1162	23⅞	605	8¾	208	66	1676	49½	1257	32½	826	17¾	440	20	508	721	327	781	354	891	404	951	431

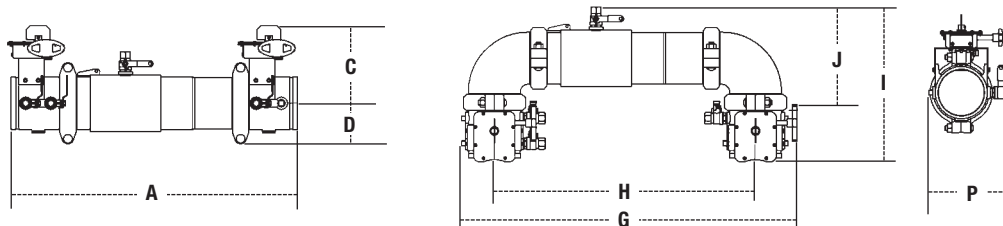

C200BFG, C200NBFG

SIZE (DN)		DIMENSIONS										WEIGHT									
in.	mm	A	C	D	G	H	I	J	P	C200BFG	C200NBFG										
		in.	mm	in.	mm	in.	mm	in.	mm	in.	mm	in.	mm	lbs.	kgs.	lbs.	kgs.				
2½	65	27¾	705	8	203	3½	89	29⅞	759	21½	546	14⅞	379	8⅞	223	9	229	56	25	64	29
3	80	28¾	718	8⅞	211	3⅞	94	30⅞	779	22¼	565	15⅞	392	9⅞	233	9½	241	54	24	67	30
4	100	29	737	8⅞	227	3⅞	94	31⅞	811	23½	597	16¼	412	9⅞	252	10	254	61	28	84	38
6	150	36½	927	10	254	5	127	43⅞	1097	33¼	845	19⅞	500	13⅞	332	10½	267	117	53	157	71
8	200	42¾	1086	12¼	311	6½	165	51⅞	1297	40⅞	1019	23¾	592	15⅞	399	14¾	361	261	118	337	153

Approvals

- Approved by the Foundation for Cross-Connection Control and Hydraulic Research at The University of Southern California (FCCCHR-USC)

For additional approval information please contact the factory or visit our website at www.amesfirewater.com



1015



B64.5



(**BFG & OSY Only)



Approved



Certified to NSF/ANSI 61-G

_____ Horizontal _____ Vertical - - - - - N - Pattern

2 1/2" (65mm)

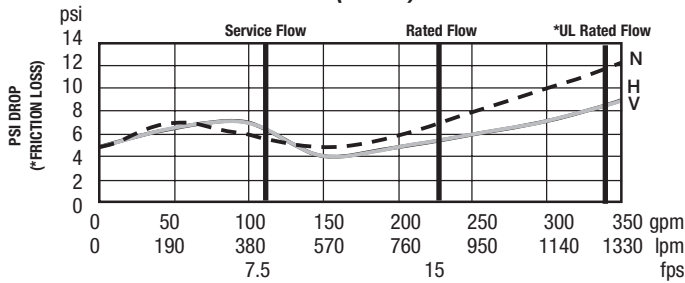

6" (150mm)

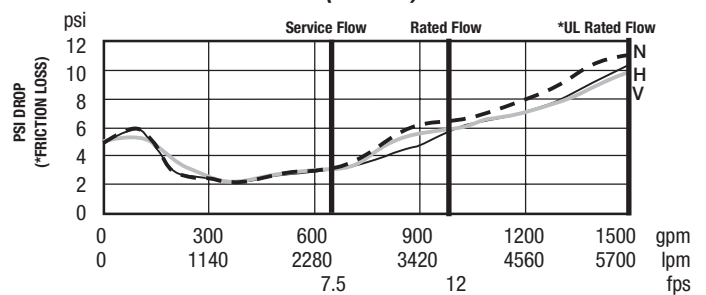

3" (80mm)

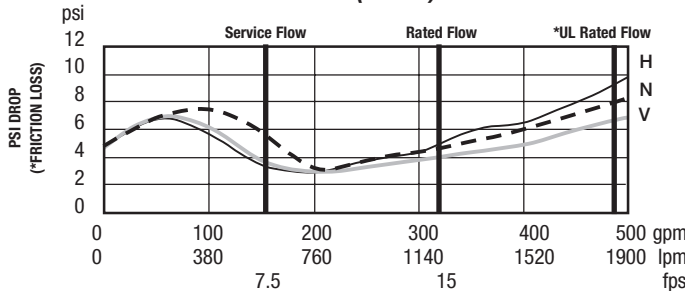

8" (200mm)

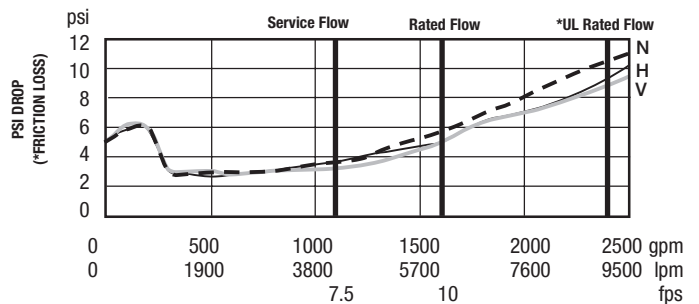

4" (100mm)

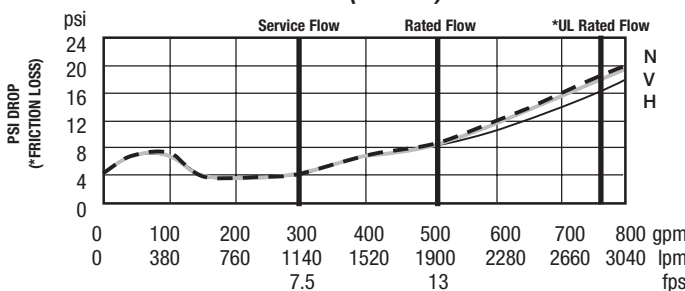

10" (250mm)

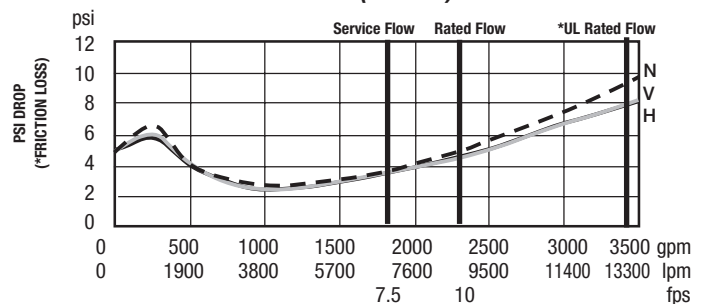

Capacity

UL/FM Certified Flow Characteristics

Flow characteristics collected using butterfly shutoff valves.

Flow capacity chart identifies valve performance based upon rated water velocity up to 25fps

- Service Flow is typically determined by a rated velocity of 7.5fps based upon schedule 40 pipe.
- Rated Flow identifies maximum continuous duty performance determined by AWWA.
- UL Flow Rate is 150% of Rated Flow and is not recommended for continuous duty.
- AWWA Manual M22 [Appendix C] recommends that the maximum water velocity in services be not more than 10fps.

NOTICE

Inquire with governing authorities for local installation requirements



A Watts Water Technologies Company

USA: Backflow Tel: (978) 689-6066 • Fax: (978) 975-8350 • AmesFireWater.com
USA: Control Valves Tel: (713) 943-0688 • Fax: (713) 944-9445 • AmesFireWater.com
Canada: Tel: (905) 332-4090 • Fax: (905) 332-7068 • AmesFireWater.ca
Latin America: Tel: (52) 81-1001-8600 • Fax: (52) 81-8000-7091 • AmesFireWater.com