



Section L
Wet Pipe Systems

TABLE OF CONTENTS

Easy Riser® System L-1
Alarm Check Valve / Trim..... L-2
Special Valves and Trim (Halar® coated valves, brass trim, etc.) L-3
Components and Accessories L-4
Alarm Devices L-5

EasyPac® Riser Assemblies (L.2) – Residential, Commercial, & Floor Control L-6 – L-17

Notes

1. Refer to Viking technical data pages for complete product specifications. You may print or download technical data by visiting www.vikinggroupinc.com.
2. List prices effective May 31, 2021. Supersedes January 2021 list price book.
3. All sales by Viking are subject to the Terms & Conditions found on the last page of this book.

Easy Riser® is a registered trademark of The Viking Corporation
EasyPac® is a registered trademark of The Viking Corporation

Model F-1 Easy Riser® System

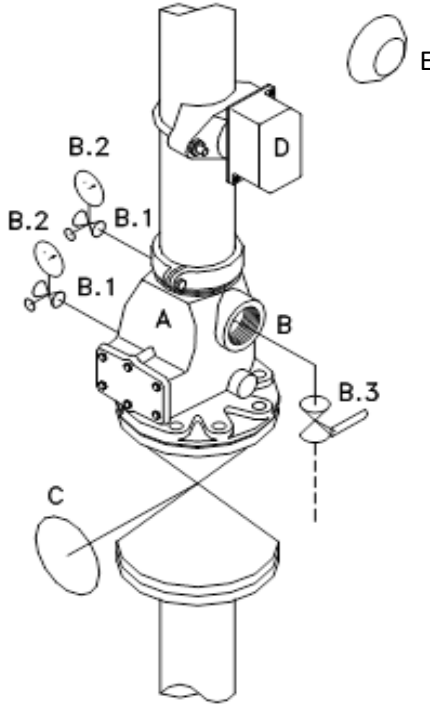



Description	
A	Model F-1 Easy Riser® Swing Check Valve
B	Model F-1 Easy Riser® Trim Including:
B.1	Side Outlet Globe Valve for Gauges
B.2	Water Gauge
B.3	Ball Valve
C	Water Supply Control Valve
D	Waterflow Indicator
E	Electric Alarm Bell

* Trims include indented items immediately following.

UL Listed and FM Approved with 300 PSI (20.7 bar) maximum working pressure

Flange / Flange (Model F-1) - Easy Riser® Swing Check Valve						
Size	Valve (only)		Loose Trim (galvanized)		Valve/Trim (pre-trimmed)	
IPG	V220		V222		V221	
3"	08505	\$1,307.86	07236	\$667.00	08505PT	\$2,434.49
4"	08508	\$1,347.58	07237	\$705.07	08508PT	\$2,512.18
6"	08511	\$2,221.91	07237	\$705.07	08511PT	\$3,400.05
Flange / Groove (Model F-1) - Easy Riser® Swing Check Valve						
Size	Valve (only)		Loose Trim (galvanized)		Valve/Trim (pre-trimmed)	
IPG	V220		V222		V221	
3"	08506	\$1,109.21	07236	\$667.00	08506PT	\$2,232.76
4"	08509	\$1,141.70	07237	\$705.07	08509PT	\$2,303.11
6"	08512	\$1,889.49	07237	\$705.07	08512PT	\$3,062.48
8"	08515	\$2,674.41	07237	\$705.07	08515PT	\$4,764.78
Groove / Groove (Model E-1 / F-1) - Easy Riser® Swing Check Valve						
Size	Valve (only)		Loose Trim (galvanized)		Valve/Trim (pre-trimmed)	
IPG	V220		V222		V221	
2-1/2"	07929	\$942.96	07236	\$667.00	07929PT	\$2,063.94
3"	08507	\$942.96	07236	\$667.00	08507PT	\$2,063.94
4"	08510	\$942.96	07237	\$705.07	08510PT	\$2,101.29
6"	08513	\$1,745.03	07237	\$705.07	08513PT	\$2,915.78
8"	08516	\$2,471.21	07237	\$705.07	08516PT	\$4,489.71

* See page L-3 for special valve and trim options, including domestic, brass, and horizontal trim offerings.

Selected Additional Valves and Components (See pages L-4 and L-5 for complete listing)						
In-Line Check Valves (Threaded) 		Model M-2 Swing Check Valve 		Automatic Ball Drip (Model B-1) 		
<u>Model K-1 (threaded)</u> 1½" 10659 \$787.24 2" 10667 \$910.19 <u>Model L-1 (grooved)</u> 1½" 11054 \$787.24 2" 11059 \$910.19 IPG V259		SPRING LOADED 4" / DN100 IPG V220 22550 \$463.14		½" / DN15 IPG V226 04292B \$66.73		
		In-Line Check Valve Trim (1-1/2 & 2") <u>Model K-1 / L-1</u> IPG V222 1½" and 2" 12960 \$266.25				

Model J-1 Alarm Check Valve

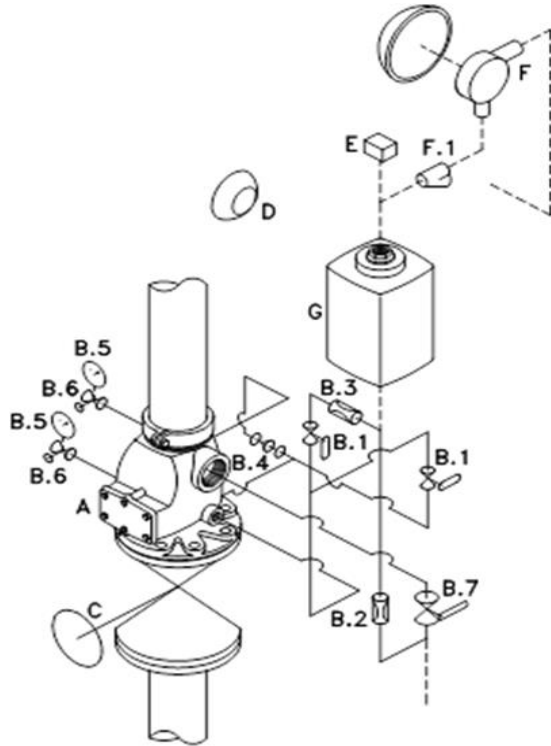

Now cULus Listed and FM Approved with 300 PSI (20.7 bar) maximum working pressure

Description

- A Model J-1 Alarm Check Valve
- B Model J-1 Alarm Valve Trim including:
 - B.1 Alarm Test and Shut-Off Valves
 - B.2 1/8" / 3mm Restricted Orifice
 - B.3 7/32" / 5mm Restricted Orifice
 - B.4 3/4" / DN20 Check Valve
 - B.5 Water Gauge
 - B.6 Side Outlet Globe Valve for Gauges
 - B.7 Ball Valve
- C Water Supply Control Valve
- D Electric Alarm Bell
- E Alarm Pressure Switch
- F Model F-2 Water Motor Alarm including:
 - F.1 3/4" / DN20 Alarm Line Y Strainer
- G Model C-1 Retarding Chamber (NOT INCLUDED IN TRIM)
- H Circuit Closer Vent Trim (Not Shown)

* Trims include indented items immediately following.

Flange / Flange (Model J-1) - Alarm Check Valve					
Size	Valve (only)		Loose Trim (galvanized)		Valve/Trim (pre-trimmed)
IPG	V223		V225		V224
3"	08235	\$2,189.69	08633	\$1,311.00	08235PT \$3,935.79
4"	08238	\$2,189.69	08634	\$1,390.21	08238PT \$4,014.98
6"	08241	\$2,737.13	08635	\$1,390.21	08241PT \$4,562.45
8"	08244	\$3,785.16	08636	\$1,390.21	08244PT \$5,610.49
Flange / Groove (Model J-1) - Alarm Check Valve					
Size	Valve (only)		Loose Trim (galvanized)		Valve/Trim (pre-trimmed)
IPG	V223		V225		V224
3"	08236	\$2,189.69	08633	\$1,311.00	08236PT \$3,935.79
4"	08239	\$2,189.69	08634	\$1,390.21	08239PT \$4,014.98
6"	08242	\$2,737.13	08635	\$1,390.21	08242PT \$4,562.45
8"	08245	\$3,785.16	08636	\$1,390.21	08245PT \$5,610.49
Groove / Groove (Model J-1) - Alarm Check Valve					
Size	Valve (only)		Loose Trim (galvanized)		Valve/Trim (pre-trimmed)
IPG	V223		V225		V224
3"	08237	\$2,067.26	08633	\$1,311.00	08237PT \$3,813.37
4"	08240	\$2,067.26	08634	\$1,390.21	08240PT \$3,892.59
6"	08243	\$2,445.37	08635	\$1,390.21	08243PT \$4,270.71
8"	08246	\$3,374.59	08636	\$1,390.21	08246PT \$5,199.92

* See page L-3 for special valve and trim options, including domestic, brass, and horizontal trim offerings.

Selected Additional Valves and Components (See pages L-4 and L-5 for complete listing)					
<p>Model C-1 Retard Chamber (not in trim)</p> <p>Model C-1 IPG V226 05904B \$865.65</p>	<p>EPP Alarm Valve Trim IPG V227</p> <p>(for use with excess pressure pump)</p>			<p>Circuit Closer Vent Trim IPG V227</p>	
	<p>Water Motor Alarm</p> <p>Model F-2 IPG V226 07862 \$728.68</p>	3" (DN80)	10854	\$1,473.10	<p>01973A \$174.80</p> <p><i>Domestic</i></p> <p>01973AUSA \$233.08</p>
	4" (DN100)	10855	\$1,664.17		
	6" (DN150)	10856	\$1,664.17		
	8" (DN200)	10857	\$1,664.17		

Special Valves and Trim

DOMESTIC¹ TRIM (Vertical/Galvanized) - Model J-1 Alarm Check Valve

Size	Trim (loose)	
IPG	V225	
3"	08633USA	\$1,748.00
4"	08634USA	\$1,854.73
6"	08635USA	\$1,854.73
8"	08636USA	\$1,854.73

(1) Meets sourcing requirements of the Buy American Act, American Reinvestment and Recovery Act, and the Buy American Law. Contact customer service for availability.

BRASS TRIM - Model E-1/F-1 Easy Riser® System

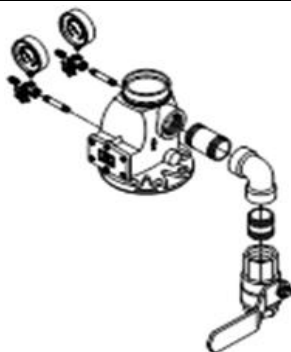

*2-1/2 - 6 inch trim shown

Size	Trim (loose)	
IPG	V222	
Model K-1/L-1 In-line Check Valve		
1-1/2"	12960-1	\$450.17
2"	12960-1	\$450.17
Model E-1/F-1 Easy Riser® Valve		
2-1/2"	07236-1	\$1,127.63
3"	07236-1	\$1,127.63
4"	07237-1	\$1,191.99
6"	07237-1	\$1,191.99
8"	07237-1	\$1,191.99

BRASS TRIM (Vertical) - Model J-1 Alarm Check Valve

Size	Trim (loose)	
IPG	V227	
3"	11428	\$2,315.91
4"	11429	\$2,702.47
6"	11430	\$2,835.90
8"	11431	\$2,835.90

*Retard chamber not included in trim (order separately - see page L-4)

BRASS TRIM (Horizontal) - Model J-1 Alarm Check Valve

Size	Trim (loose)	
IPG	V227	
3"	11432	\$2,398.01
4"	11433	\$2,839.33
6"	11434	\$2,897.51
8"	11435	\$2,897.51

*Retard chamber not included in trim (order separately - see page L-4)

GALVANIZED TRIM (Horizontal) - Model J-1 Alarm Check Valve

Size	Trim (loose)	
IPG	V227	
3"	08763	\$1,424.46
4"	08765	\$1,461.25
6"	08767	\$1,533.60
8"	08769	\$1,533.60

*Retard chamber not included in trim (order separately - see page L-4)

Additional Valves, Trim, and Components

Model D-1 / G-1 Swing Check Valve

Now cULus Listed
and FM Approved
with 300 PSI (20.7
bar) maximum
working pressure



Size	Flange / Flange		Groove / Groove	
IPG	V220		V220	
2-1/2"			05497C	\$661.18
3"			08536	\$661.19
4"	08538	\$1,517.39	08539	\$661.19
6"	08542	\$2,482.05	08543	\$1,578.83
8"	08546	\$2,406.99	08547	\$2,224.10



<p>In-Line Check Valves (Threaded)</p> <p><u>Model K-1 (threaded)</u></p> <table border="0"> <tr> <td>1 1/2"</td> <td>10659</td> <td>\$787.24</td> </tr> <tr> <td>2"</td> <td>10667</td> <td>\$910.19</td> </tr> </table> <p><u>Model L-1 (grooved)</u></p> <table border="0"> <tr> <td>1 1/2"</td> <td>11054</td> <td>\$787.24</td> </tr> <tr> <td>2"</td> <td>11059</td> <td>\$910.19</td> </tr> </table> <p>IPG V259</p>	1 1/2"	10659	\$787.24	2"	10667	\$910.19	1 1/2"	11054	\$787.24	2"	11059	\$910.19	<p>Model M-2 Swing Check Valve</p> <table border="0"> <tr> <td>4" / DN100</td> <td>IPG V220</td> </tr> <tr> <td>22550</td> <td>\$463.14</td> </tr> <tr> <td colspan="2">SPRING LOADED</td> </tr> </table> <p>Circuit Closer Vent Trim IPG V227</p> <p><u>Standard</u></p> <table border="0"> <tr> <td>01973A</td> <td>\$174.80</td> </tr> </table> <p><u>Domestic</u></p> <table border="0"> <tr> <td>01973AUSA</td> <td>\$189.95</td> </tr> </table>	4" / DN100	IPG V220	22550	\$463.14	SPRING LOADED		01973A	\$174.80	01973AUSA	\$189.95	<p>Automatic Ball Drip (Model B-1)</p> <table border="0"> <tr> <td>1/2" / DN15</td> <td>IPG V226</td> </tr> <tr> <td>04292B</td> <td>\$66.73</td> </tr> </table> <p>EPP Alarm Valve Trim IPG V227</p> <p>(for use with excess pressure pump)</p> <table border="0"> <tr> <td>3" (DN80)</td> <td>10854</td> <td>\$1,473.10</td> </tr> <tr> <td>4" (DN100)</td> <td>10855</td> <td>\$1,664.17</td> </tr> <tr> <td>6" (DN150)</td> <td>10856</td> <td>\$1,664.17</td> </tr> <tr> <td>8" (DN200)</td> <td>10857</td> <td>\$1,664.17</td> </tr> </table>	1/2" / DN15	IPG V226	04292B	\$66.73	3" (DN80)	10854	\$1,473.10	4" (DN100)	10855	\$1,664.17	6" (DN150)	10856	\$1,664.17	8" (DN200)	10857	\$1,664.17
1 1/2"	10659	\$787.24																																						
2"	10667	\$910.19																																						
1 1/2"	11054	\$787.24																																						
2"	11059	\$910.19																																						
4" / DN100	IPG V220																																							
22550	\$463.14																																							
SPRING LOADED																																								
01973A	\$174.80																																							
01973AUSA	\$189.95																																							
1/2" / DN15	IPG V226																																							
04292B	\$66.73																																							
3" (DN80)	10854	\$1,473.10																																						
4" (DN100)	10855	\$1,664.17																																						
6" (DN150)	10856	\$1,664.17																																						
8" (DN200)	10857	\$1,664.17																																						
<p>In-Line Check Valve Trim (1-1/2" - 2")</p> <p><u>Model L-1 / K-1</u></p> <table border="0"> <tr> <td>12960</td> <td>\$266.25</td> </tr> </table> <p>IPG V222</p>	12960	\$266.25	<p>Model C-1 Retard Chamber (not in trim)</p> <table border="0"> <tr> <td>Model C-1</td> <td>IPG V226</td> </tr> <tr> <td>05904B</td> <td>\$865.65</td> </tr> </table>	Model C-1	IPG V226	05904B	\$865.65																																	
12960	\$266.25																																							
Model C-1	IPG V226																																							
05904B	\$865.65																																							

Accessories (Included in Alarm Valve Trim) - IPG V226

<p>Water Gauge</p> <p>0-300 psi</p> <table border="0"> <tr> <td>1/4"</td> <td>VWATERSF</td> <td>\$27.45</td> </tr> </table> <p>IPG SR295</p>	1/4"	VWATERSF	\$27.45	<p>Alarm Test/Alarm Shut-Off Valve</p> <p>Main Drain Valve (ball valve)</p> <table border="0"> <tr> <td><u>size</u></td> <td><u>part no.</u></td> <td><u>list price</u></td> </tr> <tr> <td>1/2"</td> <td>10355USA</td> <td>\$38.89</td> </tr> <tr> <td>1"</td> <td>10356</td> <td>\$78.90</td> </tr> </table>	<u>size</u>	<u>part no.</u>	<u>list price</u>	1/2"	10355USA	\$38.89	1"	10356	\$78.90	<p>Restricted Orifice</p> <table border="0"> <tr> <td colspan="3"><u>1/8" / 3mm Restricted Orifice</u></td> </tr> <tr> <td>1/2" / DN15</td> <td>06555A</td> <td>\$37.74</td> </tr> <tr> <td colspan="3"><u>7/32" / 5mm Restricted Orifice</u></td> </tr> <tr> <td>1/2" / DN15</td> <td>06980A</td> <td>\$23.95</td> </tr> <tr> <td colspan="3"><u>3/8" / 9.5mm Restricted Orifice</u></td> </tr> <tr> <td>3/4" / DN20</td> <td>10912</td> <td>\$33.47</td> </tr> <tr> <td colspan="3"><u>7/16" / 11.1mm Restricted Orifice</u></td> </tr> <tr> <td>3/4" CCC</td> <td>12831</td> <td>\$60.54</td> </tr> </table>	<u>1/8" / 3mm Restricted Orifice</u>			1/2" / DN15	06555A	\$37.74	<u>7/32" / 5mm Restricted Orifice</u>			1/2" / DN15	06980A	\$23.95	<u>3/8" / 9.5mm Restricted Orifice</u>			3/4" / DN20	10912	\$33.47	<u>7/16" / 11.1mm Restricted Orifice</u>			3/4" CCC	12831	\$60.54
1/4"	VWATERSF	\$27.45																																				
<u>size</u>	<u>part no.</u>	<u>list price</u>																																				
1/2"	10355USA	\$38.89																																				
1"	10356	\$78.90																																				
<u>1/8" / 3mm Restricted Orifice</u>																																						
1/2" / DN15	06555A	\$37.74																																				
<u>7/32" / 5mm Restricted Orifice</u>																																						
1/2" / DN15	06980A	\$23.95																																				
<u>3/8" / 9.5mm Restricted Orifice</u>																																						
3/4" / DN20	10912	\$33.47																																				
<u>7/16" / 11.1mm Restricted Orifice</u>																																						
3/4" CCC	12831	\$60.54																																				
<p>Globe Valve for Gauges</p> <p><u>Side Outlet</u></p> <table border="0"> <tr> <td>1/4"</td> <td>76V-25</td> <td>\$22.46</td> </tr> </table> <p>IPG SR140</p>	1/4"	76V-25	\$22.46																																			
1/4"	76V-25	\$22.46																																				
<p>In-line Check Valve</p> <table border="0"> <tr> <td>3/4"</td> <td>T480-75</td> <td>\$137.86</td> </tr> <tr> <td>1"</td> <td>T480-0100</td> <td>\$132.04</td> </tr> </table> <p>IPG SR140</p>	3/4"	T480-75	\$137.86	1"	T480-0100	\$132.04																																
3/4"	T480-75	\$137.86																																				
1"	T480-0100	\$132.04																																				

Alarm Devices

Alarm Pressure Switch - SR020

<u>Adjustable Range (4-20 psi)</u> <u>1/2" / DN50</u> Single SPDT PS101A \$235.92 Dual SPDT PS102A \$284.20  * Manufactured by Potter		<u>Explosion Proof</u> Dual SPDT PS10-EX \$1,505.48 Dual SPDT PS40EX \$1,505.48 * Cenelec approved <u>Pressure Adj Access Key</u> 10600 \$32.06 <u>Cover Removal Key</u> 10601 \$32.06 	
--	--	--	--

* Appropriate hex keys included with switches.

Pressure Supervisory Switch (Air, Nitrogen, Water) - IPG SR020



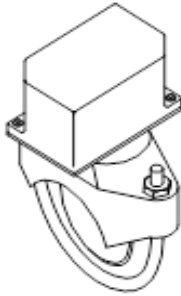

<u>Adjustable Range (10-175 psi)</u> <u>1/2" / DN50</u> Single SPDT PS401A \$235.92 Dual SPDT PS402A \$284.20  * Manufactured by Potter <u>Cover Tamper Switch Kit</u> 09601 \$163.98		<u>Explosion Proof</u> Dual SPDT 10379 \$2,112.54 * Cenelec approved <u>Pressure Adj Access Key</u> 10600 \$32.06 <u>Cover Removal Key</u> 10601 \$32.06 	
--	--	---	--

* Appropriate hex keys included with switches.

Flow Switch - SR010

<u>Waterflow Indicators</u> (adjustable retard up to 120 sec. - 2 SPDT contacts) <u>Model VSR</u> 1-2" / DN40 VSRF0100 \$342.31 2" / DN50 VSRF0200 \$371.02 2½" / DN65 VSRF0250 \$371.02 3" / DN80 VSRF0300 \$371.02 3½" / DN90 VSRF0350 \$371.02 4" / DN100 VSRF0400 \$371.02 5" / DN125 VSRF0500 \$371.02 6" / DN150 VSRF0600 \$371.02 8" / DN200 VSRF0800 \$415.19 		
--	--	--

Water Motor Alarm and Accessories - IPG V226

<u>Water Motor Alarm</u>  Model F-2 07862 \$728.68	<u>Closure Plate</u>  05820B \$148.72
<u>Adjustable Shaft</u> (wall thickness up to 30-1/4 in / 768 mm)  03312B \$142.69	<u>Alarm Line Y Strainer</u>  ¾" (DN20) 01489A \$216.98
<u>Extension Cup</u>  05957B \$118.98	

EasyPac™ Residential Riser Assemblies		
Basic (w/ ball valve)	TESTanDRAIN®	TESTanDRAIN® & PRV
Features and Benefits of all EasyPac™ Riser Assemblies <ul style="list-style-type: none"> - Assembled in the United States. - Made with UL listed and FM approved components. - Field replaceable parts for ease of service. - Fabricated steel riser body with black E-coat finish. - Compact, lightweight design for easy installation. - Built-in test port allows hydrostatic testing w/out draining system. - Pressure rating: 250 PSI max water working pressure. - Includes Potter® VSR flow switch. 		

RESIDENTIAL - Basic (with ball valve)			
Size	Part #	IPG	List Price
Groove x Groove (schedule 10)			
1"	15243	V263	\$1,051.26
1-1/4"	14841	V263	\$1,007.49
1-1/2"	14843	V263	\$1,075.69
2"	14845	V263	\$1,095.68
Thread x Groove (schedule 40)			
1-1/4"	14905	V263	\$1,032.03
1-1/2"	14849	V263	\$1,084.37
2"	14846	V263	\$1,103.29
Thread x Thread (schedule 40)			
1"	15226	V263	\$1,008.55
1-1/4"	14840	V263	\$1,008.95
1-1/2"	14842	V263	\$1,078.38
2"	14844	V263	\$1,099.45

RESIDENTIAL (with TESTanDRAIN®)					RESIDENTIAL (with TESTanDRAIN®)				
Size	Orifice Size	Part #	IPG	List Price	Size	Orifice Size	Part #	IPG	List Price
Groove x Groove (schedule 10)					Thread x Groove (schedule 40)				
1"	3/8" (2.8 K)	15244A	V263	\$1,666.17	1-1/4"	3/8" (2.8 K)	15233A	V263	\$1,723.85
1"	7/16" (4.2 K)	15244B	V263	\$1,666.17	1-1/4"	7/16" (4.2 K)	15233B	V263	\$1,723.85
1"	1/2" (5.6 K)	15244C	V263	\$1,666.17	1-1/4"	1/2" (5.6 K)	15233C	V263	\$1,723.85
1"	17/32" (8.0 K)	15244D	V263	\$1,666.17	1-1/4"	17/32" (8.0 K)	15233D	V263	\$1,723.85
1-1/4"	3/8" (2.8 K)	15231A	V263	\$1,698.79	1-1/2"	3/8" (2.8 K)	15239A	V263	\$1,709.89
1-1/4"	7/16" (4.2 K)	15231B	V263	\$1,698.79	1-1/2"	7/16" (4.2 K)	15239B	V263	\$1,709.89
1-1/4"	1/2" (5.6 K)	15231C	V263	\$1,698.79	1-1/2"	1/2" (5.6 K)	15239C	V263	\$1,709.89
1-1/4"	17/32" (8.0 K)	15231D	V263	\$1,698.79	1-1/2"	17/32" (8.0 K)	15239D	V263	\$1,709.89
1-1/2"	3/8" (2.8 K)	15237A	V263	\$1,701.22	2"	3/8" (2.8 K)	15246A	V263	\$1,557.94
1-1/2"	7/16" (4.2 K)	15237B	V263	\$1,701.22	2"	7/16" (4.2 K)	15246B	V263	\$1,557.94
1-1/2"	1/2" (5.6 K)	15237C	V263	\$1,701.22	2"	1/2" (5.6 K)	15246C	V263	\$1,557.94
1-1/2"	17/32" (8.0 K)	15237D	V263	\$1,701.22	2"	17/32" (8.0 K)	15246D	V263	\$1,557.94
2"	3/8" (2.8 K)	15242A	V263	\$1,547.77					
2"	7/16" (4.2 K)	15242B	V263	\$1,547.77					
2"	1/2" (5.6 K)	15242C	V263	\$1,547.77					
2"	17/32" (8.0 K)	15242D	V263	\$1,547.77					
Thread x Thread (schedule 40)									
1"	3/8" (2.8 K)	15227A	V263	\$1,623.93					
1"	7/16" (4.2 K)	15227B	V263	\$1,623.93					
1"	1/2" (5.6 K)	15227C	V263	\$1,623.93					
1"	17/32" (8.0 K)	15227D	V263	\$1,623.93					
1-1/4"	3/8" (2.8 K)	15229A	V263	\$1,700.24					
1-1/4"	7/16" (4.2 K)	15229B	V263	\$1,700.24					
1-1/4"	1/2" (5.6 K)	15229C	V263	\$1,700.24					
1-1/4"	17/32" (8.0 K)	15229D	V263	\$1,700.24					
1-1/2"	3/8" (2.8 K)	15235A	V263	\$1,703.92					
1-1/2"	7/16" (4.2 K)	15235B	V263	\$1,703.92					
1-1/2"	1/2" (5.6 K)	15235C	V263	\$1,703.92					
1-1/2"	17/32" (8.0 K)	15235D	V263	\$1,703.92					
2"	3/8" (2.8 K)	15241A	V263	\$1,551.51					
2"	7/16" (4.2 K)	15241B	V263	\$1,551.51					
2"	1/2" (5.6 K)	15241C	V263	\$1,551.51					
2"	17/32" (8.0 K)	15241D	V263	\$1,551.51					

TESTanDRAIN® is a registered trademark of AGF Manufacturing, Inc.



RESIDENTIAL (with TESTanDRAIN® and PRV)											
Size	Orifice Size	PRV ¹	Part #	IPG	List Price	Size	Orifice Size	PRV ¹	Part #	IPG	List Price
Groove x Groove (schedule 10)						Thread x Groove (schedule 10)					
1"	3/8" (2.8 K)	175	15245A175	V263	\$1,855.17	N/A					
1"	3/8" (2.8 K)	205	15245A205	V263	\$1,855.17						
1"	3/8" (2.8 K)	250	15245A250	V263	\$1,855.17						
1"	7/16" (4.2 K)	175	15245B175	V263	\$1,855.17						
1"	7/16" (4.2 K)	205	15245B205	V263	\$1,855.17						
1"	7/16" (4.2 K)	250	15245B250	V263	\$1,855.17						
1"	1/2" (5.6 K)	175	15245C175	V263	\$1,855.17						
1"	1/2" (5.6 K)	205	15245C205	V263	\$1,855.17						
1"	1/2" (5.6 K)	250	15245C250	V263	\$1,855.17						
1"	17/32" (8.0 K)	175	15245D175	V263	\$1,855.17						
1"	17/32" (8.0 K)	205	15245D205	V263	\$1,855.17						
1"	17/32" (8.0 K)	250	15245D250	V263	\$1,855.17						
1-1/4"	3/8" (2.8 K)	175	15232A175	V263	\$1,887.32						
1-1/4"	3/8" (2.8 K)	205	15232A205	V263	\$1,887.32						
1-1/4"	3/8" (2.8 K)	250	15232A250	V263	\$1,887.32						
1-1/4"	7/16" (4.2 K)	175	15232B175	V263	\$1,887.32						
1-1/4"	7/16" (4.2 K)	205	15232B205	V263	\$1,887.32						
1-1/4"	7/16" (4.2 K)	250	15232B250	V263	\$1,887.32						
1-1/4"	1/2" (5.6 K)	175	15232C175	V263	\$1,887.32						
1-1/4"	1/2" (5.6 K)	205	15232C205	V263	\$1,887.32						
1-1/4"	1/2" (5.6 K)	250	15232C250	V263	\$1,887.32						
1-1/4"	17/32" (8.0 K)	175	15232D175	V263	\$1,887.32						
1-1/4"	17/32" (8.0 K)	205	15232D205	V263	\$1,887.32						
1-1/4"	17/32" (8.0 K)	250	15232D250	V263	\$1,887.32						
1-1/2"	3/8" (2.8 K)	175	15238A175	V263	\$1,889.75	1-1/4"	3/8" (2.8 K)	175	15234A175	V263	\$1,912.36
1-1/2"	3/8" (2.8 K)	205	15238A205	V263	\$1,889.75	1-1/4"	3/8" (2.8 K)	205	15234A205	V263	\$1,912.36
1-1/2"	3/8" (2.8 K)	250	15238A250	V263	\$1,889.75	1-1/4"	3/8" (2.8 K)	250	15234A250	V263	\$1,912.36
1-1/2"	7/16" (4.2 K)	175	15238B175	V263	\$1,889.75	1-1/4"	7/16" (4.2 K)	175	15234B175	V263	\$1,912.36
1-1/2"	7/16" (4.2 K)	205	15238B205	V263	\$1,889.75	1-1/4"	7/16" (4.2 K)	205	15234B205	V263	\$1,912.36
1-1/2"	7/16" (4.2 K)	250	15238B250	V263	\$1,889.75	1-1/4"	7/16" (4.2 K)	250	15234B250	V263	\$1,912.36
1-1/2"	1/2" (5.6 K)	175	15238C175	V263	\$1,889.75	1-1/4"	1/2" (5.6 K)	175	15234C175	V263	\$1,912.36
1-1/2"	1/2" (5.6 K)	205	15238C205	V263	\$1,889.75	1-1/4"	1/2" (5.6 K)	205	15234C205	V263	\$1,912.36
1-1/2"	1/2" (5.6 K)	250	15238C250	V263	\$1,889.75	1-1/4"	1/2" (5.6 K)	250	15234C250	V263	\$1,912.36
1-1/2"	17/32" (8.0 K)	175	15238D175	V263	\$1,889.75	1-1/4"	17/32" (8.0 K)	175	15234D175	V263	\$1,912.36
1-1/2"	17/32" (8.0 K)	205	15238D205	V263	\$1,889.75	1-1/4"	17/32" (8.0 K)	205	15234D205	V263	\$1,912.36
1-1/2"	17/32" (8.0 K)	250	15238D250	V263	\$1,889.75	1-1/4"	17/32" (8.0 K)	250	15234D250	V263	\$1,912.36
2"	3/8" (2.8 K)	175	14900A175	V263	\$1,931.33	1-1/2"	3/8" (2.8 K)	175	15240A175	V263	\$1,898.41
2"	3/8" (2.8 K)	205	14900A205	V263	\$1,931.33	1-1/2"	3/8" (2.8 K)	205	15240A205	V263	\$1,898.41
2"	3/8" (2.8 K)	250	14900A250	V263	\$1,931.33	1-1/2"	3/8" (2.8 K)	250	15240A250	V263	\$1,898.41
2"	7/16" (4.2 K)	175	14900B175	V263	\$1,931.33	1-1/2"	7/16" (4.2 K)	175	15240B175	V263	\$1,898.41
2"	7/16" (4.2 K)	205	14900B205	V263	\$1,931.33	1-1/2"	7/16" (4.2 K)	205	15240B205	V263	\$1,898.41
2"	7/16" (4.2 K)	250	14900B250	V263	\$1,931.33	1-1/2"	7/16" (4.2 K)	250	15240B250	V263	\$1,898.41
2"	1/2" (5.6 K)	175	14900C175	V263	\$1,931.33	1-1/2"	1/2" (5.6 K)	175	15240C175	V263	\$1,898.41
2"	1/2" (5.6 K)	205	14900C205	V263	\$1,931.33	1-1/2"	1/2" (5.6 K)	205	15240C205	V263	\$1,898.41
2"	1/2" (5.6 K)	250	14900C250	V263	\$1,931.33	1-1/2"	1/2" (5.6 K)	250	15240C250	V263	\$1,898.41
2"	17/32" (8.0 K)	175	14900D175	V263	\$1,931.33	1-1/2"	17/32" (8.0 K)	175	15240D175	V263	\$1,898.41
2"	17/32" (8.0 K)	205	14900D205	V263	\$1,931.33	1-1/2"	17/32" (8.0 K)	205	15240D205	V263	\$1,898.41
2"	17/32" (8.0 K)	250	14900D250	V263	\$1,931.33	1-1/2"	17/32" (8.0 K)	250	15240D250	V263	\$1,898.41
2"	3/8" (2.8 K)	175	15247A175	V263	\$1,749.36	2"	3/8" (2.8 K)	175	15247A175	V263	\$1,749.36
2"	3/8" (2.8 K)	205	15247A205	V263	\$1,749.36	2"	3/8" (2.8 K)	205	15247A205	V263	\$1,749.36
2"	3/8" (2.8 K)	250	15247A250	V263	\$1,749.36	2"	3/8" (2.8 K)	250	15247A250	V263	\$1,749.36
2"	7/16" (4.2 K)	175	15247B175	V263	\$1,749.36	2"	7/16" (4.2 K)	175	15247B175	V263	\$1,749.36
2"	7/16" (4.2 K)	205	15247B205	V263	\$1,749.36	2"	7/16" (4.2 K)	205	15247B205	V263	\$1,749.36
2"	7/16" (4.2 K)	250	15247B250	V263	\$1,749.36	2"	7/16" (4.2 K)	250	15247B250	V263	\$1,749.36
2"	1/2" (5.6 K)	175	15247C175	V263	\$1,749.36	2"	1/2" (5.6 K)	175	15247C175	V263	\$1,749.36
2"	1/2" (5.6 K)	205	15247C205	V263	\$1,749.36	2"	1/2" (5.6 K)	205	15247C205	V263	\$1,749.36
2"	1/2" (5.6 K)	250	15247C250	V263	\$1,749.36	2"	1/2" (5.6 K)	250	15247C250	V263	\$1,749.36
2"	17/32" (8.0 K)	175	15247D175	V263	\$1,749.36	2"	17/32" (8.0 K)	175	15247D175	V263	\$1,749.36
2"	17/32" (8.0 K)	205	15247D205	V263	\$1,749.36	2"	17/32" (8.0 K)	205	15247D205	V263	\$1,749.36
2"	17/32" (8.0 K)	250	15247D250	V263	\$1,749.36	2"	17/32" (8.0 K)	250	15247D250	V263	\$1,749.36

(1) Refers to factory pressure setting (psi) of pressure relief valve (PRV). See technical data page # 31 a-e for details.

TESTanDRAIN® is a registered trademark of AGF Manufacturing, Inc.

Residential (with TESTanDRAIN® and PRV)					
Size	Orifice Size	PRV ¹	Part #	IPG	List Price
Thread x Thread (schedule 40)					
1"	3/8" (2.8 K)	175	15228A175	V263	\$1,812.45
1"	3/8" (2.8 K)	205	15228A205	V263	\$1,812.45
1"	3/8" (2.8 K)	250	15228A250	V263	\$1,812.45
1"	7/16" (4.2 K)	175	15228B175	V263	\$1,812.45
1"	7/16" (4.2 K)	205	15228B205	V263	\$1,812.45
1"	7/16" (4.2 K)	250	15228B250	V263	\$1,812.45
1"	1/2" (5.6 K)	175	15228C175	V263	\$1,812.45
1"	1/2" (5.6 K)	205	15228C205	V263	\$1,812.45
1"	1/2" (5.6 K)	250	15228C250	V263	\$1,812.45
1"	17/32" (8.0 K)	175	15228D175	V263	\$1,812.45
1"	17/32" (8.0 K)	205	15228D205	V263	\$1,812.45
1"	17/32" (8.0 K)	250	15228D250	V263	\$1,812.45
1-1/4"	3/8" (2.8 K)	175	15230A175	V263	\$1,888.76
1-1/4"	3/8" (2.8 K)	205	15230A205	V263	\$1,888.76
1-1/4"	3/8" (2.8 K)	250	15230A250	V263	\$1,888.76
1-1/4"	7/16" (4.2 K)	175	15230B175	V263	\$1,888.76
1-1/4"	7/16" (4.2 K)	205	15230B205	V263	\$1,888.76
1-1/4"	7/16" (4.2 K)	250	15230B250	V263	\$1,888.76
1-1/4"	1/2" (5.6 K)	175	15230C175	V263	\$1,888.76
1-1/4"	1/2" (5.6 K)	205	15230C205	V263	\$1,888.76
1-1/4"	1/2" (5.6 K)	250	15230C250	V263	\$1,888.76
1-1/4"	17/32" (8.0 K)	175	15230D175	V263	\$1,888.76
1-1/4"	17/32" (8.0 K)	205	15230D205	V263	\$1,888.76
1-1/4"	17/32" (8.0 K)	250	15230D250	V263	\$1,888.76
1-1/2"	3/8" (2.8 K)	175	15236A175	V263	\$1,892.43
1-1/2"	3/8" (2.8 K)	205	15236A205	V263	\$1,892.43
1-1/2"	3/8" (2.8 K)	250	15236A250	V263	\$1,892.43
1-1/2"	7/16" (4.2 K)	175	15236B175	V263	\$1,892.43
1-1/2"	7/16" (4.2 K)	205	15236B205	V263	\$1,892.43
1-1/2"	7/16" (4.2 K)	250	15236B250	V263	\$1,892.43
1-1/2"	1/2" (5.6 K)	175	15236C175	V263	\$1,892.43
1-1/2"	1/2" (5.6 K)	205	15236C205	V263	\$1,892.43
1-1/2"	1/2" (5.6 K)	250	15236C250	V263	\$1,892.43
1-1/2"	17/32" (8.0 K)	175	15236D175	V263	\$1,892.43
1-1/2"	17/32" (8.0 K)	205	15236D205	V263	\$1,892.43
1-1/2"	17/32" (8.0 K)	250	15236D250	V263	\$1,892.43
2"	3/8" (2.8 K)	175	14901A175	V263	\$1,944.26
2"	3/8" (2.8 K)	205	14901A205	V263	\$1,944.26
2"	3/8" (2.8 K)	250	14901A250	V263	\$1,944.26
2"	7/16" (4.2 K)	175	14901B175	V263	\$1,944.26
2"	7/16" (4.2 K)	205	14901B205	V263	\$1,944.26
2"	7/16" (4.2 K)	250	14901B250	V263	\$1,944.26
2"	1/2" (5.6 K)	175	14901C175	V263	\$1,944.26
2"	1/2" (5.6 K)	205	14901C205	V263	\$1,944.26
2"	1/2" (5.6 K)	250	14901C250	V263	\$1,944.26
2"	17/32" (8.0 K)	175	14901D175	V263	\$1,944.26
2"	17/32" (8.0 K)	205	14901D205	V263	\$1,944.26
2"	17/32" (8.0 K)	250	14901D250	V263	\$1,944.26

(1) Refers to factory pressure setting (psi) of pressure relief valve (PRV). See technical data page # 31 a-e for details.

TESTanDRAIN® is a registered trademark of AGF Manufacturing, Inc.

EasyPac™ COMMERCIAL Riser Assemblies		
Basic (w/ ball valve)	TESTanDRAIN®	TESTanDRAIN® & PRV
Features and Benefits of all EasyPac™ Riser Assemblies <ul style="list-style-type: none"> - Assembled in the United States. - Made with UL listed and FM approved components. - Field replaceable parts for ease of service. - Fabricated steel riser body with black E-coat finish. - Compact, lightweight design for easy installation. - Built-in test port allows hydrostatic testing w/out draining system. - Pressure rating: 250 PSI max water working pressure. - Includes Potter® VSR flow switch. 		

COMMERCIAL -Basic (with ball valve)			
Size	Part #	IPG	List Price
Groove x Groove (schedule 10)			
1-1/4"	15249	V261	\$1,544.54
1-1/2"	15254	V261	\$1,141.71
2"	14848	V261	\$1,020.13
2-1/2"	14852	V261	\$1,049.47
3"	14855	V261	\$1,177.72
4"	14858	V261	\$1,375.52
6"	14861	V261	\$1,537.97
8"	15264	V261	\$2,167.98
Thread x Groove (schedule 40)			
1-1/4"	15250	V261	\$1,575.81
1-1/2"	15255	V261	\$1,150.88
2"	15258	V261	\$1,233.39
Thread x Thread (schedule 40)			
1-1/4"	15248	V261	\$1,546.36
1-1/2"	15253	V261	\$1,144.55
2"	14899	V261	\$1,052.55

COMMERCIAL (with TESTanDRAIN®)					COMMERCIAL (with TESTanDRAIN®)				
Size	Orifice Size	Part #	IPG	List Price	Size	Orifice Size	Part #	IPG	List Price
Groove x Groove (schedule 10)					Groove x Groove (schedule 10)				
1-1/4"	3/8" (2.8 K)	14872A	V261	\$1,803.00	3"	3/8" (2.8 K)	14856A	V261	\$1,935.00
1-1/4"	7/16" (4.2 K)	14872B	V261	\$1,803.00	3"	7/16" (4.2 K)	14856B	V261	\$1,935.00
1-1/4"	1/2" (5.6 K)	14872C	V261	\$1,803.00	3"	1/2" (5.6 K)	14856C	V261	\$1,935.00
1-1/4"	17/32" (8.0 K)	14872D	V261	\$1,803.00	3"	17/32" (8.0 K)	14856D	V261	\$1,935.00
1-1/4"	ELO (11.2 K)	14872E	V261	\$1,803.00	3"	ELO (11.2 K)	14856E	V261	\$1,935.00
					3"	ESFR (14.0 K)	14856F	V261	\$1,935.00
					3"	ESFR (25.2 K)	14856G	V261	P.O.A.
1-1/2"	3/8" (2.8 K)	14876A	V261	\$1,805.59	4"	3/8" (2.8 K)	14859A	V261	\$2,547.36
1-1/2"	7/16" (4.2 K)	14876B	V261	\$1,805.59	4"	7/16" (4.2 K)	14859B	V261	\$2,547.36
1-1/2"	1/2" (5.6 K)	14876C	V261	\$1,805.59	4"	1/2" (5.6 K)	14859C	V261	\$2,547.36
1-1/2"	17/32" (8.0 K)	14876D	V261	\$1,805.59	4"	17/32" (8.0 K)	14859D	V261	\$2,547.36
1-1/2"	ELO (11.2 K)	14876E	V261	\$1,805.59	4"	ELO (11.2 K)	14859E	V261	\$2,547.36
					4"	ESFR (14.0 K)	14859F	V261	\$2,547.36
					4"	ESFR (25.2 K)	14859G	V261	\$2,649.94
2"	3/8" (2.8 K)	14850A	V261	\$1,773.80	6"	3/8" (2.8 K)	14862A	V261	\$2,756.01
2"	7/16" (4.2 K)	14850B	V261	\$1,773.80	6"	7/16" (4.2 K)	14862B	V261	\$2,756.01
2"	1/2" (5.6 K)	14850C	V261	\$1,773.80	6"	1/2" (5.6 K)	14862C	V261	\$2,756.01
2"	17/32" (8.0 K)	14850D	V261	\$1,773.80	6"	17/32" (8.0 K)	14862D	V261	\$2,756.01
2"	ELO (11.2 K)	14850E	V261	\$1,773.80	6"	ELO (11.2 K)	14862E	V261	\$2,756.01
					6"	ESFR (14.0 K)	14862F	V261	\$2,756.01
					6"	ESFR (25.2 K)	14862G	V261	\$2,787.02
2-1/2"	3/8" (2.8 K)	14853A	V261	\$1,806.73	8"	3/8" (2.8 K)	15265A	V261	\$3,729.68
2-1/2"	7/16" (4.2 K)	14853B	V261	\$1,806.73	8"	7/16" (4.2 K)	15265B	V261	\$3,729.68
2-1/2"	1/2" (5.6 K)	14853C	V261	\$1,806.73	8"	1/2" (5.6 K)	15265C	V261	\$3,729.68
2-1/2"	17/32" (8.0 K)	14853D	V261	\$1,806.73	8"	17/32" (8.0 K)	15265D	V261	\$3,729.68
2-1/2"	ELO (11.2 K)	14853E	V261	\$1,806.73	8"	ELO (11.2 K)	15265E	V261	\$3,729.68
2-1/2"	ESFR (14.0 K)	14853F	V261	\$1,806.73	8"	ESFR (14.0 K)	15265F	V261	\$3,729.68
2-1/2"	ESFR (25.2 K)	14853G	V261	P.O.A.	8"	ESFR (25.2 K)	15265G	V261	\$3,729.68

TESTanDRAIN® is a registered trademark of AGF Manufacturing, Inc.



COMMERCIAL (with TESTanDRAIN®)									
Size	Orifice Size	Part #	IPG	List Price	Size	Orifice Size	Part #	IPG	List Price
Thread x Groove (schedule 40)					Thread x Thread (schedule 40)				
1-1/4"	3/8" (2.8 K)	15251A	V261	\$1,829.63	1-1/4"	3/8" (2.8 K)	14871A	V261	\$1,804.58
1-1/4"	7/16" (4.2 K)	15251B	V261	\$1,829.63	1-1/4"	7/16" (4.2 K)	14871B	V261	\$1,804.58
1-1/4"	1/2" (5.6 K)	15251C	V261	\$1,829.63	1-1/4"	1/2" (5.6 K)	14871C	V261	\$1,804.58
1-1/4"	17/32" (8.0 K)	15251D	V261	\$1,829.63	1-1/4"	17/32" (8.0 K)	14871D	V261	\$1,804.58
1-1/4"	17/32" (8.0 K)	15251E	V261	\$1,829.63	1-1/4"	17/32" (8.0 K)	14871E	V261	\$1,804.58
1-1/2"	3/8" (2.8 K)	15256A	V261	\$1,814.77	1-1/2"	3/8" (2.8 K)	14875A	V261	\$1,808.47
1-1/2"	7/16" (4.2 K)	15256B	V261	\$1,814.77	1-1/2"	7/16" (4.2 K)	14875B	V261	\$1,808.47
1-1/2"	1/2" (5.6 K)	15256C	V261	\$1,814.77	1-1/2"	1/2" (5.6 K)	14875C	V261	\$1,808.47
1-1/2"	17/32" (8.0 K)	15256D	V261	\$1,814.77	1-1/2"	17/32" (8.0 K)	14875D	V261	\$1,808.47
1-1/2"	17/32" (8.0 K)	15256E	V261	\$1,814.77	1-1/2"	17/32" (8.0 K)	14875E	V261	\$1,808.47
2"	3/8" (2.8 K)	15259A	V261	\$2,119.62	2"	3/8" (2.8 K)	14935A	V261	\$1,806.73
2"	7/16" (4.2 K)	15259B	V261	\$2,119.62	2"	7/16" (4.2 K)	14935B	V261	\$1,806.73
2"	1/2" (5.6 K)	15259C	V261	\$2,119.62	2"	1/2" (5.6 K)	14935C	V261	\$1,806.73
2"	17/32" (8.0 K)	15259D	V261	\$2,119.62	2"	17/32" (8.0 K)	14935D	V261	\$1,806.73
2"	ELO (11.2 K)	15259E	V261	\$2,119.62	2"	ELO (11.2 K)	14935E	V261	\$1,806.73

COMMERCIAL (with TESTanDRAIN® and PRV)											
Size	Orifice Size	PRV ¹	Part #	IPG	List Price	Size	Orifice Size	PRV ¹	Part #	IPG	List Price
Groove x Groove (schedule 10)						Groove x Groove (schedule 10)					
1-1/4"	3/8" (2.8 K)	175	14874A175	V261	\$2,003.12	2"	3/8" (2.8 K)	175	14851A175	V261	\$1,977.48
1-1/4"	3/8" (2.8 K)	205	14874A205	V261	\$2,003.12	2"	3/8" (2.8 K)	205	14851A205	V261	\$1,977.48
1-1/4"	3/8" (2.8 K)	250	14874A250	V261	\$2,003.12	2"	3/8" (2.8 K)	250	14851A250	V261	\$1,977.48
1-1/4"	7/16" (4.2 K)	175	14874B175	V261	\$2,003.12	2"	7/16" (4.2 K)	175	14851B175	V261	\$1,977.48
1-1/4"	7/16" (4.2 K)	205	14874B205	V261	\$2,003.12	2"	7/16" (4.2 K)	205	14851B205	V261	\$1,977.48
1-1/4"	7/16" (4.2 K)	250	14874B250	V261	\$2,003.12	2"	7/16" (4.2 K)	250	14851B250	V261	\$1,977.48
1-1/4"	1/2" (5.6 K)	175	14874C175	V261	\$2,003.12	2"	1/2" (5.6 K)	175	14851C175	V261	\$1,977.48
1-1/4"	1/2" (5.6 K)	205	14874C205	V261	\$2,003.12	2"	1/2" (5.6 K)	205	14851C205	V261	\$1,977.48
1-1/4"	1/2" (5.6 K)	250	14874C250	V261	\$2,003.12	2"	1/2" (5.6 K)	250	14851C250	V261	\$1,977.48
1-1/4"	17/32" (8.0 K)	175	14874D175	V261	\$2,003.12	2"	17/32" (8.0 K)	175	14851D175	V261	\$1,977.48
1-1/4"	17/32" (8.0 K)	205	14874D205	V261	\$2,003.12	2"	17/32" (8.0 K)	205	14851D205	V261	\$1,977.48
1-1/4"	17/32" (8.0 K)	250	14874D250	V261	\$2,003.12	2"	17/32" (8.0 K)	250	14851D250	V261	\$1,977.48
1-1/4"	ELO (11.2 K)	175	14874E175	V261	\$2,003.12	2"	ELO (11.2 K)	175	14851E175	V261	\$1,977.48
1-1/4"	ELO (11.2 K)	205	14874E205	V261	\$2,003.12	2"	ELO (11.2 K)	205	14851E205	V261	\$1,977.48
1-1/4"	ELO (11.2 K)	250	14874E250	V261	\$2,003.12	2"	ELO (11.2 K)	250	14851E250	V261	\$1,977.48
1-1/2"	3/8" (2.8 K)	175	14878A175	V261	\$2,005.71	2-1/2"	3/8" (2.8 K)	175	14854A175	V261	\$2,010.45
1-1/2"	3/8" (2.8 K)	205	14878A205	V261	\$2,005.71	2-1/2"	3/8" (2.8 K)	205	14854A205	V261	\$2,010.45
1-1/2"	3/8" (2.8 K)	250	14878A250	V261	\$2,005.71	2-1/2"	3/8" (2.8 K)	250	14854A250	V261	\$2,010.45
1-1/2"	7/16" (4.2 K)	175	14878B175	V261	\$2,005.71	2-1/2"	7/16" (4.2 K)	175	14854B175	V261	\$2,010.45
1-1/2"	7/16" (4.2 K)	205	14878B205	V261	\$2,005.71	2-1/2"	7/16" (4.2 K)	205	14854B205	V261	\$2,010.45
1-1/2"	7/16" (4.2 K)	250	14878B250	V261	\$2,005.71	2-1/2"	7/16" (4.2 K)	250	14854B250	V261	\$2,010.45
1-1/2"	1/2" (5.6 K)	175	14878C175	V261	\$2,005.71	2-1/2"	1/2" (5.6 K)	175	14854C175	V261	\$2,010.45
1-1/2"	1/2" (5.6 K)	205	14878C205	V261	\$2,005.71	2-1/2"	1/2" (5.6 K)	205	14854C205	V261	\$2,010.45
1-1/2"	1/2" (5.6 K)	250	14878C250	V261	\$2,005.71	2-1/2"	1/2" (5.6 K)	250	14854C250	V261	\$2,010.45
1-1/2"	17/32" (8.0 K)	175	14878D175	V261	\$2,005.71	2-1/2"	17/32" (8.0 K)	175	14854D175	V261	\$2,010.45
1-1/2"	17/32" (8.0 K)	205	14878D205	V261	\$2,005.71	2-1/2"	17/32" (8.0 K)	205	14854D205	V261	\$2,010.45
1-1/2"	17/32" (8.0 K)	250	14878D250	V261	\$2,005.71	2-1/2"	17/32" (8.0 K)	250	14854D250	V261	\$2,010.45
1-1/2"	ELO (11.2 K)	175	14878E175	V261	\$2,005.71	2-1/2"	ELO (11.2 K)	175	14854E175	V261	\$2,010.45
1-1/2"	ELO (11.2 K)	205	14878E205	V261	\$2,005.71	2-1/2"	ELO (11.2 K)	205	14854E205	V261	\$2,010.45
1-1/2"	ELO (11.2 K)	250	14878E250	V261	\$2,005.71	2-1/2"	ELO (11.2 K)	250	14854E250	V261	\$2,010.45
						2-1/2"	ESFR (14.0 K)	175	14854F175	V261	\$2,010.45
						2-1/2"	ESFR (14.0 K)	205	14854F205	V261	\$2,010.45
						2-1/2"	ESFR (14.0 K)	250	14854F250	V261	\$2,010.45

(1) Refers to factory pressure setting (psi) of pressure relief valve (PRV). See technical data page # 31 a-e for details.



COMMERCIAL (with TESTanDRAIN® and PRV)											
Size	Orifice Size	PRV ¹	Part #	IPG	List Price	Size	Orifice Size	PRV ¹	Part #	IPG	List Price
Groove x Groove (schedule 10)						Groove x Groove (schedule 10)					
3"	3/8" (2.8 K)	175	14857A175	V261	\$2,138.67	6"	3/8" (2.8 K)	175	14863A175	V261	\$2,956.09
3"	3/8" (2.8 K)	205	14857A205	V261	\$2,138.67	6"	3/8" (2.8 K)	205	14863A205	V261	\$2,956.09
3"	3/8" (2.8 K)	250	14857A250	V261	\$2,138.67	6"	3/8" (2.8 K)	250	14863A250	V261	\$2,956.09
3"	7/16" (4.2 K)	175	14857B175	V261	\$2,138.67	6"	7/16" (4.2 K)	175	14863B175	V261	\$2,956.09
3"	7/16" (4.2 K)	205	14857B205	V261	\$2,138.67	6"	7/16" (4.2 K)	205	14863B205	V261	\$2,956.09
3"	7/16" (4.2 K)	250	14857B250	V261	\$2,138.67	6"	7/16" (4.2 K)	250	14863B250	V261	\$2,956.09
3"	1/2" (5.6 K)	175	14857C175	V261	\$2,138.67	6"	1/2" (5.6 K)	175	14863C175	V261	\$2,956.09
3"	1/2" (5.6 K)	205	14857C205	V261	\$2,138.67	6"	1/2" (5.6 K)	205	14863C205	V261	\$2,956.09
3"	1/2" (5.6 K)	250	14857C250	V261	\$2,138.67	6"	1/2" (5.6 K)	250	14863C250	V261	\$2,956.09
3"	17/32" (8.0 K)	175	14857D175	V261	\$2,138.67	6"	17/32" (8.0 K)	175	14863D175	V261	\$2,956.09
3"	17/32" (8.0 K)	205	14857D205	V261	\$2,138.67	6"	17/32" (8.0 K)	205	14863D205	V261	\$2,956.09
3"	17/32" (8.0 K)	250	14857D250	V261	\$2,138.67	6"	17/32" (8.0 K)	250	14863D250	V261	\$2,956.09
3"	ELO (11.2 K)	175	14857E175	V261	\$2,138.67	6"	ELO (11.2 K)	175	14863E175	V261	\$2,956.09
3"	ELO (11.2 K)	205	14857E205	V261	\$2,138.67	6"	ELO (11.2 K)	205	14863E205	V261	\$2,956.09
3"	ELO (11.2 K)	250	14857E250	V261	\$2,138.67	6"	ELO (11.2 K)	250	14863E250	V261	\$2,956.09
3"	ESFR - 14.0 K	175	14857F175	V261	\$2,138.67	6"	ESFR - 14.0 K	175	14863F175	V261	\$2,956.09
3"	ESFR - 14.0 K	205	14857F205	V261	\$2,138.67	6"	ESFR - 14.0 K	205	14863F205	V261	\$2,956.09
3"	ESFR - 14.0 K	250	14857F250	V261	\$2,138.67	6"	ESFR - 14.0 K	250	14863F250	V261	\$2,956.09
3"	ESFR - 25.2 K	175	14857G175	V261	P.O.A.	6"	ESFR - 25.2 K	175	14863G175	V261	\$2,987.02
3"	ESFR - 25.2 K	205	14857G205	V261	P.O.A.	6"	ESFR - 25.2 K	205	14863G205	V261	\$2,987.02
3"	ESFR - 25.2 K	250	14857G250	V261	P.O.A.	6"	ESFR - 25.2 K	250	14863G250	V261	\$2,987.02
4"	3/8" (2.8 K)	175	14860A175	V261	\$2,747.48	8"	3/8" (2.8 K)	175	15266A175	V261	\$3,996.33
4"	3/8" (2.8 K)	205	14860A205	V261	\$2,747.48	8"	3/8" (2.8 K)	205	15266A205	V261	\$3,996.33
4"	3/8" (2.8 K)	250	14860A250	V261	\$2,747.48	8"	3/8" (2.8 K)	250	15266A250	V261	\$3,996.33
4"	7/16" (4.2 K)	175	14860B175	V261	\$2,747.48	8"	7/16" (4.2 K)	175	15266B175	V261	\$3,996.33
4"	7/16" (4.2 K)	205	14860B205	V261	\$2,747.48	8"	7/16" (4.2 K)	205	15266B205	V261	\$3,996.33
4"	7/16" (4.2 K)	250	14860B250	V261	\$2,747.48	8"	7/16" (4.2 K)	250	15266B250	V261	\$3,996.33
4"	1/2" (5.6 K)	175	14860C175	V261	\$2,747.48	8"	1/2" (5.6 K)	175	15266C175	V261	\$3,996.33
4"	1/2" (5.6 K)	205	14860C205	V261	\$2,747.48	8"	1/2" (5.6 K)	205	15266C205	V261	\$3,996.33
4"	1/2" (5.6 K)	250	14860C250	V261	\$2,747.48	8"	1/2" (5.6 K)	250	15266C250	V261	\$3,996.33
4"	17/32" (8.0 K)	175	14860D175	V261	\$2,747.48	8"	17/32" (8.0 K)	175	15266D175	V261	\$3,996.33
4"	17/32" (8.0 K)	205	14860D205	V261	\$2,747.48	8"	17/32" (8.0 K)	205	15266D205	V261	\$3,996.33
4"	17/32" (8.0 K)	250	14860D250	V261	\$2,747.48	8"	17/32" (8.0 K)	250	15266D250	V261	\$3,996.33
4"	ELO (11.2 K)	175	14860E175	V261	\$2,747.48	8"	ELO (11.2 K)	175	15266E175	V261	\$3,996.33
4"	ELO (11.2 K)	205	14860E205	V261	\$2,747.48	8"	ELO (11.2 K)	205	15266E205	V261	\$3,996.33
4"	ELO (11.2 K)	250	14860E250	V261	\$2,747.48	8"	ELO (11.2 K)	250	15266E250	V261	\$3,996.33
4"	ESFR (14.0 K)	175	14860F175	V261	\$2,747.48	8"	ESFR (14.0 K)	175	15266F175	V261	\$3,996.33
4"	ESFR (14.0 K)	205	14860F205	V261	\$2,747.48	8"	ESFR (14.0 K)	205	15266F205	V261	\$3,996.33
4"	ESFR (14.0 K)	250	14860F250	V261	\$2,747.48	8"	ESFR (14.0 K)	250	15266F250	V261	\$3,996.33
4"	ESFR (25.2 K)	175	14860G175	V261	\$2,849.94	8"	ESFR (25.2 K)	175	15266G175	V261	\$3,996.33
4"	ESFR (25.2 K)	205	14860G205	V261	\$2,849.94	8"	ESFR (25.2 K)	205	15266G205	V261	\$3,996.33
4"	ESFR (25.2 K)	250	14860G250	V261	\$2,849.94	8"	ESFR (25.2 K)	250	15266G250	V261	\$3,996.33

(1) Refers to factory pressure setting (psi) of pressure relief valve (PRV). See technical data page # 31 a-e for details.

TESTanDRAIN® is a registered trademark of AGF Manufacturing, Inc.



COMMERCIAL (with TESTanDRAIN® and PRV)											
Size	Orifice Size	PRV ¹	Part #	IPG	List Price	Size	Orifice Size	PRV ¹	Part #	IPG	List Price
Thread x Groove (schedule 40)						Thread x Thread (schedule 40)					
1-1/4"	3/8" (2.8 K)	175	15252A175	V261	\$2,029.69	1-1/4"	3/8" (2.8 K)	175	14873A175	V261	\$2,004.67
1-1/4"	3/8" (2.8 K)	205	15252A205	V261	\$2,029.69	1-1/4"	3/8" (2.8 K)	205	14873A205	V261	\$2,004.67
1-1/4"	3/8" (2.8 K)	250	15252A250	V261	\$2,029.69	1-1/4"	3/8" (2.8 K)	250	14873A250	V261	\$2,004.67
1-1/4"	7/16" (4.2 K)	175	15252B175	V261	\$2,029.69	1-1/4"	7/16" (4.2 K)	175	14873B175	V261	\$2,004.67
1-1/4"	7/16" (4.2 K)	205	15252B205	V261	\$2,029.69	1-1/4"	7/16" (4.2 K)	205	14873B205	V261	\$2,004.67
1-1/4"	7/16" (4.2 K)	250	15252B250	V261	\$2,029.69	1-1/4"	7/16" (4.2 K)	250	14873B250	V261	\$2,004.67
1-1/4"	1/2" (5.6 K)	175	15252C175	V261	\$2,029.69	1-1/4"	1/2" (5.6 K)	175	14873C175	V261	\$2,004.67
1-1/4"	1/2" (5.6 K)	205	15252C205	V261	\$2,029.69	1-1/4"	1/2" (5.6 K)	205	14873C205	V261	\$2,004.67
1-1/4"	1/2" (5.6 K)	250	15252C250	V261	\$2,029.69	1-1/4"	1/2" (5.6 K)	250	14873C250	V261	\$2,004.67
1-1/4"	17/32" (8.0 K)	175	15252D175	V261	\$2,029.69	1-1/4"	17/32" (8.0 K)	175	14873D175	V261	\$2,004.67
1-1/4"	17/32" (8.0 K)	205	15252D205	V261	\$2,029.69	1-1/4"	17/32" (8.0 K)	205	14873D205	V261	\$2,004.67
1-1/4"	17/32" (8.0 K)	250	15252D250	V261	\$2,029.69	1-1/4"	17/32" (8.0 K)	250	14873D250	V261	\$2,004.67
1-1/4"	ELO (11.2 K)	175	15252E175	V261	\$2,029.69	1-1/4"	ELO (11.2 K)	175	14873E175	V261	\$2,004.67
1-1/4"	ELO (11.2 K)	205	15252E205	V261	\$2,029.69	1-1/4"	ELO (11.2 K)	205	14873E205	V261	\$2,004.67
1-1/4"	ELO (11.2 K)	250	15252E250	V261	\$2,029.69	1-1/4"	ELO (11.2 K)	250	14873E250	V261	\$2,004.67
1-1/2"	3/8" (2.8 K)	175	15257A175	V261	\$2,014.87	1-1/2"	3/8" (2.8 K)	175	14877A175	V261	\$2,008.52
1-1/2"	3/8" (2.8 K)	205	15257A205	V261	\$2,014.87	1-1/2"	3/8" (2.8 K)	205	14877A205	V261	\$2,008.52
1-1/2"	3/8" (2.8 K)	250	15257A250	V261	\$2,014.87	1-1/2"	3/8" (2.8 K)	250	14877A250	V261	\$2,008.52
1-1/2"	7/16" (4.2 K)	175	15257B175	V261	\$2,014.87	1-1/2"	7/16" (4.2 K)	175	14877B175	V261	\$2,008.52
1-1/2"	7/16" (4.2 K)	205	15257B205	V261	\$2,014.87	1-1/2"	7/16" (4.2 K)	205	14877B205	V261	\$2,008.52
1-1/2"	7/16" (4.2 K)	250	15257B250	V261	\$2,014.87	1-1/2"	7/16" (4.2 K)	250	14877B250	V261	\$2,008.52
1-1/2"	1/2" (5.6 K)	175	15257C175	V261	\$2,014.87	1-1/2"	1/2" (5.6 K)	175	14877C175	V261	\$2,008.52
1-1/2"	1/2" (5.6 K)	205	15257C205	V261	\$2,014.87	1-1/2"	1/2" (5.6 K)	205	14877C205	V261	\$2,008.52
1-1/2"	1/2" (5.6 K)	250	15257C250	V261	\$2,014.87	1-1/2"	1/2" (5.6 K)	250	14877C250	V261	\$2,008.52
1-1/2"	17/32" (8.0 K)	175	15257D175	V261	\$2,014.87	1-1/2"	17/32" (8.0 K)	175	14877D175	V261	\$2,008.52
1-1/2"	17/32" (8.0 K)	205	15257D205	V261	\$2,014.87	1-1/2"	17/32" (8.0 K)	205	14877D205	V261	\$2,008.52
1-1/2"	17/32" (8.0 K)	250	15257D250	V261	\$2,014.87	1-1/2"	17/32" (8.0 K)	250	14877D250	V261	\$2,008.52
1-1/2"	ELO (11.2 K)	175	15257E175	V261	\$2,014.87	1-1/2"	ELO (11.2 K)	175	14877E175	V261	\$2,008.52
1-1/2"	ELO (11.2 K)	205	15257E205	V261	\$2,014.87	1-1/2"	ELO (11.2 K)	205	14877E205	V261	\$2,008.52
1-1/2"	ELO (11.2 K)	250	15257E250	V261	\$2,014.87	1-1/2"	ELO (11.2 K)	250	14877E250	V261	\$2,008.52
2"	3/8" (2.8 K)	175	15260A175	V261	\$2,359.11	2"	3/8" (2.8 K)	175	14847A175	V261	\$2,010.45
2"	3/8" (2.8 K)	205	15260A205	V261	\$2,359.11	2"	3/8" (2.8 K)	205	14847A205	V261	\$2,010.45
2"	3/8" (2.8 K)	250	15260A250	V261	\$2,359.11	2"	3/8" (2.8 K)	250	14847A250	V261	\$2,010.45
2"	7/16" (4.2 K)	175	15260B175	V261	\$2,359.11	2"	7/16" (4.2 K)	175	14847B175	V261	\$2,010.45
2"	7/16" (4.2 K)	205	15260B205	V261	\$2,359.11	2"	7/16" (4.2 K)	205	14847B205	V261	\$2,010.45
2"	7/16" (4.2 K)	250	15260B250	V261	\$2,359.11	2"	7/16" (4.2 K)	250	14847B250	V261	\$2,010.45
2"	1/2" (5.6 K)	175	15260C175	V261	\$2,359.11	2"	1/2" (5.6 K)	175	14847C175	V261	\$2,010.45
2"	1/2" (5.6 K)	205	15260C205	V261	\$2,359.11	2"	1/2" (5.6 K)	205	14847C205	V261	\$2,010.45
2"	1/2" (5.6 K)	250	15260C250	V261	\$2,359.11	2"	1/2" (5.6 K)	250	14847C250	V261	\$2,010.45
2"	17/32" (8.0 K)	175	15260D175	V261	\$2,359.11	2"	17/32" (8.0 K)	175	14847D175	V261	\$2,010.45
2"	17/32" (8.0 K)	205	15260D205	V261	\$2,359.11	2"	17/32" (8.0 K)	205	14847D205	V261	\$2,010.45
2"	17/32" (8.0 K)	250	15260D250	V261	\$2,359.11	2"	17/32" (8.0 K)	250	14847D250	V261	\$2,010.45
2"	ELO (11.2 K)	175	15260E175	V261	\$2,359.11	2"	ELO (11.2 K)	175	14874E175	V261	\$2,003.12
2"	ELO (11.2 K)	205	15260E205	V261	\$2,359.11	2"	ELO (11.2 K)	205	14874E205	V261	\$2,003.12
2"	ELO (11.2 K)	250	15260E250	V261	\$2,359.11	2"	ELO (11.2 K)	250	14874E250	V261	\$2,003.12

(1) Refers to factory pressure setting (psi) of pressure relief valve (PRV). See technical data page # 31 a-e for details.

TESTanDRAIN® is a registered trademark of AGF Manufacturing, Inc.

EasyPac™ FLOOR CONTROL Riser Assemblies		
Basic (w/ ball valve)	TESTanDRAIN®	TESTanDRAIN® & PRV
Features and Benefits of all EasyPac™ Riser Assemblies <ul style="list-style-type: none"> - Assembled in the United States. - Made with UL listed and FM approved components. - Field replaceable parts for ease of service. - Fabricated steel riser body with black E-coat finish. - Compact, lightweight design for easy installation. - Built-in test port allows hydrostatic testing w/out draining system. - Pressure rating: 250 PSI max water working pressure. - Includes Potter® VSR flow switch. 		

Floor Control - Basic (with ball valve)			
Size	Part #	IPG	List Price
Groove x Groove (schedule 10)			
1-1/4"	15270	V262	\$1,172.63
1-1/2"	15279	V262	\$1,252.06
2"	15288	V262	\$1,123.43
2-1/2"	15297	V262	\$1,135.26
3"	15300	V262	\$1,295.20
4"	15303	V262	\$1,509.90
6"	15294	V262	\$1,609.65
8"	15261	V262	\$1,895.56
Thread x Groove (schedule 40)			
1-1/4"	15273	V262	\$1,201.81
1-1/2"	15282	V262	\$1,262.14
2"	15291	V262	\$1,150.28
Thread x Thread (schedule 40)			
1-1/4"	15267	V262	\$1,174.35
1-1/2"	15276	V262	\$1,254.61
2"	15285	V262	\$1,159.90

FLOOR CONTROL (with TESTanDRAIN®)									
Size	Orifice Size	Part #	IPG	List Price	Size	Orifice Size	Part #	IPG	List Price
Groove x Groove (schedule 10)					Groove x Groove (schedule 10)				
1-1/4"	3/8" (2.8 K)	15271A	V262	\$1,977.31	3"	3/8" (2.8 K)	15301A	V262	\$2,049.13
1-1/4"	7/16" (4.2 K)	15271B	V262	\$1,977.31	3"	7/16" (4.2 K)	15301B	V262	\$2,049.13
1-1/4"	1/2" (5.6 K)	15271C	V262	\$1,977.31	3"	1/2" (5.6 K)	15301C	V262	\$2,049.13
1-1/4"	17/32" (8.0 K)	15271D	V262	\$1,977.31	3"	17/32" (8.0 K)	15301D	V262	\$2,049.13
1-1/4"	ELO (11.2 K)	15271E	V262	\$1,977.31	3"	ELO (11.2 K)	15301E	V262	\$2,049.13
					3"	ESFR (14.0 K)	15301F	V262	\$2,049.13
1-1/2"	3/8" (2.8 K)	15280A	V262	\$1,980.13	3"	ESFR (25.2 K)	15301G	V262	P.O.A.
1-1/2"	7/16" (4.2 K)	15280B	V262	\$1,980.13	4"	3/8" (2.8 K)	15304A	V262	\$2,795.02
1-1/2"	1/2" (5.6 K)	15280C	V262	\$1,980.13	4"	7/16" (4.2 K)	15304B	V262	\$2,795.02
1-1/2"	17/32" (8.0 K)	15280D	V262	\$1,980.13	4"	1/2" (5.6 K)	15304C	V262	\$2,795.02
1-1/2"	ELO (11.2 K)	15280E	V262	\$1,980.13	4"	17/32" (8.0 K)	15304D	V262	\$2,795.02
					4"	ELO (11.2 K)	15304E	V262	\$2,795.02
2"	3/8" (2.8 K)	15289A	V262	\$1,949.95	4"	ESFR (14.0 K)	15304F	V262	\$2,795.02
2"	7/16" (4.2 K)	15289B	V262	\$1,949.95	4"	ESFR (25.2 K)	15304G	V262	P.O.A.
2"	1/2" (5.6 K)	15289C	V262	\$1,949.95	6"	3/8" (2.8 K)	15295A	V262	\$2,945.43
2"	17/32" (8.0 K)	15289D	V262	\$1,949.95	6"	7/16" (4.2 K)	15295B	V262	\$2,945.43
2"	ELO (11.2 K)	15289E	V262	\$1,949.95	6"	1/2" (5.6 K)	15295C	V262	\$2,945.43
					6"	17/32" (8.0 K)	15295D	V262	\$2,945.43
2-1/2"	3/8" (2.8 K)	15298A	V262	\$1,965.41	6"	ELO (11.2 K)	15295E	V262	\$2,945.43
2-1/2"	7/16" (4.2 K)	15298B	V262	\$1,965.41	6"	ESFR (14.0 K)	15295F	V262	\$2,945.43
2-1/2"	1/2" (5.6 K)	15298C	V262	\$1,965.41	6"	ESFR (25.2 K)	15295G	V262	P.O.A.
2-1/2"	17/32" (8.0 K)	15298D	V262	\$1,965.41	8"	3/8" (2.8 K)	15262A	V262	\$3,261.00
2-1/2"	ELO (11.2 K)	15298E	V262	\$1,965.41	8"	7/16" (4.2 K)	15262B	V262	\$3,261.00
2-1/2"	ESFR (14.0 K)	15298F	V262	\$1,965.41	8"	1/2" (5.6 K)	15262C	V262	\$3,261.00
2-1/2"	ESFR (25.2 K)	15298G	V262	P.O.A.	8"	17/32" (8.0 K)	15262D	V262	\$3,261.00
					8"	ELO (11.2 K)	15262E	V262	\$3,261.00
					8"	ESFR (14.0 K)	15262F	V262	\$3,261.00
					8"	ESFR (25.2 K)	15262G	V262	\$3,380.60

TESTanDRAIN® is a registered trademark of AGF Manufacturing, Inc.



FLOOR CONTROL (with TESTanDRAIN®)									
Size	Orifice Size	Part #	IPG	List Price	Size	Orifice Size	Part #	IPG	List Price
Thread x Groove (schedule 40)					Thread x Thread (schedule 40)				
1-1/4"	3/8" (2.8 K)	15274A	V262	\$2,006.48	1-1/4"	3/8" (2.8 K)	15268A	V262	\$1,979.01
1-1/4"	7/16" (4.2 K)	15274B	V262	\$2,006.48	1-1/4"	7/16" (4.2 K)	15268B	V262	\$1,979.01
1-1/4"	1/2" (5.6 K)	15274C	V262	\$2,006.48	1-1/4"	1/2" (5.6 K)	15268C	V262	\$1,979.01
1-1/4"	17/32" (8.0 K)	15274D	V262	\$2,006.48	1-1/4"	17/32" (8.0 K)	15268D	V262	\$1,979.01
1-1/4"	17/32" (8.0 K)	15274E	V262	\$2,006.48	1-1/4"	17/32" (8.0 K)	15268E	V262	\$1,979.01
1-1/2"	3/8" (2.8 K)	15283A	V262	\$1,990.22	1-1/2"	3/8" (2.8 K)	15277A	V262	\$1,983.28
1-1/2"	7/16" (4.2 K)	15283B	V262	\$1,990.22	1-1/2"	7/16" (4.2 K)	15277B	V262	\$1,983.28
1-1/2"	1/2" (5.6 K)	15283C	V262	\$1,990.22	1-1/2"	1/2" (5.6 K)	15277C	V262	\$1,983.28
1-1/2"	17/32" (8.0 K)	15283D	V262	\$1,990.22	1-1/2"	17/32" (8.0 K)	15277D	V262	\$1,983.28
1-1/2"	17/32" (8.0 K)	15283E	V262	\$1,990.22	1-1/2"	17/32" (8.0 K)	15277E	V262	\$1,983.28
2"	3/8" (2.8 K)	15292A	V262	\$1,976.85	2"	3/8" (2.8 K)	15286A	V262	\$1,986.45
2"	7/16" (4.2 K)	15292B	V262	\$1,976.85	2"	7/16" (4.2 K)	15286B	V262	\$1,986.45
2"	1/2" (5.6 K)	15292C	V262	\$1,976.85	2"	1/2" (5.6 K)	15286C	V262	\$1,986.45
2"	17/32" (8.0 K)	15292D	V262	\$1,976.85	2"	17/32" (8.0 K)	15286D	V262	\$1,986.45
2"	ELO (11.2 K)	15292E	V262	\$1,976.85	2"	ELO (11.2 K)	15286E	V262	\$1,986.45

FLOOR CONTROL (with TESTanDRAIN® and PRV)											
Size	Orifice Size	PRV ¹	Part #	IPG	List Price	Size	Orifice Size	PRV ¹	Part #	IPG	List Price
Groove x Groove (schedule 10)						Groove x Groove (schedule 10)					
1-1/4"	3/8" (2.8 K)	175	15272A175	V262	\$2,196.73	2"	3/8" (2.8 K)	175	15290A175	V262	\$2,173.31
1-1/4"	3/8" (2.8 K)	205	15272A205	V262	\$2,196.73	2"	3/8" (2.8 K)	205	15290A205	V262	\$2,173.31
1-1/4"	3/8" (2.8 K)	250	15272A250	V262	\$2,196.73	2"	3/8" (2.8 K)	250	15290A250	V262	\$2,173.31
1-1/4"	7/16" (4.2 K)	175	15272B175	V262	\$2,196.73	2"	7/16" (4.2 K)	175	15290B175	V262	\$2,173.31
1-1/4"	7/16" (4.2 K)	205	15272B205	V262	\$2,196.73	2"	7/16" (4.2 K)	205	15290B205	V262	\$2,173.31
1-1/4"	7/16" (4.2 K)	250	15272B250	V262	\$2,196.73	2"	7/16" (4.2 K)	250	15290B250	V262	\$2,173.31
1-1/4"	1/2" (5.6 K)	175	15272C175	V262	\$2,196.73	2"	1/2" (5.6 K)	175	15290C175	V262	\$2,173.31
1-1/4"	1/2" (5.6 K)	205	15272C205	V262	\$2,196.73	2"	1/2" (5.6 K)	205	15290C205	V262	\$2,173.31
1-1/4"	1/2" (5.6 K)	250	15272C250	V262	\$2,196.73	2"	1/2" (5.6 K)	250	15290C250	V262	\$2,173.31
1-1/4"	17/32" (8.0 K)	175	15272D175	V262	\$2,196.73	2"	17/32" (8.0 K)	175	15290D175	V262	\$2,173.31
1-1/4"	17/32" (8.0 K)	205	15272D205	V262	\$2,196.73	2"	17/32" (8.0 K)	205	15290D205	V262	\$2,173.31
1-1/4"	17/32" (8.0 K)	250	15272D250	V262	\$2,196.73	2"	17/32" (8.0 K)	250	15290D250	V262	\$2,173.31
1-1/4"	ELO (11.2 K)	175	15272E175	V262	\$2,196.73	2"	ELO (11.2 K)	175	15290E175	V262	\$2,173.31
1-1/4"	ELO (11.2 K)	205	15272E205	V262	\$2,196.73	2"	ELO (11.2 K)	205	15290E205	V262	\$2,173.31
1-1/4"	ELO (11.2 K)	250	15272E250	V262	\$2,196.73	2"	ELO (11.2 K)	250	15290E250	V262	\$2,173.31
1-1/2"	3/8" (2.8 K)	175	15281A175	V262	\$2,199.59	2-1/2"	3/8" (2.8 K)	175	15299A175	V262	\$2,189.12
1-1/2"	3/8" (2.8 K)	205	15281A205	V262	\$2,199.59	2-1/2"	3/8" (2.8 K)	205	15299A205	V262	\$2,189.12
1-1/2"	3/8" (2.8 K)	250	15281A250	V262	\$2,199.59	2-1/2"	3/8" (2.8 K)	250	15299A250	V262	\$2,189.12
1-1/2"	7/16" (4.2 K)	175	15281B175	V262	\$2,199.59	2-1/2"	7/16" (4.2 K)	175	15299B175	V262	\$2,189.12
1-1/2"	7/16" (4.2 K)	205	15281B205	V262	\$2,199.59	2-1/2"	7/16" (4.2 K)	205	15299B205	V262	\$2,189.12
1-1/2"	7/16" (4.2 K)	250	15281B250	V262	\$2,199.59	2-1/2"	7/16" (4.2 K)	250	15299B250	V262	\$2,189.12
1-1/2"	1/2" (5.6 K)	175	15281C175	V262	\$2,199.59	2-1/2"	1/2" (5.6 K)	175	15299C175	V262	\$2,189.12
1-1/2"	1/2" (5.6 K)	205	15281C205	V262	\$2,199.59	2-1/2"	1/2" (5.6 K)	205	15299C205	V262	\$2,189.12
1-1/2"	1/2" (5.6 K)	250	15281C250	V262	\$2,199.59	2-1/2"	1/2" (5.6 K)	250	15299C250	V262	\$2,189.12
1-1/2"	17/32" (8.0 K)	175	15281D175	V262	\$2,199.59	2-1/2"	17/32" (8.0 K)	175	15299D175	V262	\$2,189.12
1-1/2"	17/32" (8.0 K)	205	15281D205	V262	\$2,199.59	2-1/2"	17/32" (8.0 K)	205	15299D205	V262	\$2,189.12
1-1/2"	17/32" (8.0 K)	250	15281D250	V262	\$2,199.59	2-1/2"	17/32" (8.0 K)	250	15299D250	V262	\$2,189.12
1-1/2"	ELO (11.2 K)	175	15281E175	V262	\$2,199.59	2-1/2"	ELO (11.2 K)	175	15298E175	V262	P.O.A.
1-1/2"	ELO (11.2 K)	205	15281E205	V262	\$2,199.59	2-1/2"	ELO (11.2 K)	205	15298E205	V262	P.O.A.
1-1/2"	ELO (11.2 K)	250	15281E250	V262	\$2,199.59	2-1/2"	ELO (11.2 K)	250	15298E250	V262	P.O.A.
						2-1/2"	ESFR (14.0 K)	175	15299F175	V262	\$2,189.12
						2-1/2"	ESFR (14.0 K)	205	15299F205	V262	\$2,189.12
						2-1/2"	ESFR (14.0 K)	250	15299F250	V262	\$2,189.12

(1) Refers to factory pressure setting (psi) of pressure relief valve (PRV). See technical data page # 31 a-e for details.



FLOOR CONTROL (with TESTanDRAIN® and PRV)											
Size	Orifice Size	PRV ¹	Part #	IPG	List Price	Size	Orifice Size	PRV ¹	Part #	IPG	List Price
Groove x Groove (schedule 10)						Groove x Groove (schedule 10)					
3"	3/8" (2.8 K)	175	15302A175	V262	\$2,349.08	6"	3/8" (2.8 K)	175	15296A175	V262	\$3,164.87
3"	3/8" (2.8 K)	205	15302A205	V262	\$2,349.08	6"	3/8" (2.8 K)	205	15296A205	V262	\$3,164.87
3"	3/8" (2.8 K)	250	15302A250	V262	\$2,349.08	6"	3/8" (2.8 K)	250	15296A250	V262	\$3,164.87
3"	7/16" (4.2 K)	175	15302B175	V262	\$2,349.08	6"	7/16" (4.2 K)	175	15296B175	V262	\$3,164.87
3"	7/16" (4.2 K)	205	15302B205	V262	\$2,349.08	6"	7/16" (4.2 K)	205	15296B205	V262	\$3,164.87
3"	7/16" (4.2 K)	250	15302B250	V262	\$2,349.08	6"	7/16" (4.2 K)	250	15296B250	V262	\$3,164.87
3"	1/2" (5.6 K)	175	15302C175	V262	\$2,349.08	6"	1/2" (5.6 K)	175	15296C175	V262	\$3,164.87
3"	1/2" (5.6 K)	205	15302C205	V262	\$2,349.08	6"	1/2" (5.6 K)	205	15296C205	V262	\$3,164.87
3"	1/2" (5.6 K)	250	15302C250	V262	\$2,349.08	6"	1/2" (5.6 K)	250	15296C250	V262	\$3,164.87
3"	17/32" (8.0 K)	175	15302D175	V262	\$2,349.08	6"	17/32" (8.0 K)	175	15296D175	V262	\$3,164.87
3"	17/32" (8.0 K)	205	15302D205	V262	\$2,349.08	6"	17/32" (8.0 K)	205	15296D205	V262	\$3,164.87
3"	17/32" (8.0 K)	250	15302D250	V262	\$2,349.08	6"	17/32" (8.0 K)	250	15296D250	V262	\$3,164.87
3"	ELO (11.2 K)	175	15302E175	V262	\$2,349.08	6"	ELO (11.2 K)	175	15296E175	V262	\$3,164.87
3"	ELO (11.2 K)	205	15302E205	V262	\$2,349.08	6"	ELO (11.2 K)	205	15296E205	V262	\$3,164.87
3"	ELO (11.2 K)	250	15302E250	V262	\$2,349.08	6"	ELO (11.2 K)	250	15296E250	V262	\$3,164.87
3"	ESFR (14.0 K)	175	15302F175	V262	\$2,349.08	6"	ESFR (14.0 K)	175	15296F175	V262	\$3,164.87
3"	ESFR (14.0 K)	205	15302F205	V262	\$2,349.08	6"	ESFR (14.0 K)	205	15296F205	V262	\$3,164.87
3"	ESFR (14.0 K)	250	15302F250	V262	\$2,349.08	6"	ESFR (14.0 K)	250	15296F250	V262	\$3,164.87
3"	ESFR (25.2 K)	175	15302G175	V262	P.O.A.	6"	ESFR (25.2 K)	175	15296G175	V262	\$3,164.87
3"	ESFR (25.2 K)	205	15302G205	V262	P.O.A.	6"	ESFR (25.2 K)	205	15296G205	V262	P.O.A.
3"	ESFR (25.2 K)	250	15302G250	V262	P.O.A.	6"	ESFR (25.2 K)	250	15296G250	V262	P.O.A.
4"	3/8" (2.8 K)	175	15305A175	V262	\$3,014.44	8"	3/8" (2.8 K)	175	15263A175	V262	\$3,494.16
4"	3/8" (2.8 K)	205	15305A205	V262	\$3,014.44	8"	3/8" (2.8 K)	205	15263A205	V262	\$3,494.16
4"	3/8" (2.8 K)	250	15305A250	V262	\$3,014.44	8"	3/8" (2.8 K)	250	15263A250	V262	\$3,494.16
4"	7/16" (4.2 K)	175	15305B175	V262	\$3,014.44	8"	7/16" (4.2 K)	175	15263B175	V262	\$3,494.16
4"	7/16" (4.2 K)	205	15305B205	V262	\$3,014.44	8"	7/16" (4.2 K)	205	15263B205	V262	\$3,494.16
4"	7/16" (4.2 K)	250	15305B250	V262	\$3,014.44	8"	7/16" (4.2 K)	250	15263B250	V262	\$3,494.16
4"	1/2" (5.6 K)	175	15305C175	V262	\$3,014.44	8"	1/2" (5.6 K)	175	15263C175	V262	\$3,494.16
4"	1/2" (5.6 K)	205	15305C205	V262	\$3,014.44	8"	1/2" (5.6 K)	205	15263C205	V262	\$3,494.16
4"	1/2" (5.6 K)	250	15305C250	V262	\$3,014.44	8"	1/2" (5.6 K)	250	15263C250	V262	\$3,494.16
4"	17/32" (8.0 K)	175	15305D175	V262	\$3,014.44	8"	17/32" (8.0 K)	175	15263D175	V262	\$3,494.16
4"	17/32" (8.0 K)	205	15305D205	V262	\$3,014.44	8"	17/32" (8.0 K)	205	15263D205	V262	\$3,494.16
4"	17/32" (8.0 K)	250	15305D250	V262	\$3,014.44	8"	17/32" (8.0 K)	250	15263D250	V262	\$3,494.16
4"	ELO (11.2 K)	175	15305E175	V262	\$3,014.44	8"	ELO (11.2 K)	175	15263E175	V262	\$3,494.16
4"	ELO (11.2 K)	205	15305E205	V262	\$3,014.44	8"	ELO (11.2 K)	205	15263E205	V262	\$3,494.16
4"	ELO (11.2 K)	250	15305E250	V262	\$3,014.44	8"	ELO (11.2 K)	250	15263E250	V262	\$3,494.16
4"	ESFR (14.0 K)	175	15305F175	V262	\$3,014.44	8"	ESFR (14.0 K)	175	15263F175	V262	\$3,494.16
4"	ESFR (14.0 K)	205	15305F205	V262	\$3,014.44	8"	ESFR (14.0 K)	205	15263F205	V262	\$3,494.16
4"	ESFR (14.0 K)	250	15305F250	V262	\$3,014.44	8"	ESFR (14.0 K)	250	15263F250	V262	\$3,494.16
4"	ESFR (25.2 K)	175	15305G175	V262	P.O.A.	8"	ESFR (25.2 K)	175	15263G175	V262	\$3,613.74
4"	ESFR (25.2 K)	205	15305G205	V262	P.O.A.	8"	ESFR (25.2 K)	205	15263G205	V262	\$3,613.74
4"	ESFR (25.2 K)	250	15305G250	V262	P.O.A.	8"	ESFR (25.2 K)	250	15263G250	V262	\$3,613.74

(1) Refers to factory pressure setting (psi) of pressure relief valve (PRV). See technical data page # 31 a-e for details.

TESTanDRAIN® is a registered trademark of AGF Manufacturing, Inc.



FLOOR CONTROL (with TESTanDRAIN® and PRV)											
Size	Orifice Size	PRV ¹	Part #	IPG	List Price	Size	Orifice Size	PRV ¹	Part #	IPG	List Price
Thread x Groove (schedule 40)						Thread x Thread (schedule 40)					
1-1/4"	3/8" (2.8 K)	175	15275A175	V262	\$2,225.91	1-1/4"	3/8" (2.8 K)	175	15269A175	V262	\$2,198.44
1-1/4"	3/8" (2.8 K)	205	15275A205	V262	\$2,225.91	1-1/4"	3/8" (2.8 K)	205	15269A205	V262	\$2,198.44
1-1/4"	3/8" (2.8 K)	250	15275A250	V262	\$2,225.91	1-1/4"	3/8" (2.8 K)	250	15269A250	V262	\$2,198.44
1-1/4"	7/16" (4.2 K)	175	15275B175	V262	\$2,225.91	1-1/4"	7/16" (4.2 K)	175	15269B175	V262	\$2,198.44
1-1/4"	7/16" (4.2 K)	205	15275B205	V262	\$2,225.91	1-1/4"	7/16" (4.2 K)	205	15269B205	V262	\$2,198.44
1-1/4"	7/16" (4.2 K)	250	15275B250	V262	\$2,225.91	1-1/4"	7/16" (4.2 K)	250	15269B250	V262	\$2,198.44
1-1/4"	1/2" (5.6 K)	175	15275C175	V262	\$2,225.91	1-1/4"	1/2" (5.6 K)	175	15269C175	V262	\$2,198.44
1-1/4"	1/2" (5.6 K)	205	15275C205	V262	\$2,225.91	1-1/4"	1/2" (5.6 K)	205	15269C205	V262	\$2,198.44
1-1/4"	1/2" (5.6 K)	250	15275C250	V262	\$2,225.91	1-1/4"	1/2" (5.6 K)	250	15269C250	V262	\$2,198.44
1-1/4"	17/32" (8.0 K)	175	15275D175	V262	\$2,225.91	1-1/4"	17/32" (8.0 K)	175	15269D175	V262	\$2,198.44
1-1/4"	17/32" (8.0 K)	205	15275D205	V262	\$2,225.91	1-1/4"	17/32" (8.0 K)	205	15269D205	V262	\$2,198.44
1-1/4"	17/32" (8.0 K)	250	15275D250	V262	\$2,225.91	1-1/4"	17/32" (8.0 K)	250	15269D250	V262	\$2,198.44
1-1/4"	ELO (11.2 K)	175	15275E175	V262	\$2,225.91	1-1/4"	ELO (11.2 K)	175	15269E175	V262	\$2,198.44
1-1/4"	ELO (11.2 K)	205	15275E205	V262	\$2,225.91	1-1/4"	ELO (11.2 K)	205	15269E205	V262	\$2,198.44
1-1/4"	ELO (11.2 K)	250	15275E250	V262	\$2,225.91	1-1/4"	ELO (11.2 K)	250	15269E250	V262	\$2,198.44
1-1/2"	3/8" (2.8 K)	175	15284A175	V262	\$2,209.66	1-1/2"	3/8" (2.8 K)	175	15278A175	V262	\$2,202.69
1-1/2"	3/8" (2.8 K)	205	15284A205	V262	\$2,209.66	1-1/2"	3/8" (2.8 K)	205	15278A205	V262	\$2,202.69
1-1/2"	3/8" (2.8 K)	250	15284A250	V262	\$2,209.66	1-1/2"	3/8" (2.8 K)	250	15278A250	V262	\$2,202.69
1-1/2"	7/16" (4.2 K)	175	15284B175	V262	\$2,209.66	1-1/2"	7/16" (4.2 K)	175	15278B175	V262	\$2,202.69
1-1/2"	7/16" (4.2 K)	205	15284B205	V262	\$2,209.66	1-1/2"	7/16" (4.2 K)	205	15278B205	V262	\$2,202.69
1-1/2"	7/16" (4.2 K)	250	15284B250	V262	\$2,209.66	1-1/2"	7/16" (4.2 K)	250	15278B250	V262	\$2,202.69
1-1/2"	1/2" (5.6 K)	175	15284C175	V262	\$2,209.66	1-1/2"	1/2" (5.6 K)	175	15278C175	V262	\$2,202.69
1-1/2"	1/2" (5.6 K)	205	15284C205	V262	\$2,209.66	1-1/2"	1/2" (5.6 K)	205	15278C205	V262	\$2,202.69
1-1/2"	1/2" (5.6 K)	250	15284C250	V262	\$2,209.66	1-1/2"	1/2" (5.6 K)	250	15278C250	V262	\$2,202.69
1-1/2"	17/32" (8.0 K)	175	15284D175	V262	\$2,209.66	1-1/2"	17/32" (8.0 K)	175	15278D175	V262	\$2,202.69
1-1/2"	17/32" (8.0 K)	205	15284D205	V262	\$2,209.66	1-1/2"	17/32" (8.0 K)	205	15278D205	V262	\$2,202.69
1-1/2"	17/32" (8.0 K)	250	15284D250	V262	\$2,209.66	1-1/2"	17/32" (8.0 K)	250	15278D250	V262	\$2,202.69
1-1/2"	ELO (11.2 K)	175	15284E175	V262	\$2,209.66	1-1/2"	ELO (11.2 K)	175	15278E175	V262	\$2,202.69
1-1/2"	ELO (11.2 K)	205	15284E205	V262	\$2,209.66	1-1/2"	ELO (11.2 K)	205	15278E205	V262	\$2,202.69
1-1/2"	ELO (11.2 K)	250	15284E250	V262	\$2,209.66	1-1/2"	ELO (11.2 K)	250	15278E250	V262	\$2,202.69
2"	3/8" (2.8 K)	175	15293A175	V262	\$2,200.19	2"	3/8" (2.8 K)	175	15287A175	V262	\$2,209.79
2"	3/8" (2.8 K)	205	15293A205	V262	\$2,200.19	2"	3/8" (2.8 K)	205	15287A205	V262	\$2,209.79
2"	3/8" (2.8 K)	250	15293A250	V262	\$2,200.19	2"	3/8" (2.8 K)	250	15287A250	V262	\$2,209.79
2"	7/16" (4.2 K)	175	15293B175	V262	\$2,200.19	2"	7/16" (4.2 K)	175	15287B175	V262	\$2,209.79
2"	7/16" (4.2 K)	205	15293B205	V262	\$2,200.19	2"	7/16" (4.2 K)	205	15287B205	V262	\$2,209.79
2"	7/16" (4.2 K)	250	15293B250	V262	\$2,200.19	2"	7/16" (4.2 K)	250	15287B250	V262	\$2,209.79
2"	1/2" (5.6 K)	175	15293C175	V262	\$2,200.19	2"	1/2" (5.6 K)	175	15287C175	V262	\$2,209.79
2"	1/2" (5.6 K)	205	15293C205	V262	\$2,200.19	2"	1/2" (5.6 K)	205	15287C205	V262	\$2,209.79
2"	1/2" (5.6 K)	250	15293C250	V262	\$2,200.19	2"	1/2" (5.6 K)	250	15287C250	V262	\$2,209.79
2"	17/32" (8.0 K)	175	15293D175	V262	\$2,200.19	2"	17/32" (8.0 K)	175	15287D175	V262	\$2,209.79
2"	17/32" (8.0 K)	205	15293D205	V262	\$2,200.19	2"	17/32" (8.0 K)	205	15287D205	V262	\$2,209.79
2"	17/32" (8.0 K)	250	15293D250	V262	\$2,200.19	2"	17/32" (8.0 K)	250	15287D250	V262	\$2,209.79
2"	ELO (11.2 K)	175	15293E175	V262	\$2,200.19	2"	ELO (11.2 K)	175	15287E175	V262	\$2,209.79
2"	ELO (11.2 K)	205	15293E205	V262	\$2,200.19	2"	ELO (11.2 K)	205	15287E205	V262	\$2,209.79
2"	ELO (11.2 K)	250	15293E250	V262	\$2,200.19	2"	ELO (11.2 K)	250	15287E250	V262	\$2,209.79

(1) Refers to factory pressure setting (psi) of pressure relief valve (PRV). See technical data page # 31 a-e for details.

TESTanDRAIN® is a registered trademark of AGF Manufacturing, Inc.

EasyPac™ STANDPIPE Assemblies

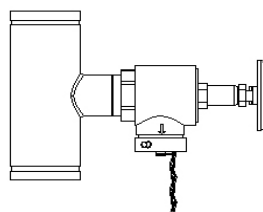
- Pressure Rating: 300 PSI (20.7 bar) max water working pressure.
- Fabricated steel pipe riser bodies with black E-coat.
- Available in grooved inlet and outlet connections (schedule 10 pipe).
- Includes 2-1/2" drain valve with cap and chain.

Standpipe Assemblies			
Size	Part #	IPG	List Price
International			
3"	15576	V253	\$1,338.66
4"	15577	V253	\$1,349.84
6"	15578	V253	\$1,429.74
DOMESTIC¹			
3"	15573	V253	\$2,571.03
4"	15574	V253	\$2,582.20
6"	15575	V253	\$2,662.14

(1) Domestic part numbers include 100% US made components.