



Section M
Dry Pipe Systems

TABLE OF CONTENTS

Dry Pipe System (Model G)..... M-1
Dry Pipe System (Model F) M-2
Accelerators / Air Maintenance Devices M-3
Accessories and Components..... M-4

Notes

1. Refer to Viking technical data pages for complete product specifications. You may print or download technical data by visiting www.vikinggroupinc.com.
2. List prices effective January 11, 2021. Supersedes January 2020 list price book.
3. All sales by Viking are subject to the Terms & Conditions found on the last page of this book.

Model G Dry System (Pre-Assembled) - EXTERNALLY RESETTABLE VALVE



Model G Dry System - EXTERNAL RESET	
<i>Complete, pre-assembled dry valve and trim includes the following:</i>	
- Model G Dry Valve	
- Model G Trim Package	
- Water Supply Control Valve	
- Air Pressure Supervisory Switch (PS40-2A)	
- Alarm Pressure Switch (PS10-1A)	
- 12" (0,3 m) Section of Galvanized Schedule 10 Pipe (with Coupling)	

Model	Size	Part Number	List Price	Item Price Group
G-2000	2"	16149-1	\$9,108.25	V232
G-3000	3"	16150-1	\$9,996.06	V232
G-4000	4"	15647-1	\$10,687.53	V232
G-6000	6"	17048-1	\$12,573.56	V232

Model G Dry System - Optional Drain Manifold Assembly

Model	Size	Part Number	List Price	Item Price Group
G-2000	2"	16211	\$497.90	V232
G-3000	3"	16212	\$640.52	V232
G-4000	4"	15588	\$718.59	V232
G-6000	6"	17056	\$718.59	V232

Model G Dry Systems - DOMESTIC USA OPTION				
Model	Size	Part Number	List Price	Item Price Group
G-2000	2"	16149-1USA	\$9,558.37	V232
G-3000	3"	16150-1USA	\$14,280.06	V232
G-4000	4"	15647-1USA	\$15,267.90	V232
G-6000	6"	17048-1USA	\$17,962.22	V232

See page M-2 for Viking's Model F dry valve and trim.

Model G valve also available in pre-action arrangement. See section O for details.

Domestic trim option meets sourcing requirements of the Buy American Act, American Reinvestment and Recovery Act, and the Buy America Law.

Model F-1 Dry System

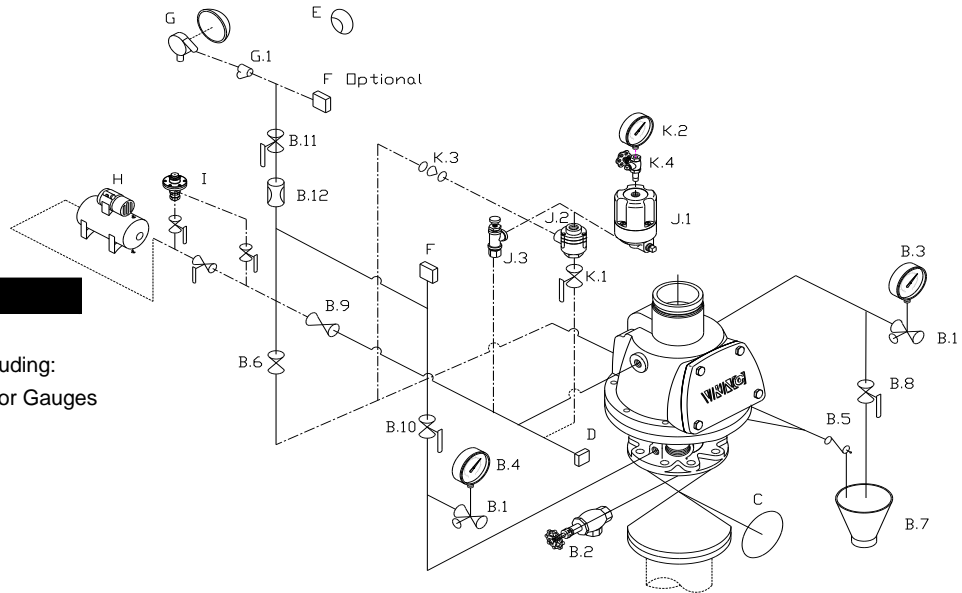

Description

- A Model F-1 Dry Pipe Valve
- B Model F-1 Dry Valve Trim including:
 - B.1 Side Outlet Globe Valve for Gauges
 - B.2 Angle Valve
 - B.3 Air Gauge
 - B.4 Water Gauge
 - B.5 Drip Check Valve
 - B.6 Drain Check Valve
 - B.7 Drain Cup
 - B.8 Priming Water Test Valve
 - B.9 1/2" / DN15 Spring Loaded Check Valve
 - B.10 Alarm Test Valve
 - B.11 Alarm Shut-Off Valve
 - B.12 7/32" / 5mm Restricted Orifice
- C Water Supply Control Valve
- D Air Pressure Supervisory Switch
- E Electric Alarm Bell
- F Alarm Pressure Switch
- G Model F-2 Water Motor Alarm (inc G.1 Y-strainer)
- H Maintenance Air Compressor

Description (continued)

- I Model D-2 Air Maintenance Device and Trim
- J Accelerator / Anti-Flood Package including:
 - J.1 Model E-1 Accelerator
 - J.2 Model B-1 Anti-Flood Device
 - J.3 Model B-1 Float Check Valve Assembly
- K Accelerator / Anti-Flood Trim including:
 - K.1 1/2" / DN15 Anti-Flood Isolation Valve
 - K.2 Air Gauge
 - K.3 1/2" / DN15 Swing Check Valve
 - K.4 Side Outlet Valve for Accelerator Gauge

Trims include indented items immediately following.

Flange / Flange (Model F-1) Dry Valve

Size	Valve (only)		Loose Trim ¹ (galvanized)		Modular Trim ¹ (galvanized)		Valve/Trim (pre-trimmed)	
IPG	V228		V229		V230		V231	
3"	09441	\$4,567.82	10158	\$1,779.01	10158P	\$2,123.22	09441PT	\$6,686.47
4"	07628	\$5,119.50	08395	\$1,817.69	08395P	\$2,162.27	07628PT	\$6,867.56
6"	08464	\$6,401.07	09456	\$1,817.69	09456P	\$2,162.27	08464PT	\$7,608.58

Flange / Groove (Model F-1) Dry Valve

Size	Valve (only)		Loose Trim ¹ (galvanized)		Modular Trim ¹ (galvanized)		Valve/Trim (pre-trimmed)	
IPG	V228		V229		V230		V231	
3"	09446	\$4,567.82	10158	\$1,779.01	10158P	\$2,123.22	09446PT	\$6,791.61
4"	07627	\$5,119.50	08395	\$1,817.69	08395P	\$2,162.27	07627PT	\$7,384.82
6"	08491	\$6,401.07	09456	\$1,817.69	09456P	\$2,162.27	08491PT	\$8,672.56

Groove / Groove (Model F-2) Dry Valve

Size	Valve (only)		Loose Trim ¹ (galvanized)		Modular Trim ¹ (galvanized)		Valve/Trim ² (pre-trimmed)	
IPG	V228		V229		V230		V231	
3"	13764	\$4,567.82	10158	\$1,779.01	10158P	\$2,123.22	13764PTR	\$7,644.88
4"	13765	\$5,119.50	08395	\$1,817.69	08395P	\$2,162.27	13765PTR	\$8,094.56
6"	13766	\$6,401.07	09456	\$1,817.69	09456P	\$2,162.27	13766PTR	\$9,443.66

(1) Trim includes dry valve accessory pkg (p/n 08397). See page M-4 for details.

(2) Pre-assembled with nipples, fittings, water supply control valve, switches, and gauges. See tech data F_122216 for details.



Size	DOMESTIC TRIM ^{1,2}	
IPG	V229	
3"	10158USA	\$2,541.42
4"	08395USA	\$2,596.74
6"	09456USA	\$2,596.74



(2) Meets sourcing requirements of the Buy American Act, American Reinvestment and Recovery Act, and Buy American Law.

See page M-3 for accelerators and air maintenance devices. See page M-4 for additional accessories.



Accelerators / Air Maintenance Devices

Accelerator / Anti-Flood Packages (and Trim)

Accelerator (D-2) 		Model D-2 09881	List Price \$2,007.08		Accelerator Trim (Model D-2) (Galvanized)	Model D-2 09730	List Price \$466.63
					DOMESTIC¹		
					Model D-2 09730USA	List Price \$622.17	

Accelerator (E-1) / Anti-Flood Device (B-1) 		V226	Accelerator / Anti-Flood Trim (galvanized)													
<i>E-1 Accelerator (only)</i> 08055 \$1,671.94			<table border="1"> <thead> <tr> <th colspan="2">STANDARD</th> <th colspan="2">DOMESTIC¹</th> </tr> <tr> <th>Part #</th> <th>List Price</th> <th>Part #</th> <th>List Price</th> </tr> </thead> <tbody> <tr> <td>08264</td> <td>\$670.89</td> <td>08264USA</td> <td>\$894.50</td> </tr> </tbody> </table>		STANDARD		DOMESTIC ¹		Part #	List Price	Part #	List Price	08264	\$670.89	08264USA	\$894.50
STANDARD		DOMESTIC ¹														
Part #	List Price	Part #	List Price													
08264	\$670.89	08264USA	\$894.50													
			Includes: - Air Gauge - ½" / 15mm Anti-Flood Isolation Vlv - ½" / 15mm Swing Check Valve - Nipples, Fittings, Plugs - Float Check Valve													
Accelerator/Anti-Flood Package (include E-1 and B-1)		08116	\$1,979.31	V222												
Use only with tank-mounted air compressor and listed air maintenance device			Use with Model-F dry valve, Model-F dry valve trims, accelerator/anti-flood package													

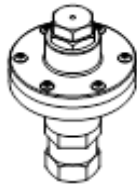
Air Maintenance Device (and trim) - IPG V226

Model D-2 - Air Pressure Maintenance Device 				Model D-2 - Air Pressure Maintenance Device 			
	Size ¼" / DN8	Part # 02280C	List Price \$798.29		Size ½" / DN15	Part # 07459	List Price \$1,402.81
					DOMESTIC¹		
					Size ½" / DN15	Part # 07459USA	List Price \$1,870.41
				Filter Kit V249	Part # 03007A	List Price \$49.80	

Air Compressor - IPG V226

Model G-1 Maintenance Air Compressor (includes mounting bracket)				
	Model		Part #	List Price
	115V single phase, 60 Cycle AC - Service Factor Amperage: 7.4, Factory Wired 115 V		19191	\$3,879.78
	230V single phase, 60 Cycle AC - Service Factor Amperage: 3.7, Factory Wired 230 V		19192	\$3,895.47
	230V single phase, 50 Cycle AC - Service Factor Amperage: 2.6, Factory Wired 230 V		19193	\$3,715.08

(1) Meets sourcing requirements of Buy American Act, American Reinvestment and Recovery Act, and Buy American Law.

Accessories (Included with standard dry valve trim)

<p>Model G Optional Drain Manifold Assembly</p> <p style="text-align: right;">V232</p> <table border="1"> <thead> <tr> <th>Model</th> <th>Size</th> <th>Part Number</th> <th>List Price</th> </tr> </thead> <tbody> <tr> <td>G-2000</td> <td>2"</td> <td>16211</td> <td>\$497.90</td> </tr> <tr> <td>G-3000</td> <td>3"</td> <td>16212</td> <td>\$640.52</td> </tr> <tr> <td>G-4000</td> <td>4"</td> <td>15588</td> <td>\$718.59</td> </tr> <tr> <td>G-6000</td> <td>6"</td> <td>17056</td> <td>\$718.59</td> </tr> </tbody> </table>				Model	Size	Part Number	List Price	G-2000	2"	16211	\$497.90	G-3000	3"	16212	\$640.52	G-4000	4"	15588	\$718.59	G-6000	6"	17056	\$718.59	<p>Dry Valve Accessory Package</p> <p>Includes:</p> <ul style="list-style-type: none"> - Drip Check Valve - Drain Cup - Valve Reset Bar - 7/32" / 5mm Restricted Orifice - 1/2" / 15mm Spring Loaded Check Valve - 1/4" / 8mm Restricted Orifice - Tubing Connector <table border="1"> <thead> <tr> <th>Part Number</th> <th>List Price</th> </tr> </thead> <tbody> <tr> <td>08397</td> <td>\$659.29</td> </tr> </tbody> </table> <p style="text-align: right;">IPG V226</p>				Part Number	List Price	08397	\$659.29
Model	Size	Part Number	List Price																												
G-2000	2"	16211	\$497.90																												
G-3000	3"	16212	\$640.52																												
G-4000	4"	15588	\$718.59																												
G-6000	6"	17056	\$718.59																												
Part Number	List Price																														
08397	\$659.29																														
<p>Water Gauge 0-300 psi (2,068 kPa)</p> <p>1/4" / DN8 VWATERSF \$27.45 SR295</p>		<p>Air Gauge 0-80 psi (554 kPa)</p> <p>1/4" / DN8 VAIRSF \$27.45 SR295</p>		<p>Globe Valve for Gauges (side outlet)</p> <p>1/4" / DN8 76V-25 \$21.58 SR140</p>																											
<p>Alarm Test/Alarm Shut-Off Valve (1/2" Ball Valve)</p> <p>1/2" / DN15 10355USA \$36.35 V226</p>		<p>Drain Cup</p> <p>1 1/2" / DN40 01019B \$20.23 V226</p>		<p>Drain Check Valve</p> <p>1/2" / DN15 05781A \$105.12 V226</p>																											
<p>Drip Check Valve - Model D-3 Velocity Check</p> <p>3/4" / DN20 10732 \$187.81 V226</p>		<p>Dry Valve Wrench & Reset Bar</p> <p>02977BWB \$256.57 V226</p>		<p>Swing Check Valve</p> <p>1/2" / DN15 KT403W-50 \$92.73 SR140</p>																											
<p>Restricted Orifice 1/16" / 1.5mm</p> <p>1/4" / DN8 10110 \$40.87 V226</p>		<p>Restricted Orifice 7/32" / 5mm</p> <p>1/2" / DN15 06980A \$22.38 V226</p>																													
<p>Angle Valve 1 1/2" / DN40</p> <p>Use with 3" 03937S \$222.36</p> <p>2" / DN50</p> <p>Use with 4" 126SUL-0200 \$175.09</p> <p>Use with 6" 126SUL-0200 \$175.09</p>		<p>Anti-Column Device (Model LD-1)</p> <p>14800 \$537.28</p> <p>*install in vertical position</p> <p style="text-align: right;">V226</p> <p style="text-align: center;"><i>Install on dry systems where potential for water column exists downstream of dry valve</i></p>		<p>Anti-Column Device Trim</p> <p>14816 \$205.66 V226</p>																											
<p>Float Check Valve (Model B-1/B-2)</p> <table border="1"> <thead> <tr> <th colspan="2">Brass - 1/2" / DN15 (B-1)</th> <th colspan="2">Corrosion Resistant (B-2)</th> </tr> </thead> <tbody> <tr> <td>12116</td> <td>\$347.33</td> <td>12084</td> <td>\$850.44</td> </tr> </tbody> </table> <p style="text-align: right;">V226</p>						Brass - 1/2" / DN15 (B-1)		Corrosion Resistant (B-2)		12116	\$347.33	12084	\$850.44																		
Brass - 1/2" / DN15 (B-1)		Corrosion Resistant (B-2)																													
12116	\$347.33	12084	\$850.44																												

Accessories (NOT included with standard dry valve trim)

<p>Dry Valve Wrench & Reset Bar</p> <p>02977BWB \$256.57 V226</p>		<p>Glass Strut Head (for Model B-1 accelerator)</p> <p>03226C \$74.81 V249</p>		<p>Drip Check Valve (Model D-2) (for Model B-1 accelerator)</p> <p>10731 \$293.69 V226</p>	
--	--	---	--	---	--