



Section P
Flow Control and Pressure Regulation

TABLE OF CONTENTS

Flow Control System	P-1 – P-2
Pressure Regulation System.....	P-3
Alarm Devices.....	P-4
Pilot Operated Pressure Control Valves / Trim	P-5 – P-6
Special Valves and Trim (Halar® coated valves, brass trim, etc.)	P-7 – P-9

Notes

1. Refer to Viking technical data pages for complete product specifications. You may print or download technical data by visiting www.vikinggroupinc.com.
2. List prices effective July 9, 2022. Supersedes February 2022 list price book.
3. All sales by Viking are subject to the Terms & Conditions found on the last page of this book.

Flow Control System

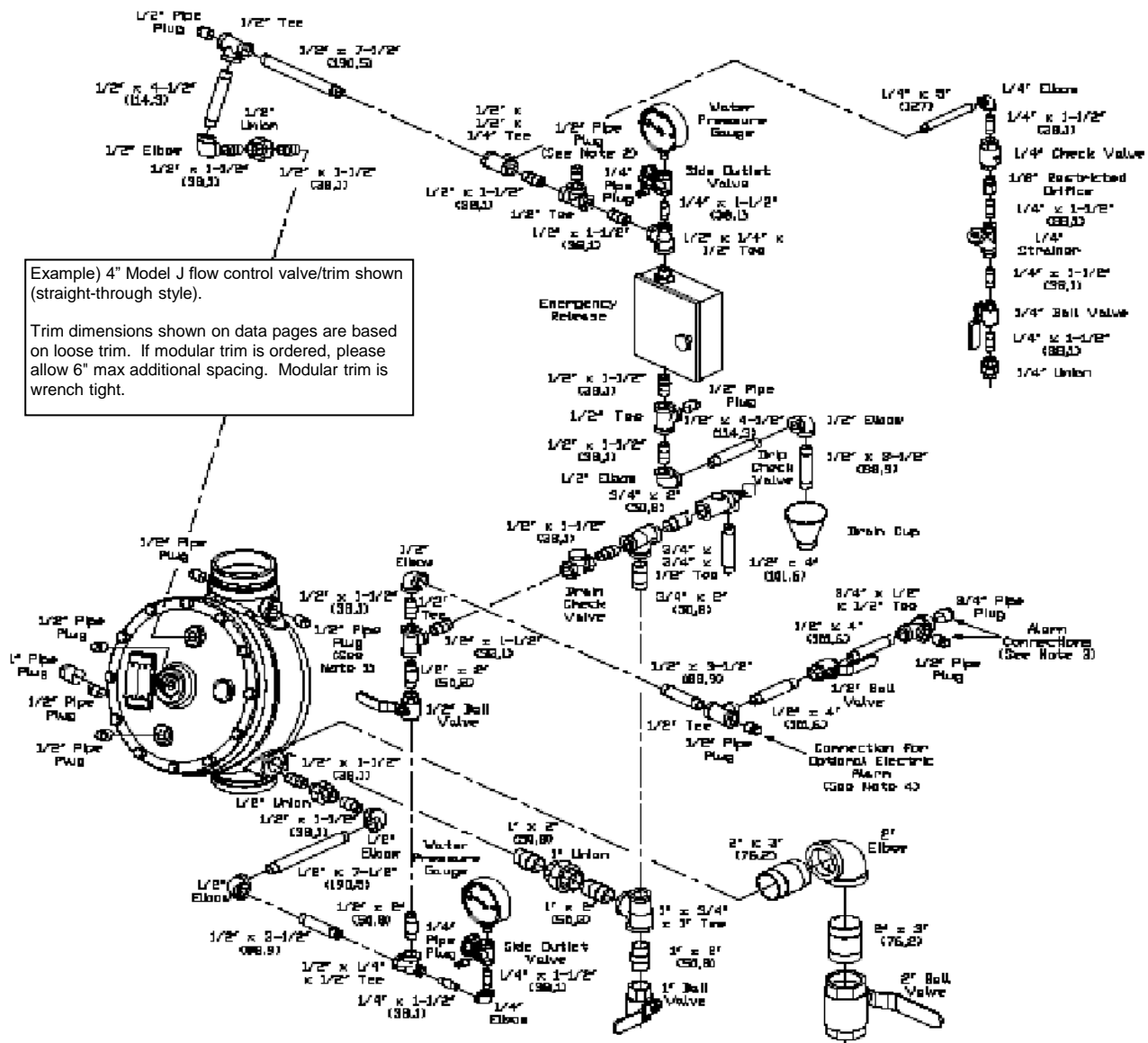

Example 4\" Model J flow control valve/trim shown (straight-through style).
 Trim dimensions shown on data pages are based on loose trim. If modular trim is ordered, please allow 6\" max additional spacing. Modular trim is wrench tight.

Model J Flow Control Valve* - STRAIGHT THROUGH

IPG 244	1-1/2\"	2\"	2-1/2\"	3\"	4\"	6\"	8\"
Thread X Thread	<u>12130</u> \$5,306.99	<u>12063</u> \$5,477.40	<u>12405</u> \$6,944.08	N/A	N/A	N/A	N/A
Flange X Flange	N/A	N/A	N/A	<u>12016</u> \$6,944.08	<u>11968</u> \$8,750.21	<u>11970</u> \$11,683.53	<u>11993</u> \$25,171.28
Flange X Groove	N/A	N/A	N/A	<u>12020</u> \$6,944.08	<u>11967</u> \$8,750.21	<u>11969</u> \$11,683.53	N/A
Groove X Groove	<u>12129</u> \$5,306.99	<u>12061</u> \$5,477.40	<u>12407</u> \$6,944.08	<u>12024</u> \$6,944.08	<u>11516</u> \$8,750.21	<u>11527</u> \$11,683.53	<u>11019</u> \$22,064.74

Model H Flow Control Valve* - ANGLE STYLE

IPG 244.1	1-1/2\"	2\"	3\"	4\"	6\"
Thread X Thread	<u>09894</u> \$2,577.85	<u>05856C</u> \$5,896.58	N/A	N/A	N/A
Flange X Flange	N/A	N/A	<u>05914C</u> \$7,475.51	<u>05911C</u> \$9,419.84	<u>05908C</u> \$12,577.65
Flange X Groove	N/A	N/A	<u>05837C</u> \$7,475.51	<u>05841C</u> \$9,419.84	<u>05458C</u> \$12,577.65

See page P-7-8 for additional valve and trim options, including Halar® coated valves, horizontal trim, and brass trim packages.

* Valve is not included in trim packages. Please order separately. See following page for trim packages and equipment.

Flow Control System

TrimPac® V234	1-1/2"	2"	2-1/2"	3"	4"	6"	8"
Angle/Straight-Through <i>(includes release / trim)</i>	12252C-1 \$6,336.44	12252C-1 \$6,336.44	12252C-1 \$6,336.44	12252C-1 \$6,336.44	12252C-1 \$6,336.44	12252C-1 \$6,336.44	12252C-1 \$6,336.44

TrimPac includes conventional trim, releasing device (solenoid valve), releasing trim, and flexible hose kit.
Drain package for TrimPac must be ordered separately (see below).

Drain Package (IPG V257)

Use with TrimPac® <i>(order separately)</i>	11894-1 \$738.33	11894-2 \$597.20	11894-3 \$676.78	11894-3 \$676.78	11894-4 \$868.61	11894-4 \$868.61	11894-4 \$868.61
--	---------------------	---------------------	---------------------	---------------------	---------------------	---------------------	---------------------

1-1/2"	2"	2-1/2"	3"	4"	6"	8"
--------	----	--------	----	----	----	----

Vertical Trim (Straight Through) - Galvanized (IPG V245)

Loose Trim <i>(incl. accessory pkg-09316)</i>	12418-1 \$3,833.53	12418-1 \$3,833.53	12306-1 \$3,613.83	12306-1 \$3,613.83	11719-1 \$3,835.25	11720-1 \$3,835.25	14708-1 \$4,545.92
Modular Trim <i>(incl. accessory pkg-09316)</i>	12418-1P \$4,257.05	12418-1P \$4,257.05	12306-1P \$4,037.34	12306-1P \$4,037.34	11719-1P \$4,258.72	11720-1P \$4,258.72	14708-1P \$4,971.37

Vertical Trim (Angle Style) - Galvanized (IPG V245)

Loose Trim <i>(incl. accessory pkg-09316)</i>	14702-1 \$4,014.37	14703-1 \$3,699.80	N/A	14704-1 \$3,784.31	14705-1 \$4,016.13	14706-1 \$4,016.13	N/A
Modular Trim <i>(incl. accessory pkg-09316)</i>	14702-1P \$4,451.65	14703-1P \$4,025.26	N/A	14704-1P \$4,221.61	14705-1P \$4,453.43	14706-1P \$4,453.43	N/A

1-1/2"	2"	2-1/2"	3"	4"	6"	8"
--------	----	--------	----	----	----	----

Releasing Devices (IPG V240)

Solenoid Valve	11601 \$1,345.64	11601 \$1,345.64	11601 \$1,345.64	11601 \$1,345.64	11601 \$1,345.64	11601 \$1,345.64	11601 \$1,345.64
----------------	---------------------	---------------------	---------------------	---------------------	---------------------	---------------------	---------------------

Releasing Trim - Galvanized (IPG V238)

Loose Trim <i>(releasing device not incl.)</i>	10830 \$140.24	10830 \$140.24	10830 \$140.24	10830 \$140.24	10830 \$140.24	10830 \$140.24	10830 \$140.24
Modular Trim <i>(releasing device not incl.)</i>	10830P \$605.38	10830P \$605.38	10830P \$605.38	10830P \$605.38	10830P \$605.38	10830P \$605.38	10830P \$605.38
Loose Trim - DOMESTIC <i>(releasing device not incl.)</i>	10830USA \$186.96	10830USA \$186.96	10830USA \$186.96	10830USA \$186.96	10830USA \$186.96	10830USA \$186.96	10830USA \$186.96

Trim packages include flow control accessory package listed below (p/n 10685) - see package detail below

See page P-7/8 for additional valve and trim options, including Halar® coated valves, horizontal trim, and brass trim packages.

Flow Control Valve Accessory Package (INCLUDED WITH TRIM)		
<i>(all sizes)</i>	10685	\$3,102.90
corrosion resistant	09743	\$4,327.71
Includes:		
- 1/8" Restricted Orifice		
- Emergency Release		
- Drip Check		
- 1/4" / 8mm Check Valve		
- 1/4" / 8mm Strainer		
- Drain Cup		
- 1/2" Ball Valve		
- Drain Check		
IPG V226		

TrimPac® - Air Line Trim		
<i>(not for use with Deluge TrimPac System)</i>		
Tank Mounted	13770	\$2,470.23
Tankless	13771	\$870.94
IPG V234		
TrimPac® - Replacement Hose		
PVC drain hose	12071	\$196.74
IPG V234		
TrimPac® - Riser Mounting Kit		
<i>(use when mounting TrimPac unit to riser)</i>		
Vertical	11900	\$1,366.22
Horizontal	11901	\$1,878.64
IPG V234		

Pressure Regulation

Viking's pressure regulation trim packages include both conventional trim (deluge or flow control) and pilot regulator trim, as well as the speed control needle valve and pilot pressure regulating valve. Pilot regulator trim is no longer available separately. To order a complete pressure regulation system, first order a deluge or flow control valve, then the appropriate pressure regulation trim listed below, and finally your desired releasing device and trim.

Pressure Regulating Trim for DELUGE/PREACTION SYSTEMS (includes conventional trim)

	1-1/2"	2"	2-1/2"	3"	4"	6"	8"
For Straight Through Valves - Vertical/Galvanized Trim (IPG V250)							
Loose Trim	<u>14746-1</u> \$8,215.91	<u>14746-1</u> \$8,215.91	<u>14747-1</u> \$8,300.85	<u>14747-1</u> \$8,300.85	<u>14748-1</u> \$8,682.43	<u>14749-1</u> \$8,668.21	<u>14713-1</u> \$8,680.47
Modular Trim	<u>14746-1P</u> \$8,754.07	<u>14746-1P</u> \$8,754.07	<u>14747-1P</u> \$8,840.36	<u>14747-1P</u> \$8,840.36	<u>14748-1P</u> \$9,227.81	<u>14749-1P</u> \$9,572.88	<u>14713-1P</u> \$9,585.82

For Angle Style Valves - Vertical/Galvanized Trim (IPG V236)

Loose Trim	N/A	<u>14715-1</u> \$8,398.90	N/A	<u>14716-1</u> \$8,426.33	<u>14717-1</u> \$8,718.98	<u>14718-1</u> \$8,987.31	N/A
Modular Trim	N/A	<u>14715-1P</u> P.O.A.	N/A	<u>14716-1P</u> P.O.A.	<u>14717-1P</u> \$9,881.98	<u>14718-1P</u> \$9,909.53	N/A

Pressure Regulating Trim for FLOW CONTROL SYSTEMS (includes conventional trim)

	1-1/2"	2"	2-1/2"	3"	4"	6"	8"
For Straight Through Valves - Vertical/Galvanized Trim (IPG V238)							
Loose Trim	<u>14768-1</u> \$8,668.11	<u>14768-1</u> \$8,668.11	<u>14769-1</u> \$8,757.75	<u>14769-1</u> \$8,757.75	<u>14770-1</u> \$9,160.30	<u>14771-1</u> \$9,145.31	<u>14772-1</u> \$9,158.26
Modular Trim	<u>14768-1P</u> \$9,095.70	<u>14768-1P</u> \$9,095.70	<u>14769-1P</u> \$9,185.34	<u>14769-1P</u> \$9,185.34	<u>14770-1P</u> \$9,587.88	<u>14771-1P</u> \$9,572.88	<u>14772-1P</u> \$9,585.82

For Angle Style Valves - Vertical/Galvanized Trim (IPG V238)

Loose Trim	N/A	<u>14764-1</u> \$9,107.33	N/A	<u>14765-1</u> \$9,137.06	<u>14766-1</u> \$9,414.77	<u>14767-1</u> \$9,481.97	N/A
Modular Trim	N/A	<u>14764-1P</u> P.O.A.	N/A	<u>14765-1P</u> \$9,572.70	<u>14766-1P</u> \$9,850.40	<u>14767-1P</u> P.O.A.	N/A

	1-1/2"	2"	2-1/2"	3"	4"	6"	8"
Releasing Devices (IPG V240)							
Solenoid Valve	<u>11601</u> \$1,345.64	<u>11601</u> \$1,345.64	<u>11601</u> \$1,345.64	<u>11601</u> \$1,345.64	<u>11601</u> \$1,345.64	<u>11601</u> \$1,345.64	<u>11601</u> \$1,345.64

Releasing Trim - Galvanized (IPG V238)



Loose Trim (releasing device not incl.)	<u>10830</u> \$140.24	<u>10830</u> \$140.24	<u>10830</u> \$140.24	<u>10830</u> \$140.24	<u>10830</u> \$140.24	<u>10830</u> \$140.24	<u>10830</u> \$140.24
Modular Trim (releasing device not incl.)	<u>10830P</u> \$605.38	<u>10830P</u> \$605.38	<u>10830P</u> \$605.38	<u>10830P</u> \$605.38	<u>10830P</u> \$605.38	<u>10830P</u> \$605.38	<u>10830P</u> \$605.38

Speed Control Assembly use with conventional trim	IPG V244	Pilot Pressure Regulating Valve (C-2)		Speed Control Valve					
	Galvanized	08780	\$2,219.48		10799	\$1,701.58	08313	\$577.49	
	Stainless Steel	11192	\$13,060.54						
	Brass	11181	\$2,615.07						
							Y Strainer		
							1/2" / 15mm	01054A	\$172.47

See page P-7/8 for additional valve and trim options, including Halar® coated valves, horizontal trim, and brass trim packages.

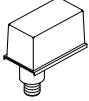

Alarm Devices

Alarm Pressure Switch - SR020

<u>Adjustable Range (4-20 psi)</u> <u>1/2" / DN50</u> Single SPDT PS101A \$269.05 Dual SPDT PS102A \$324.36 * Manufactured by Potter			<u>Explosion Proof</u> Dual SPDT PS10-EX \$1,894.79 Dual SPDT PS40EX \$1,894.79 * Cenelec approved		
					
<u>Pressure Adj Access Key</u> 10600 \$38.42			<u>Cover Removal Key</u> 10601 \$38.42		

* Appropriate hex keys included with switches.

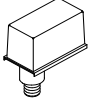
Pressure Supervisory Switch (Air, Nitrogen, Water) - IPG SR020



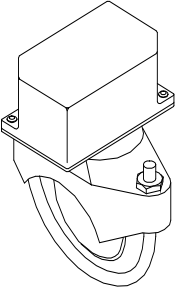

<u>Adjustable Range (10-175 psi)</u> <u>1/2" / DN50</u> Single SPDT PS401A \$269.05 Dual SPDT PS402A \$324.36 * Manufactured by Potter			<u>Explosion Proof</u> Dual SPDT 10379 \$2,531.67 * Cenelec approved		
					
<u>Cover Tamper Switch Kit</u> 09601 \$196.51			<u>Pressure Adj Access Key</u> 10600 \$38.42 <u>Cover Removal Key</u> 10601 \$38.42		

* Appropriate hex keys included with switches.

Flow Switch - SR010

<u>Waterflow Indicators</u> (adjustable retard up to 120 sec. - 2 SPDT contacts) <u>Model VSR</u>			
1-2" / DN40	VSRF0100	\$390.46	
2" / DN50	VSRF0200	\$422.48	
2½" / DN65	VSRF0250	\$422.48	
3" / DN80	VSRF0300	\$422.48	
3½" / DN90	VSRF0350	\$422.48	
4" / DN100	VSRF0400	\$422.48	
5" / DN125	VSRF0500	\$422.48	
6" / DN150	VSRF0600	\$422.48	
8" / DN200	VSRF0800	\$473.72	

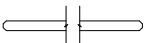
Water Motor Alarm and Accessories - IPG V226

<u>Water Motor Alarm</u>  Model F-2 07862 \$873.25		<u>Closure Plate</u>  05820B \$178.23	
<u>Adjustable Shaft</u> (wall thickness up to 30-1/4 in / 768 mm)  03312B \$171.00		<u>Alarm Line Y Strainer</u>  ¾" (DN20) 01489A \$260.03	
<u>Extension Cup</u>  05957B \$142.59			

Pilot Operated Pressure Control Valves

Threaded

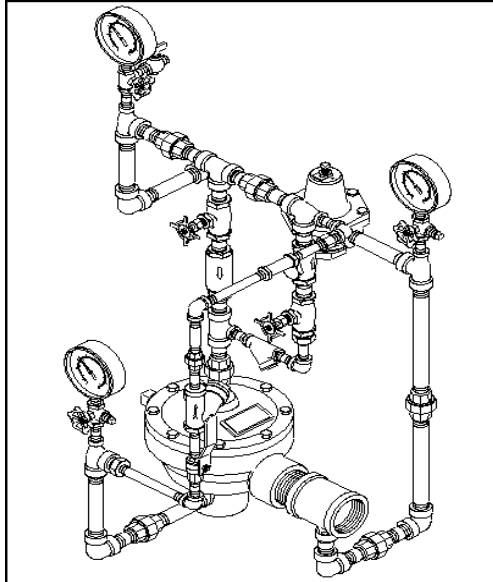

Flange/Flange

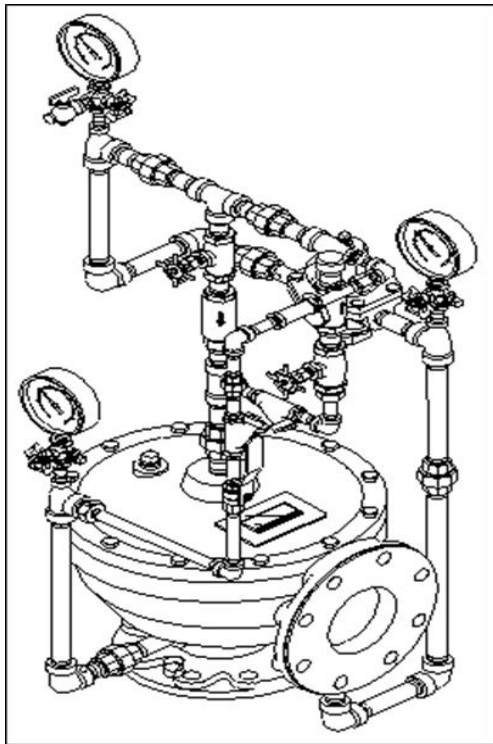

Flange/Groove

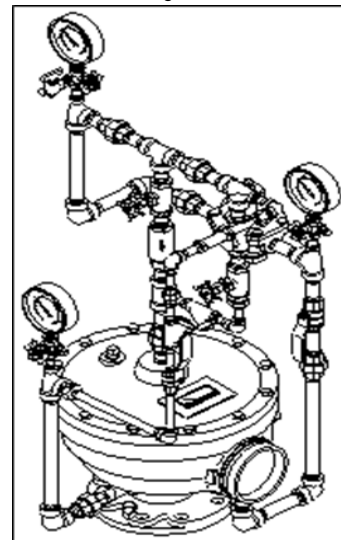

DESCRIPTION	NOMINAL SIZE	PART NUMBER	LIST PRICE (each)	
PILOT OPERATED PRESSURE CONTROL VALVES Includes Trim	Use with Angle Style Valve			
	Model A-2 Galvanized Model A-3 Brass Model A-4 Stainless Steel			
	Threaded	Model A-2 2" / DN50	10793	\$16,204
	Flange/Flange	Model A-2 4" / DN100	10795	\$16,204
		6" / DN150	10807	\$19,116
	PN10/16	DN100	10795FFPN1016	\$16,204
	PN10/16	DN150	10807FFPN1016	\$19,116
	PN10/16	Model A-3 4" / DN100	10803	\$32,402
		6" / DN150	11476	\$38,833
	PN10/16	DN100	10803FFPN1016	\$32,402
	PN10/16	DN150	11476FFPN1016	\$38,833
	Flange/Groove	Model A-2 4" / DN100	10794	\$16,204
6" / DN150		10806	\$19,116	
IPG V244	Model A-3 4" / DN100	10802	\$32,119	
	6" / DN150	11475	\$38,541	

¹ Not UL Listed. Use for Deluge Applications Only.

Pilot Operated Pressure Control Valves

DESCRIPTION	Nominal Size	Part No.	List Price	DESCRIPTION	Nominal Size	Part No.	List Price
Pilot Operated Pressure Control Valves	Use with Straight Through Valves			Pilot Operated Pressure Control Valves	Use with Straight Through Valves		
Includes trim UL Listed/FM Approved				Halar® Coated (includes trim) UL Listed/FM Approved			
Model B-1				Model B-3			
Vertical				Vertical			
Threaded	Galvanized			Flange/Flange	Brass		
	2" / DN50	12793	\$7,558		4" / DN100	13540	\$53,049
Flange/Flange					6" / DN150	13543	\$68,034
	4" / DN100	12802	\$17,086		8" / DN200	13545	\$84,857
	6" / DN150	12805	\$21,968	Flange/Groove			
	8" / DN200	12807	\$27,559		4" / DN100	13539	\$52,942
Flange/Groove					6" / DN150	13542	\$67,374
	4" / DN100	12801	\$17,051	Groove/Groove			
	6" / DN150	12804	\$21,751		1½" / DN40	13532	\$22,651
Groove/Groove					2" / DN50	13533	\$22,941
	1½" / DN40	12792	\$7,463		4" / DN100	13538	\$54,586
	2" / DN50	12794	\$7,558		6" / DN150	13541	\$66,972
					8" / DN200	13544	\$81,144
IPG V238				IPG V239			
Horizontal				Horizontal			
Threaded	Galvanized			Flange/Flange	Brass		
	4" / DN100	12800	\$10,972		4" / DN100	13526	\$31,917
	6" / DN150	12803	\$21,619		6" / DN150	13529	\$68,212
	8" / DN200	12806	\$26,339		8" / DN200	13531	\$85,286
Flange/Flange				Flange/Groove			
	4" / DN100	12785	\$9,902		4" / DN100	13525	\$31,810
	6" / DN150	12788	\$21,972		6" / DN150	13528	\$67,551
	8" / DN200	12790	\$27,565	Groove/Groove			
Flange/Groove					1½" / DN40	13518	\$22,697
	4" / DN100	12784	\$10,458		2" / DN50	13519	\$22,988
	6" / DN150	12787	\$21,755		4" / DN100	13524	\$33,454
Groove/Groove					6" / DN150	13527	\$67,149
	1½" / DN40	12775	\$7,448		8" / DN200	13530	\$81,573
	2" / DN50	12777	\$7,543	IPG V239			
	4" / DN100	12783	\$10,998				
	6" / DN150	12786	\$21,623				
	8" / DN200	12789	\$26,345				
IPG V238							

**Model B-1 - Horizontal
Flange/Flange**

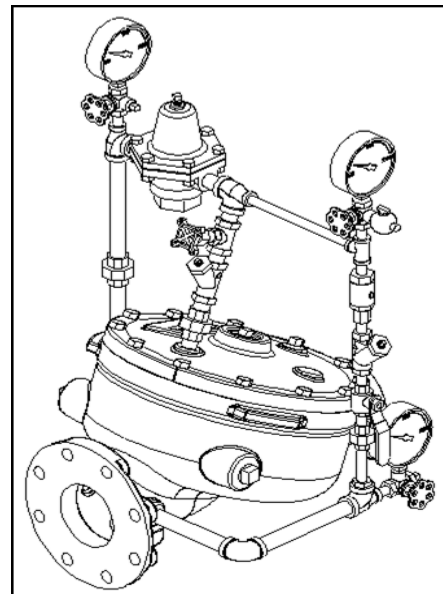

FLOW CONTROL - Special Valves and Trim

Halar® Coated Flow Control Valves (Model J-2 / Model H-2)

Straight-Through (Model J-2)

IPG V244	1-1/2"	2"	2-1/2"	3"	4"	6"	8"
Thread X Thread	N/A	N/A	<u>12406Q/B</u> \$10,504.32	N/A	N/A	N/A	N/A
Flange X Flange	N/A	N/A	N/A	<u>12017Q/B</u> \$10,504.32	<u>11977Q/B</u> \$13,028.29	<u>11979Q/B</u> \$17,352.18	<u>11994Q/B</u> \$34,335.36
Flange X Groove	N/A	N/A	N/A	<u>12021Q/B</u> \$10,504.32	<u>11976Q/B</u> \$13,028.29	<u>11978Q/B</u> \$17,352.18	N/A
Groove X Groove	<u>12131Q/B</u> \$8,237.62	<u>12062Q/B</u> \$8,259.95	<u>12408Q/B</u> \$10,504.32	<u>12025Q/B</u> \$10,504.32	<u>11517Q/B</u> \$13,028.29	<u>11528Q/B</u> \$17,352.18	<u>11119Q/B</u> \$33,437.67

Angle Style (Model H-2)

IPG V244.1	1-1/2"	2"	2-1/2"	3"	4"	6"	8"
Thread X Thread	N/A	N/A	N/A	N/A	N/A	N/A	N/A
Flange X Flange	N/A	N/A	N/A	<u>08366Q/B</u> \$11,308.24	<u>08367Q/B</u> \$14,025.39	<u>08368Q/B</u> \$18,680.11	N/A
Flange X Groove	N/A	N/A	N/A	<u>11207Q/B</u> \$11,308.24	<u>11208Q/B</u> \$14,025.39	<u>11209Q/B</u> \$18,170.66	N/A

HORIZONTAL TRIM - Flow Control

Galvanized (use with straight through valves)

IPG V245	1-1/2"	2"	2-1/2"	3"	4"	6"	8"
<u>Loose Trim</u> (incl. accessory pkg-09316)	<u>12419-1</u> \$3,833.53	<u>12419-1</u> \$3,833.53	<u>12307-1</u> \$3,613.83	<u>12307-1</u> \$3,613.83	<u>11941-1</u> \$3,835.25	<u>11942-1</u> \$3,835.25	<u>14707-1</u> \$4,545.92
<u>Modular Trim</u> (incl. accessory pkg-09316)	<u>12419-1P</u> \$4,224.93	<u>12419-1P</u> \$4,224.93	<u>12307-1P</u> P.O.A.	<u>12307-1P</u> P.O.A.	<u>11941-1P</u> \$4,258.72	<u>11942-1P</u> \$4,258.72	<u>14707-1P</u> \$4,971.37

BRASS TRIMS - Flow Control

Angle Style Valves

IPG V246	1-1/2"	2"	2-1/2"	3"	4"	6"	8"
<u>Loose Trim</u> (incl. accessory pkg-09316)	<u>14702-2</u> \$6,330.21	<u>14703-2</u> \$5,899.31	N/A	<u>14704-2</u> \$6,059.20	<u>14705-2</u> \$6,631.20	<u>14706-2</u> \$6,703.29	N/A
<u>Modular Trim</u> (incl. accessory pkg-09316)	<u>14702-2P</u> P.O.A.	<u>14703-2P</u> P.O.A.	N/A	<u>14704-2P</u> P.O.A.	<u>14705-2P</u> P.O.A.	<u>14706-2P</u> P.O.A.	N/A

Straight Through Valves - VERTICAL

IPG V246	1-1/2"	2"	2-1/2"	3"	4"	6"	8"
<u>Loose Trim</u> (incl. accessory pkg-09316)	<u>12418-2</u> \$6,045.07	<u>12418-2</u> \$6,045.07	<u>12306-2</u> \$5,786.31	<u>12306-2</u> \$5,786.31	<u>11719-2</u> \$6,332.48	<u>11720-2</u> \$6,401.36	<u>14708-2</u> \$7,766.64
<u>Modular Trim</u> (incl. accessory pkg-09316)	<u>12418-2P</u> \$6,484.88	<u>12418-2P</u> \$6,484.88	<u>12306-2P</u> \$6,226.07	<u>12306-2P</u> \$6,226.07	<u>11719-2P</u> \$6,772.26	<u>11720-2P</u> \$6,841.14	<u>14708-2P</u> \$8,206.40

Straight Through Valves - HORIZONTAL

IPG V246	1-1/2"	2"	2-1/2"	3"	4"	6"	8"
<u>Loose Trim</u> (incl. accessory pkg-09316)	<u>12419-2</u> \$6,045.07	<u>12419-2</u> \$6,045.07	<u>12307-2</u> \$5,786.31	<u>12307-2</u> \$5,786.31	<u>11941-2</u> \$6,332.48	<u>11942-2</u> \$6,401.36	<u>14707-2</u> \$7,766.64
<u>Modular Trim</u> (incl. accessory pkg-09316)	<u>12419-2P</u> P.O.A.	<u>12419-2P</u> P.O.A.	<u>12307-2P</u> P.O.A.	<u>12307-2P</u> P.O.A.	<u>11941-2P</u> \$6,772.26	<u>11942-2P</u> \$6,841.14	<u>14707-2P</u> \$8,206.40

Special Valves and Trim

BRASS - Releasing Trims

IPG V239	Pneumatic	Electric Pneumatic	Electric	Pneumatic Pneumatic	<u>DOMESTIC¹</u> Electric
	Loose Trim <i>(releasing device not incl.)</i>	<u>10811</u> \$370.11	<u>12661-2</u> \$308.95	<u>10832</u> \$416.45	<u>12662-2</u> \$1,971.20
Modular Trim <i>(releasing device not incl.)</i>	<u>10811P</u> \$809.80	<u>126612P</u> P.O.A.	<u>10832P</u> P.O.A.	<u>126622P</u> P.O.A.	<u>10832USA-P</u> P.O.A.

(1) Meets sourcing requirements of the Buy American Act, American Reinvestment and Recovery Act, and the Buy American Law. Contact customer service for availability

PRESSURE REGULATION - Special Trims

Viking's new pressure regulation trim packages include both conventional trim (deluge or flow control) and pilot regulator trim, as well as the speed control needle valve and pilot pressure regulating valve. Pilot regulator trim is no longer available separately. To order a complete pressure regulation system, first order a deluge or flow control valve, then the appropriate pressure regulation trim listed below, and finally your desired releasing device and trim.

HORIZONTAL TRIM - Pressure Regulating Trim for DELUGE/PREACTION SYSTEMS (includes conventional trim)

	1-1/2"	2"	2-1/2"	3"	4"	6"	8"
For Straight Through Valves - Horizontal/Galvanized Trim (IPG V36)							
<u>Loose Trim</u>	<u>14750-1</u> \$8,197.47	<u>14750-1</u> \$8,197.47	<u>14751-1</u> \$8,295.43	<u>14751-1</u> \$8,295.43	<u>14752-1</u> \$8,615.91	<u>14753-1</u> \$8,549.65	<u>14714-1</u> \$8,657.53
<u>Modular Trim</u>	<u>14750-1P</u> P.O.A.	<u>14750-1P</u> P.O.A.	<u>14751-1P</u> P.O.A.	<u>14751-1P</u> P.O.A.	<u>14752-1P</u> \$9,021.18	<u>14753-1P</u> \$8,954.92	<u>14714-1P</u> P.O.A.

BRASS TRIMS - Pressure Regulating Trim for DELUGE/PREACTION SYSTEMS (includes conventional trim)

	1-1/2"	2"	2-1/2"	3"	4"	6"	8"
For Straight Through Valves - Vertical/Brass Trim (IPG V237)							
<u>Loose Trim</u>	<u>14746-2</u> \$10,289.33	<u>14746-2</u> \$10,289.33	<u>14747-2</u> \$10,597.22	<u>14747-2</u> \$10,597.22	<u>14748-2</u> \$11,359.63	<u>14749-2</u> \$11,302.98	<u>14713-2</u> \$11,302.05
<u>Modular Trim</u>	<u>14746-2P</u> \$10,716.83	<u>14746-2P</u> \$10,716.83	<u>14747-2P</u> \$11,024.73	<u>14747-2P</u> \$11,024.73	<u>14748-2P</u> \$11,787.11	<u>14749-2P</u> P.O.A.	<u>14713-2P</u> P.O.A.

For Angle Style Valves - Vertical/Brass Trim (IPG V237)

<u>Loose Trim</u>	N/A	<u>14715-2</u> \$10,949.33	N/A	<u>14716-2</u> \$10,911.36	<u>14717-2</u> \$11,592.15	<u>14718-2</u> \$11,738.87	N/A
<u>Modular Trim</u>	N/A	<u>14715-2P</u> P.O.A.	N/A	<u>14716-2P</u> \$11,043.96	<u>14717-2P</u> P.O.A.	<u>14718-2P</u> P.O.A.	N/A

BRASS TRIMS - Pressure Regulating Trim for FLOW CONTROL SYSTEMS (includes conventional trim)

	1-1/2"	2"	2-1/2"	3"	4"	6"	8"
For Straight Through Valves - Vertical/Brass Trim (IPG V239)							
<u>Loose Trim</u>	<u>14768-2</u> \$10,585.23	<u>14768-2</u> \$10,585.23	<u>14769-2</u> \$10,901.97	<u>14769-2</u> \$10,901.97	<u>14770-2</u> \$11,686.28	<u>14771-2</u> \$11,627.99	<u>14772-2</u> \$11,627.05
<u>Modular Trim</u>	<u>14768-2P</u> \$11,025.02	<u>14768-2P</u> \$11,025.02	<u>14769-2P</u> \$11,297.02	<u>14769-2P</u> \$11,297.02	<u>14770-2P</u> \$12,126.04	<u>14771-2P</u> \$11,732.59	<u>14772-2P</u> P.O.A.

For Angle Style Valves - Vertical/Brass Trim (IPG V239)

<u>Loose Trim</u>	N/A	<u>14764-2</u> \$11,264.17	N/A	<u>14765-2</u> \$11,225.15	<u>14766-2</u> \$11,925.51	<u>14767-2</u> \$12,076.45	N/A
<u>Modular Trim</u>	N/A	<u>14764-2P</u> P.O.A.	N/A	<u>14765-2P</u> P.O.A.	<u>14766-2P</u> P.O.A.	<u>14767-2P</u> P.O.A.	N/A

DOMESTIC¹ BRASS TRIMS - Pressure Regulating Trim for FLOW CONTROL SYSTEMS (includes conventional trim)

	1-1/2"	2"	2-1/2"	3"	4"	6"	8"
For Straight Through Valves - Vertical/Brass Trim (IPG V239)							
<u>Loose Trim</u>	N/A	N/A	N/A	N/A	<u>14770-2USA</u> \$15,581.71	<u>14771-2USA</u> \$15,503.99	<u>14772-2USA</u> \$15,502.73

(1) Meets sourcing requirements of the Buy American Act, American Reinvestment and Recovery Act, and the Buy American Law. Contact customer service for availability.