



TABLE OF CONTENTS

Firecycle® III – Wet System	Q-1 – Q-2
Firecycle® III – Deluge System	Q-3 – Q-4
Firecycle® III – Preaction System	Q-5 – Q-6
Components and Accessories	Q-7 – Q-8
Alarm Devices	Q-9

Notes

1. Refer to Viking technical data pages for complete product specifications. You may print or download technical data by visiting www.vikinggroupinc.com.
2. List prices effective January 11, 2021. Supersedes January 2020 list price book.
3. All sales by Viking are subject to the Terms & Conditions found on the last page of this book.

Firecycle® is a registered trademark of The Viking Corporation

Firecycle® System - WET

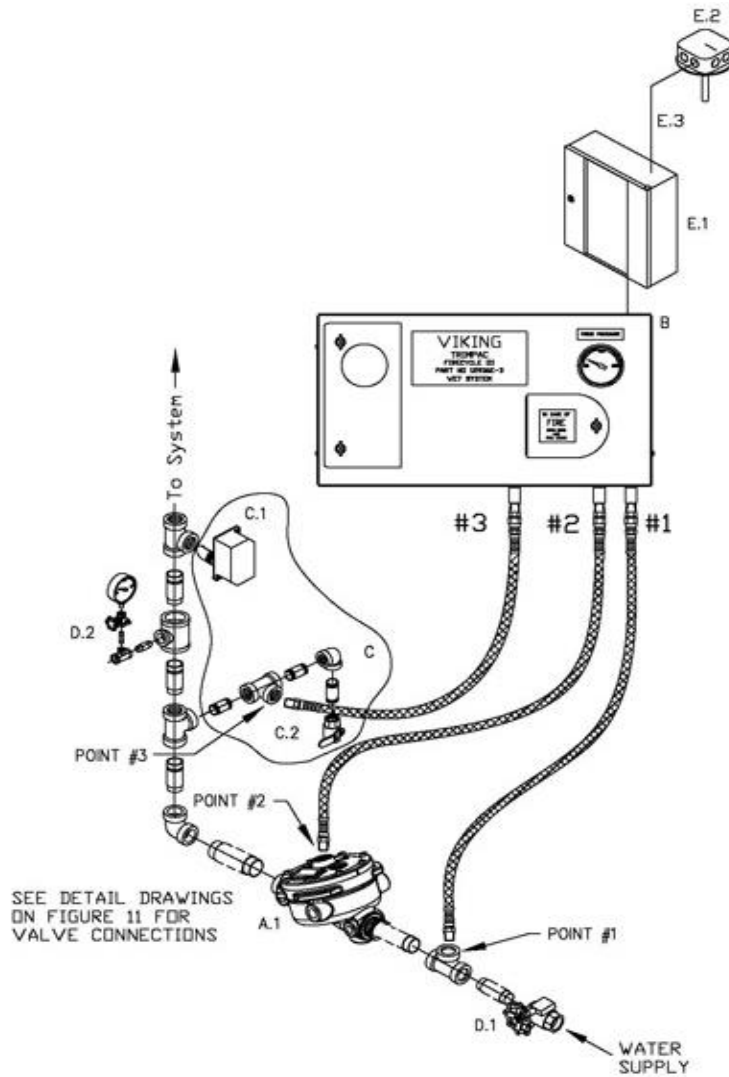

Description	
A.1	Model J flow control valve
B	TrimPac® (includes following items) Firecycle® cycling wet trim (conventional) Release trim Flexible hose kit
C	TrimPac® drain package (order separately) C.1 Water flow and alarm switch C.2 System main drain valve
D	Riser D.1 Water supply control valve D.2 System water supply gauge & valve
E	Release system E.1 Release control panel (order separately) E.2 Firecycle detector E.3 Firecycle cable

TrimPac can be used with either straight through or angle style valves (straight through shown)

Model J Flow Control Valve* - STRAIGHT THROUGH

IPG 244	1-1/2"	2"	2-1/2"	3"	4"	6"	8"
Thread X Thread	<u>12130</u> \$4,138.69	<u>12063</u> \$4,271.58	<u>12405</u> \$5,415.39	N/A	N/A	N/A	N/A
Flange X Flange	N/A	N/A	N/A	<u>12016</u> \$5,415.39	<u>11968</u> \$6,823.90	<u>11970</u> \$9,111.47	<u>11993</u> \$19,629.97
Flange X Groove	N/A	N/A	N/A	<u>12020</u> \$5,415.39	<u>11967</u> \$6,823.90	<u>11969</u> \$9,111.47	N/A
Groove X Groove	<u>12129</u> \$4,138.69	<u>12061</u> \$4,271.58	<u>12407</u> \$5,415.39	<u>12024</u> \$5,415.39	<u>11516</u> \$6,823.90	<u>11527</u> \$9,111.47	<u>11019</u> \$17,207.32

Model H Flow Control Valve* - ANGLE STYLE

IPG 244.1	1-1/2"	2"	3"	4"	6"
Thread X Thread	<u>09894</u> \$2,048.65	<u>05856C</u> \$4,686.08	N/A	N/A	N/A
Flange X Flange	N/A	N/A	<u>05914C</u> \$5,940.87	<u>05911C</u> \$7,486.04	<u>05908C</u> \$9,995.59
Flange X Groove	N/A	N/A	<u>05837C</u> \$5,940.87	<u>05841C</u> \$7,486.04	<u>05458C</u> \$9,995.59

See page P-7 for Halar® coated valves

* Valve is not included in trim packages. Please order separately. See following page for trim packages and equipment.

Firecycle® System - WET

Viking's Firecycle® systems are available in TrimPac arrangement only. Loose or modular trim not offered.

TrimPac® (IPG V234)

GALVANIZED Trim	1-1/2"	2"	2-1/2"	3"	4"	6"	8"
Cycling Wet System	<u>12936E-3</u>	<u>12936E-3</u>	<u>12936E-3</u>	<u>12936E-3</u>	<u>12936E-3</u>	<u>12936E-3</u>	<u>12936E-3</u>
	\$7,390.96	\$7,390.96	\$7,390.96	\$7,390.96	\$7,390.96	\$7,390.96	\$7,390.96
BRASS Trim	1-1/2"	2"	2-1/2"	3"	4"	6"	8"
Cycling Wet System	<u>12936E-3B</u>	<u>12936E-3B</u>	<u>12936E-3B</u>	<u>12936E-3B</u>	<u>12936E-3B</u>	<u>12936E-3B</u>	<u>12936E-3B</u>
	\$10,384.21	\$10,384.21	\$10,384.21	\$10,384.21	\$10,384.21	\$10,384.21	\$10,384.21

TrimPac includes conventional trim, (1) NO solenoid valve, (1) NC solenoid valve, releasing trim, and flexible hose kit.
Drain package for TrimPac must be ordered separately (see below).



Drain Package

IPG V257	1-1/2"	2"	2-1/2"	3"	4"	6"	8"
Use with TrimPac®	<u>11894-1</u>	<u>11894-2</u>	<u>11894-3</u>	<u>11894-3</u>	<u>11894-4</u>	<u>11894-4</u>	<u>11894-4</u>
(order separately)	\$575.79	\$465.73	\$527.79	\$527.79	\$677.39	\$677.39	\$677.39

Accessories for TrimPac® (IPG V234)

Air Line Trim	Replacement Hose		Riser Mounting Kit	
(not for use with Deluge TrimPac System)	PVC drain hose 12071 \$156.35		(when mounting TrimPac to riser)	
<u>Tank Mounted</u> 13770 \$1,963.12			<u>Vertical</u> 11900 \$1,085.75	
<u>Tankless</u> 13771 \$692.15			<u>Horizontal</u> 11901 \$1,492.97	

Firecycle® Detectors*

Firecycle III-OH Detectors				Firecycle II and III Detectors			
IPG V248				IPG V248			
<u>Flush Mount</u>				<u>Use with cable in conduit</u>			
	11723	140°F / 60°C	\$739.94		08288	140°F / 60°C	\$1,831.63
	11724	160°F / 71°C	\$739.94		08289	160°F / 71°C	\$1,831.63
	11725	190°F / 88°C	\$739.94		08290	190°F / 88°C	\$1,831.63
	11726	225°F / 107°C	\$739.94				
<u>Surface Mount</u>							
	11727	140°F / 60°C	\$739.94				
	11728	160°F / 71°C	\$739.94				
	11729	190°F / 88°C	\$739.94				
	11730	225°F / 107°C	\$739.94				

Firecycle detectors can be installed in finished ceilings using recessed escutcheon. See technical data for details.

CABLE - Firecycle® III and III-OH IPG V248

(for use in conduit)							
18 Gauge FPL	19750	\$12.19	per ft	(100 ft minimum order)			
16 Gauge FPL	19749	\$17.41	per ft	(100 ft minimum order)			

* See pages Q-7 - Q-9 for additional accessories and related components

Firecycle® System - DELUGE

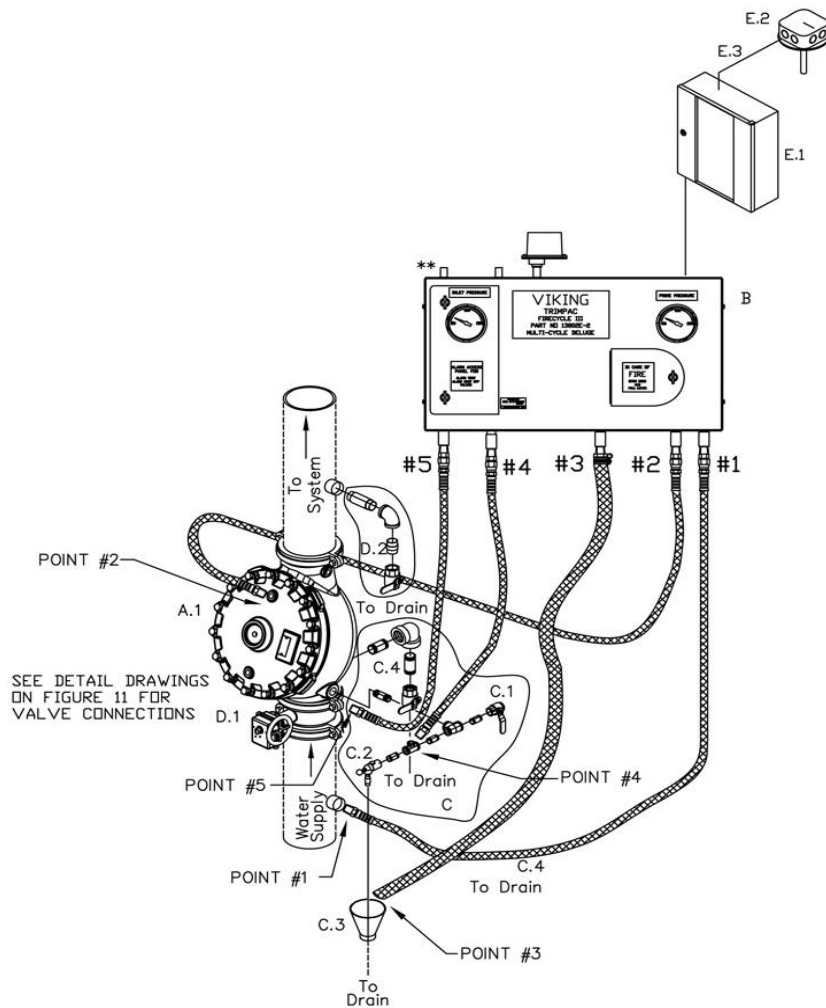

Description	
A.1	Model J flow control valve
B	TrimPac® (includes following items) Firecycle® deluge trim (conventional) Release trim Flexible hose kit
C	TrimPac® drain package (order separately)
C.1	Auxiliary drain valve (normally closed)
C.2	Drip check valve
C.3	Drain cup
C.4	Flow test valve (normally closed)
D	Riser
D.1	Water supply control valve
D.2	System main drain
E	Release system
E.1	Release control panel (order separately)
E.2	Firecycle detector
E.3	Detector cables

TrimPac can be used with either straight through or angle style valves (straight through shown).

Model J Flow Control Valve* - STRAIGHT THROUGH

IPG 244	1-1/2"	2"	2-1/2"	3"	4"	6"	8"
Thread X Thread	<u>12130</u> \$4,138.69	<u>12063</u> \$4,271.58	<u>12405</u> \$5,415.39	N/A	N/A	N/A	N/A
Flange X Flange	N/A	N/A	N/A	<u>12016</u> \$5,415.39	<u>11968</u> \$6,823.90	<u>11970</u> \$9,111.47	<u>11993</u> \$19,629.97
Flange X Groove	N/A	N/A	N/A	<u>12020</u> \$5,415.39	<u>11967</u> \$6,823.90	<u>11969</u> \$9,111.47	N/A
Groove X Groove	<u>12129</u> \$4,138.69	<u>12061</u> \$4,271.58	<u>12407</u> \$5,415.39	<u>12024</u> \$5,415.39	<u>11516</u> \$6,823.90	<u>11527</u> \$9,111.47	<u>11019</u> \$17,207.32

Model H Flow Control Valve* - ANGLE STYLE

IPG 244.1	1-1/2"	2"	3"	4"	6"
Thread X Thread	<u>09894</u> \$2,048.65	<u>05856C</u> \$4,686.08	N/A	N/A	N/A
Flange X Flange	N/A	N/A	<u>05914C</u> \$5,940.87	<u>05911C</u> \$7,486.04	<u>05908C</u> \$9,995.59
Flange X Groove	N/A	N/A	<u>05837C</u> \$5,940.87	<u>05841C</u> \$7,486.04	<u>05458C</u> \$9,995.59

See page P-7 for Halar® coated valves

* Valve is not included in trim packages. Please order separately. See following page for trim packages and equipment.

Firecycle® System - DELUGE

Viking's Firecycle® systems are available in TrimPac arrangement only. Loose or modular trim not offered.

TrimPac® (IPG V234)

GALVANIZED Trim	1-1/2"	2"	2-1/2"	3"	4"	6"	8"
Multicycle Deluge <i>(includes release & trim)</i>	<u>13802E-2</u> \$7,390.96	<u>13802E-2</u> \$7,390.96	<u>13802E-2</u> \$7,390.96	<u>13802E-2</u> \$7,390.96	<u>13802E-2</u> \$7,390.96	<u>13802E-2</u> \$7,390.96	<u>13802E-2</u> \$7,390.96
BRASS Trim	1-1/2"	2"	2-1/2"	3"	4"	6"	8"
Multicycle Deluge <i>(includes release & trim)</i>	<u>13802E-2B</u> \$10,384.21	<u>13802E-2B</u> \$10,384.21	<u>13802E-2B</u> \$10,384.21	<u>13802E-2B</u> \$10,384.21	<u>13802E-2B</u> \$10,384.21	<u>13802E-2B</u> \$10,384.21	<u>13802E-2B</u> \$10,384.21

TrimPac® includes conventional trim, (1) NO solenoid valve, (1) NC solenoid valve, releasing trim, and flexible hose kit.
Drain package for TrimPac must be ordered separately (see below).



Drain Package

IPG V257	1-1/2"	2"	2-1/2"	3"	4"	6"	8"
Use with TrimPac® <i>(order separately)</i>	<u>11894-1</u> \$575.79	<u>11894-2</u> \$465.73	<u>11894-3</u> \$527.79	<u>11894-3</u> \$527.79	<u>11894-4</u> \$677.39	<u>11894-4</u> \$677.39	<u>11894-4</u> \$677.39

Accessories for TrimPac® (IPG V234)

Air Line Trim <i>(not for use with Deluge TrimPac System)</i>	Replacement Hose			Riser Mounting Kit <i>(when mounting TrimPac to riser)</i>		
<u>Tank Mounted</u> 13770 \$1,963.12	<u>PVC drain hose</u>	12071	\$156.35	<u>Vertical</u>	11900	\$1,085.75
<u>Tankless</u> 13771 \$692.15				<u>Horizontal</u>	11901	\$1,492.97

Firecycle® Detectors*

Firecycle III-OH Detectors IPG V248				Firecycle II and III Detectors IPG V248			
<u>Flush Mount</u>				<u>Use with cable in conduit</u>			
	11723	140°F / 60°C	\$739.94		08288	140°F / 60°C	\$1,831.63
	11724	160°F / 71°C	\$739.94		08289	160°F / 71°C	\$1,831.63
	11725	190°F / 88°C	\$739.94		08290	190°F / 88°C	\$1,831.63
	11726	225°F / 107°C	\$739.94				
<u>Surface Mount</u>							
	11727	140°F / 60°C	\$739.94				
	11728	160°F / 71°C	\$739.94				
	11729	190°F / 88°C	\$739.94				
	11730	225°F / 107°C	\$739.94				

Firecycle detectors can be installed in finished ceilings using recessed escutcheon. See technical data for details.

CABLE - Firecycle® III and III-OH IPG V248

<i>(for use in conduit)</i>			
18 Gauge FPL	19750	\$12.19	per ft (100 ft minimum order)
16 Gauge FPL	19749	\$17.41	per ft (100 ft minimum order)

* See pages Q-7 - Q-9 for additional accessories and related components

Firecycle® System - PREACTION - Single/Double Interlocked

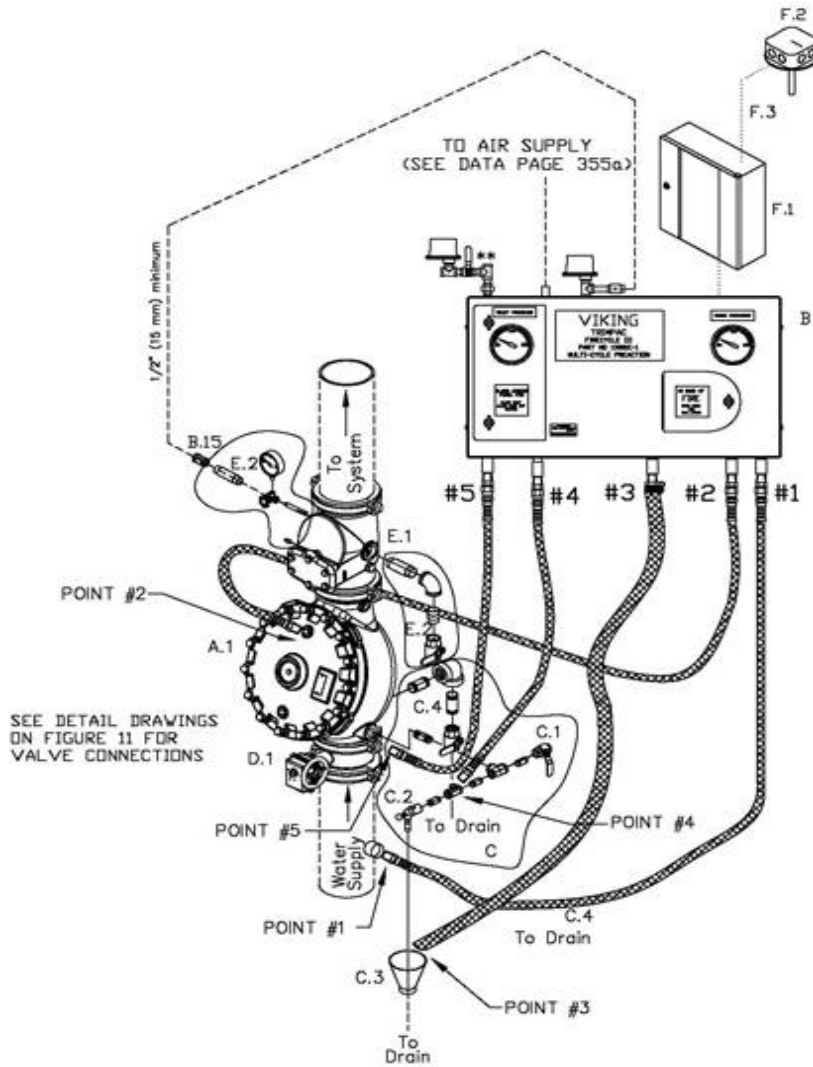

Description	
A.1	Model J flow control valve
B	TrimPac® (includes following items) Firecycle® preaction trim (conventional) Release trim Flexible hose kit
C	TrimPac® drain package (order separately)
C.1	Auxiliary drain valve (normally closed)
C.2	Drip check valve
C.3	Drain cup
C.4	Flow test valve (normally closed)
D	Riser
D.1	Water supply control valve
E	Check valve (order separately)
E.1	Easy Riser® check valve
E.2	Check valve trim (order separately)
E	Release system
E.1	Release control panel (order separately)
E.2	Firecycle detector
E.3	Firecycle cable

TrimPac can be used with either straight through or angle style valves (straight through shown).

Model J Flow Control Valve* - STRAIGHT THROUGH

IPG 244	1-1/2"	2"	2-1/2"	3"	4"	6"	8"
Thread X	<u>12130</u>	<u>12063</u>	<u>12405</u>	N/A	N/A	N/A	N/A
Thread	\$4,138.69	\$4,271.58	\$5,415.39				
Flange X	N/A	N/A	N/A	<u>12016</u>	<u>11968</u>	<u>11970</u>	<u>11993</u>
Flange				\$5,415.39	\$6,823.90	\$9,111.47	\$19,629.97
Flange X	N/A	N/A	N/A	<u>12020</u>	<u>11967</u>	<u>11969</u>	N/A
Groove				\$5,415.39	\$6,823.90	\$9,111.47	
Groove X	<u>12129</u>	<u>12061</u>	<u>12407</u>	<u>12024</u>	<u>11516</u>	<u>11527</u>	<u>11019</u>
Groove	\$4,138.69	\$4,271.58	\$5,415.39	\$5,415.39	\$6,823.90	\$9,111.47	\$17,207.32

Model H Flow Control Valve* - ANGLE STYLE

IPG 244.1	1-1/2"	2"	3"	4"	6"
Thread X	<u>09894</u>	<u>05856C</u>	N/A	N/A	N/A
Thread	\$2,048.65	\$4,686.08			
Flange X	N/A	N/A	<u>05914C</u>	<u>05911C</u>	<u>05908C</u>
Flange			\$5,940.87	\$7,486.04	\$9,995.59
Flange X	N/A	N/A	<u>05837C</u>	<u>05841C</u>	<u>05458C</u>
Groove			\$5,940.87	\$7,486.04	\$9,995.59

See page P-7 for Halar® coated valves

* Valve is not included in trim packages. Please order separately. See following page for trim packages and equipment.

Firecycle® System - PREACTION - Single/Double Interlocked

Viking's Firecycle® systems are available in TrimPac arrangement only. Loose or modular trim not offered.

TrimPac® (IPG V234)

	1-1/2"	2"	2-1/2"	3"	4"	6"	8"
GALVANIZED Trim							
Single/Double Interlock <i>(includes release & trim)</i>	<u>13801E-1</u> \$7,390.96	<u>13801E-1</u> \$7,390.96	<u>13801E-1</u> \$7,390.96	<u>13801E-1</u> \$7,390.96	<u>13801E-1</u> \$7,390.96	<u>13801E-1</u> \$7,390.96	<u>13801E-1</u> \$7,390.96
BRASS Trim							
Single/Double Interlock <i>(includes release & trim)</i>	<u>13801E-1B</u> \$10,384.21	<u>13801E-1B</u> \$10,384.21	<u>13801E-1B</u> \$10,384.21	<u>13801E-1B</u> \$10,384.21	<u>13801E-1B</u> \$10,384.21	<u>13801E-1B</u> \$10,384.21	<u>13801E-1B</u> \$10,384.21

Trim Pac includes conventional trim, (1)NO solenoid valve, (1)NC solenoid valve, pneumatic actuator, releasing trim, and flexible hose kit. Drain package ordered separately (see below).

Drain Package (IPG V257)

Use with TrimPac® <i>(order separately)</i>	11894-1 \$575.79	11894-2 \$465.73	11894-3 \$527.79	11894-3 \$527.79	11894-4 \$677.39	11894-4 \$677.39	11894-4 \$677.39
--	---------------------	---------------------	---------------------	---------------------	---------------------	---------------------	---------------------

1-1/2"	2"	2-1/2"	3"	4"	6"	8"
--------	----	--------	----	----	----	----

Riser Check Valve and Trim (IPG V259 / V222)



Riser Check Valve Threaded	<u>10659</u> \$749.75	<u>10667</u> \$866.85	N/A	N/A	N/A	N/A	N/A
Riser Check Valve Flange / Flange	N/A	N/A	N/A	<u>08505</u> \$1,245.58	<u>08508</u> \$1,283.41	<u>08511</u> \$2,116.11	N/A
Riser Check Valve Flange / Groove	N/A	N/A	N/A	<u>08506</u> \$1,056.39	<u>08509</u> \$1,087.34	<u>08512</u> \$1,799.52	<u>08515</u> \$2,547.06
Riser Check Valve Groove / Groove	<u>11054</u> \$749.75	<u>11059</u> \$866.85	<u>07929</u> \$898.06	<u>08507</u> \$898.06	<u>08510</u> \$898.06	<u>08513</u> \$1,661.93	<u>08516</u> \$2,353.53
Riser Check Valve Trim <i>(For Preaction)</i>	<u>12960</u> \$248.83	<u>12960</u> \$248.83	<u>13776</u> \$623.37	<u>13776</u> \$623.37	<u>13777</u> \$658.95	<u>13777</u> \$658.95	<u>13777</u> \$658.95
Riser Check Valve Trim BRASS	<u>12960-1</u> \$420.72	<u>12960-1</u> \$420.72	N/A	N/A	N/A	N/A	N/A

* Riser check valve trim includes system main drain valve and air pressure gauge.

Accessories for TrimPac® (IPG V234)



Air Line Trim <i>(not for use with Deluge TrimPac System)</i>		Replacement Hose PVC drain hose		Riser Mounting Kit <i>(when mounting TrimPac to riser)</i>	
<u>Tank Mounted</u>	13770 \$1,963.12	12071	\$156.35	<u>Vertical</u>	11900 \$1,085.75
<u>Tankless</u>	13771 \$692.15			<u>Horizontal</u>	11901 \$1,492.97

Firecycle® Detectors*

Firecycle III-OH Detectors				Firecycle II and III Detectors			
IPG V248				IPG V248			
<u>Flush Mount</u>				<u>Use with cable in conduit</u>			
	11723	140°F / 60°C	\$739.94		08288	140°F / 60°C	\$1,831.63
	11724	160°F / 71°C	\$739.94		08289	160°F / 71°C	\$1,831.63
	11725	190°F / 88°C	\$739.94		08290	190°F / 88°C	\$1,831.63
	11726	225°F / 107°C	\$739.94				
<u>Surface Mount</u>							
	11727	140°F / 60°C	\$739.94				
	11728	160°F / 71°C	\$739.94				
	11729	190°F / 88°C	\$739.94				
	11730	225°F / 107°C	\$739.94				

Firecycle detectors can be installed in finished ceilings using recessed escutcheon. See technical data for details.

Accessories for Firecycle® Systems

Firecycle® Detectors*				
Firecycle III-OH Detectors		IPG V248	Firecycle II and III Detectors	IPG V248
<u>Flush Mount</u>				
11723	140°F / 60°C	\$739.94		<u>Use with cable in conduit</u>
11724	160°F / 71°C	\$739.94		08288 140°F / 60°C \$1,831.63
11725	190°F / 88°C	\$739.94		08289 160°F / 71°C \$1,831.63
11726	225°F / 107°C	\$739.94		08290 190°F / 88°C \$1,831.63
<u>Surface Mount</u>				
	11727	140°F / 60°C	\$739.94	
	11728	160°F / 71°C	\$739.94	
	11729	190°F / 88°C	\$739.94	
	11730	225°F / 107°C	\$739.94	



(1) Includes mounting nuts and ceramic wire nuts

Firecycle detectors can be installed in finished ceilings using recessed escutcheon. See technical data for details.

RELEASE CONTROL PANEL (VFR-400)		IPG V241			
VFR-400 Release Control Panel					
<ul style="list-style-type: none"> - Multi-hazard operation - Features on board, menu driven programming - Four Class B initiating circuits - Two Class B supervisory circuits** - Four Class B output circuits - Programmable cross zoning - 12 standard programs (program options for Viking preaction, deluge, Surefire® and Firecycle® systems) 	 <table border="1"> <thead> <tr> <th>Part No.</th> <th>List Price</th> </tr> </thead> <tbody> <tr> <td>14152-1</td> <td>\$4,368.39</td> </tr> </tbody> </table> <p>* see below for accessories and optional modules</p>	Part No.	List Price	14152-1	\$4,368.39
Part No.	List Price				
14152-1	\$4,368.39				
Optional Modules / Accessories					
CA2Z Module (class A initiating device circuit):	14155	\$260.80			
CAM2 Module (class A indicating appliance circuit):	14156	\$299.92			
ARM-1/ARM-2 Module (auxiliary relay module):	14157	\$378.16			
RA-4410-RC (remote annunciator):	14154	\$1,369.18			
	Part No.	List Price			
MR-101/T SPDT Relay Module:	14159	\$153.24			
MR-201 DPDT Relay Module:	14160	\$192.33			
MR801/T SPDT Relay w/Led Indicator:	14161	\$81.50			
ELOD Resistor/Diode:	14162	\$39.12			
ELOR Resistor:	14163	\$3.27			
	Batteries	(two required per panel)			
	Part No.	List Price			
	8 Amp	07920 \$95.43			
	12 Amp	07921 P.O.A.			
	18 Amp	09867 P.O.A.			
	Battery Cabinet (for 18 amp hr battery)				
	Part No.	List Price			
	09866	\$763.36			

CABLE - Firecycle® III and III-OH				IPG V248
(for use in conduit)				
18 Gauge FPL	19750	\$12.19	per ft	(100 ft minimum order)
16 Gauge FPL	19749	\$17.41	per ft	(100 ft minimum order)

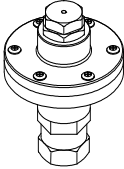
Accessories for Firecycle® Systems

<u>Model D-2 - Air Pressure Maintenance Device</u>				<u>Model D-2 - Air Pressure Maintenance Device</u>			
	<u>Size</u>	<u>Part #</u>	<u>List Price</u>		<u>Size</u>	<u>Part #</u>	<u>List Price</u>
	1/4" / DN8	02280C	\$798.29		1/2" / DN15	07459	\$1,402.81
V226				V226			
<u>Dehydrator Package</u>				<u>Filter Kit</u>			
Includes:				V249		03007A	\$49.80
- Desiccant	1/4" (DN8)						
- Mounting Brackets		16854	\$1,888.79				
- Nipples	<u>Extra Desiccant*</u>						
		16855	\$427.65				
IPG V226	*one unit fills dehydrator						



<u>Electric Bell</u>			
	<u>120V AC</u>		
	8" / 200 mm	PBA-1208	\$115.97
IPG SR030			

Accessories for TrimPac® (IPG V234)

<u>Air Line Trim</u>			<u>Replacement Hose</u>			<u>Riser Mounting Kit</u>		
<i>(not for use with Deluge TrimPac System)</i>			PVC drain hose			<i>(when mounting TrimPac to riser)</i>		
<u>Tank Mounted</u>	13770	\$1,963.12	12071	\$156.35	<u>Vertical</u>	11900	\$1,085.75	
<u>Tankless</u>	13771	\$692.15			<u>Horizontal</u>	11901	\$1,492.97	

Alarm Devices

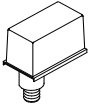
Alarm Pressure Switch - SR020

<u>Adjustable Range (4-20 psi)</u>			<u>Explosion Proof</u>		
<u>1/2" / DN50</u>			Dual SPDT	PS10-EX	\$1,460.47
Single SPDT	PS101A	\$232.62	Dual SPDT	PS40EX	\$1,469.48
Dual SPDT	PS102A	\$279.87	* Cenelec approved		
* Manufactured by Potter			<u>Pressure Adj Access Key</u>		
				10600	\$29.97
			<u>Cover Removal Key</u>		
			10601 \$29.97		

* Appropriate hex keys included with switches.

Pressure Supervisory Switch (Air, Nitrogen, Water) - IPG SR020

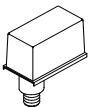

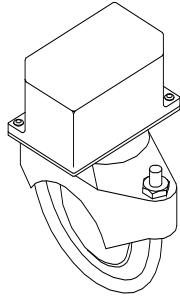

<u>Adjustable Range (10-175 psi)</u>			<u>Explosion Proof</u>		
<u>1/2" / DN50</u>			Dual SPDT	10379	\$1,974.34
Single SPDT	PS401A	\$232.62	* Cenelec approved		
Dual SPDT	PS402A	\$279.81	<u>Pressure Adj Access Key</u>		
* Manufactured by Potter				10600	\$29.97
			<u>Cover Removal Key</u>		
<u>Cover Tamper Switch Kit</u>			10601 \$29.97		
09601 \$153.25					

* Appropriate hex keys included with switches.

Flow Switch - SR010

<u>Waterflow Indicators</u>			
(adjustable retard up to 120 sec. - 2 SPDT contacts)			
<u>Model VSR</u>			
1-2" / DN40	VSRF0100	\$332.34	
2" / DN50	VSRF0200	\$360.22	
2½" / DN65	VSRF0250	\$360.22	
3" / DN80	VSRF0300	\$360.22	
3½" / DN90	VSRF0350	\$360.22	
4" / DN100	VSRF0400	\$360.22	
5" / DN125	VSRF0500	\$360.22	
6" / DN150	VSRF0600	\$360.22	
8" / DN200	VSRF0800	\$403.10	

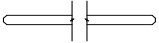
Water Motor Alarm and Accessories - IPG V226

<u>Water Motor Alarm</u>		<u>Closure Plate</u>	
	<u>Model F-2</u> 07862 \$681.01		05820B \$138.99
<u>Adjustable Shaft</u>		<u>Alarm Line Y Strainer</u>	
(wall thickness up to 30-1/4 in / 768 mm)			<u>3/4" (DN20)</u> 01489A \$202.79
	03312B \$133.36		
<u>Extension Cup</u>			
	05957B \$111.20		