



Section R
Foam Systems

TABLE OF CONTENTS

Foam Systems	R-1 – R-3
Concentrate Control Valves and Trim.....	R-4
Valve Trim for Premixed Foam Systems.....	R-4
Release Trim Packages	R-4
Foam Concentrates	R-5
Accessories, Foam Concentrates	R-5 – R-6
Proportioning Devices.....	R-7 – R-8
Discharge Devices.....	R-9 – R-11
Bladder Tanks	R-12
Double Wall (SAFE) Atmospheric Storage Tanks	R-13
Single Wall Atmospheric Storage Tanks	R-14
Atmospheric Storage Tank Optional Equipment	R-15
FoamPak Foam Pump Skid, 60 Hz, Single and Dual.....	R-16
FoamPak Foam Pump Skid, 50 Hz, Single and Dual.....	R-17
FoamPak Accessories	R-18
High Expansion Foam Systems	R-19

Notes

1. Refer to Viking technical data pages for complete product specifications. You may print or download technical data by visiting www.vikinggroupinc.com.
2. List prices effective May 31, 2021. Supersedes January 2021 list price book.
3. All sales by Viking are subject to the Terms & Conditions found on the last page of this book.



FOAM SYSTEMS

Wet-Pipe Foam/Water System supplied by a Bladder Tank

A Wet Pipe Foam/Water System Supplied by Bladder Tank with a hydraulically actuated Viking Halar® deluge concentrate control valve (CCV) consists of a standard wet pipe sprinkler system using a Viking alarm check valve complete with trim, retard chamber, ratio controller proportioning device with appropriately sized orifice, hydraulically actuated Viking Halar® Deluge Valve, foam concentrate bladder tank and foam agent.

<http://www.vikinggroupinc.com/sites/default/files/documents/031916.pdf>

Wet-Pipe Foam/Water System supplied by a Foam Pump

A Wet Pipe Foam/Water System Supplied by Foam Pump with a hydraulically actuated Viking Halar® deluge concentrate control valve (CCV) consists of a standard wet pipe sprinkler system using a Viking alarm check valve complete with trim, an In-Line Balanced Proportioner (ILBP) which includes a concentrate controller, listed orifice plate, spool balancing valve, and swing check valve, a hydraulically actuated Viking Halar® Deluge Valve, a foam concentrate bladder tank and foam concentrate, a CCV priming connection, a foam concentrate atmospheric tank/trim and foam agent.

<http://www.vikinggroupinc.com/sites/default/files/databook/foam/design/011501.pdf>

Wet-Pipe Foam/Water Multiple Systems supplied by a Bladder Tank

Multiple wet foam risers are supplied by a single bladder tank by a piping manifold installed from the discharge head of the bladder tank to each individual riser. The foam manifold will be sized for the most severe volume requirement and metered pressure drop requirement. At each riser location, a supply outlet will be provided from the concentrate manifold supply. The supply outlet will have a concentrate shut-off valve, Halar® coated concentrate control valve, concentrate piping, a concentrate swing check valve, and a concentrate controller with integral metering orifice. The individual sprinkler riser will have a water supply control valve, Viking alarm check valve with trim and retard chamber, sprinkler riser piping, concentrate controller, solution test valve, and system isolation valve.

<http://www.vikinggroupinc.com/sites/default/files/databook/foam/design/011901.pdf>

Wet-Pipe Foam/Water Manifold Systems supplied by a Foam Pump

With a Wet Pipe Foam/Water Manifold System Supplied by Foam Pump, multiple risers can be supplied from a single proportioning device. A riser manifold is installed with various riser types and sizes that are to supply foam solution to their hazard areas. A proportioning device is located upstream of the riser manifold. Foam solution is supplied to any or all risers where a water flow is present. If the desire is install a completely mechanical proportioning system, an alarm check valve will be required upstream of the proportioning device. A foam pump can supply foam concentrate to an individual In-line Balanced Proportioning Assembly (ILBP) serving multiple risers in a manifold. A single proportioning device supplying multiple risers can be an economical method of providing foam risers.

<http://www.vikinggroupinc.com/sites/default/files/databook/foam/design/011801.pdf>

Wet-Pipe Low Flow Foam/Water System supplied by a Bladder Tank

The Viking Low Flow Foam/Water proportioning system is a UL Listed and FM Approved system, for use with Viking supplied foam concentrates. This system consists of a standard wet pipe sprinkler system, using a Viking alarm check valve, complete with trim and retard chamber, a factory assembled and tested Viking pilot operated pressure control valve, an in-line balanced pressure foam concentrate proportioning assembly (ILBP), bladder tank with trim, a hydraulic actuated Viking Halar® coated concentrate control deluge valve and foam concentrate UL Listed and FM Approved for use with the Viking system. This system was developed to provide an accurate foam/water solution at much lower flow ranges than what a conventional concentrate controller is capable of. The low flow foam system will also provide positive foam injection throughout the full range of system flows. It will provide a rich foam solution at low flows below the listed and approved minimum flow rates, which makes it ideal for use on closed head wet pipe sprinkler systems. Therefore, it is now possible to obtain the desired concentrate percentage at lower flows, which results in the operation of fewer sprinklers on the wet pipe systems, to achieve the desired foam/water solution percentage.

<http://www.vikinggroupinc.com/sites/default/files/documents/031816.pdf>

Wet-Pipe Low Flow Foam/Water Manifold System supplied by a Bladder Tank

With the Wet Pipe Low Flow Foam/Water Manifold System, multiple risers can be supplied from a single proportioning device. A riser manifold is installed with various riser types and sizes that are to supply foam solution to their hazard areas. A proportioning device is located upstream of the riser manifold. Foam solution is supplied to any or all risers where a water flow is present. If the desire is to install a completely mechanical proportioning system, an alarm check valve will be required upstream of the proportioning device. A Viking Low Flow Foam system utilizing a bladder tank can supply foam concentrate to an individual in-line balanced proportioning assembly (ILBP) serving multiple risers in a manifold. A single proportioning device supplying multiple risers can be an economical method of providing foam risers.

<http://www.vikinggroupinc.com/sites/default/files/databook/foam/design/011701.pdf>

Deluge Foam/Water System supplied by a Bladder Tank

A Deluge Foam/Water System Supplied by Bladder Tank is a standard deluge system capable of discharging a foam/water solution automatically through open sprinklers, spray nozzles, monitor nozzles, and other discharge devices. A Deluge Foam/Water System Supplied by Bladder Tank with a hydraulically actuated Viking Halar® coated deluge CCV consists of a standard deluge system using a Viking deluge valve complete with full standard trim and detection and releasing devices, a concentrate controller-proportioning device with appropriately sized orifice, a hydraulically actuated Viking Halar® coated deluge CCV on foam concentrate line, a foam concentrate bladder tank, and trim and foam agent.

<http://www.vikinggroupinc.com/sites/default/files/documents/031716.pdf>

Deluge Foam/Water System supplied by a Foam Pump

A Foam Deluge System Supplied by a Foam Pump is a standard deluge system capable of discharging foam/water solution automatically through any discharge device supplied from the deluge system piping. A deluge foam/water system with a hydraulically actuated Halar® coated concentrate control valve consists of a Viking deluge valve complete with standard deluge trim, detection and releasing devices on the water supply line, an In-line Balanced Proportioner Assembly (proportioning device), which includes a concentrate controller, listed orifice plate, spool balancing valve and swing check valve, hydraulically actuated Halar® coated concentrate control valve on foam concentrate line, a foam concentrate atmospheric tank and trim, and foam concentrate agent.

<http://www.vikinggroupinc.com/sites/default/files/databook/foam/design/011301.pdf>

Deluge Foam/Water Multiple Systems supplied by a Bladder Tank

With Multiple Foam/Water Deluge Systems Supplied by a Bladder Tank, multiple deluge foam risers can be supplied from a single foam concentrate source. Where a bladder tank is used as the foam concentrate storage container and foam concentrate source, a manifold foam concentrate supply from the bladder tank to the individual risers is a cost effective method of installing many foam risers without duplicating the foam concentrate supply for each different riser. The foam concentrate bladder tank will be sized by the most demanding system. It is important to remember that the most demanding system will also require taking in account that the duration requirement per system may differ as well. At each riser location, a supply outlet will be provided from the concentrate manifold supply. The supply outlet will have a concentrate shut-off valve, Halar® coated concentrate control valve, concentrate piping, a concentrate swing check valve, and a concentrate controller with integral metering orifice. The individual deluge riser will have a water supply control valve, Viking deluge valve with deluge trim, riser piping, concentrate controller, solution test valve and system isolation valve.

<http://www.vikinggroupinc.com/sites/default/files/databook/foam/design/011601.pdf>

Preaction Foam/Water System supplied by a Bladder Tank

A Preaction Foam/Water System Supplied by a Bladder Tank is a standard preaction system capable of discharging a foam/water solution automatically through any sprinklers that operate. A Preaction Foam/Water System Supplied by Bladder Tank with a hydraulically actuated Halar® Coated Deluge Concentrate Control Valve consists of a standard preaction system using a Viking deluge valve complete with full standard preaction trim, detection, and releasing devices on the water supply line, a ratio controller-proportioning device with appropriately sized orifice, a hydraulically actuated Viking Halar® coated deluge CCV on foam concentrate line, a foam concentrate bladder tank and foam concentrate.

<http://www.vikinggroupinc.com/sites/default/files/documents/032016.pdf>

Preaction Foam/Water System supplied by a Foam Pump

A Preaction Foam/Water System Supplied by a Foam Pump is a standard preaction system capable of discharging foam/water solution automatically through any discharge device supplied from the preaction system piping. A preaction foam/water system with a hydraulically actuated Halar® coated concentrate control valve consists of the following: a Viking deluge valve complete with standard deluge trim, riser check valve, supervisory air supply, detection and releasing devices on the water supply line, an In-line Balanced Proportioner Assembly (proportioning device), which includes a concentrate controller, listed orifice plate, spool balancing valve and swing check valve, hydraulically actuated Halar® coated concentrate control valve on foam concentrate line, a foam concentrate atmospheric tank and trim and foam concentrate agent.

<http://www.vikinggroupinc.com/sites/default/files/databook/foam/design/011401.pdf>

Preaction Low Flow Foam/Water System supplied by a Bladder Tank

The Viking Preaction Low-Flow Foam/Water System is a UL Listed and FM Approved system, for use with Viking-supplied foam concentrate. This sprinkler system consists of the following: A standard single-interlocked preaction sprinkler system, using a Viking flow control valve with pressure regulating deluge and flow control trim, Viking Easy Riser® Check Valve, release module for the supplemental detection system, an in-line balanced-pressure foam concentrate proportioning assembly (ILBP), hydraulically actuated Viking Halar® coated concentrate control valve, and foam concentrate that is UL Listed and FM Approved for use with the Viking system. This system was developed to provide an accurate foam/water solution at much lower flow ranges than a conventional concentrate controller. The low-flow foam system will also provide positive foam injection throughout the full range of system flows. The Viking preaction low-flow foam system also allows for the use of multiple foam discharge points with. It is capable of sizing the proportioner specifically for the area of application, while using only a single source of foam concentrate supply. Water supply pressure to the bladder tank must be provided from an upstream source, preceding the pilot regulating control valve and preferably near a main fire water source, pump, or centrally located bladder tank. The inlet foam concentrate pressure to balancing valve must be 15-20 psig (1.03-1.38 BAR) higher for the Viking ILBP assembly than the water inlet pressure to the concentrate controller (CC) at each proportioner location. The balancing valve senses inlet water pressure and balances the foam concentrate pressure to match water pressure at inlet of foam concentrate to metering orifice of (CC).

<http://www.vikinggroupinc.com/sites/default/files/databook/foam/design/091698.pdf>

Pilot Regulating Foam/Water Deluge System supplied by a Bladder Tank

The Pilot Pressure Regulating Foam/Water Deluge System Supplied by a Bladder Tank is a UL Listed and FM Approved system, for use with Viking supplied foam concentrate. This sprinkler system consists of a standard deluge sprinkler system, using a Viking flow control valve with pressure regulating flow control trim, a release module for the supplemental detection system, an In-Line Balanced Pressure Proportioner ILBP, a hydraulically actuated Viking Halar® coated concentrate control valve, and foam concentrate UL listed and FM approved for use with the Viking system. Water supply pressure to the bladder tank must be provided from a downstream source, after the pilot pressure regulating deluge valve, preferably between the discharge outlet of the flow control valve and the ILBP. The listed pressure differential for the pressure regulating trim is 20 PSIG (1.38 bar). This means that the inlet pressure at the desired flow rate to the pressure regulating deluge system has to be 20 psi higher than the desired pressure on the discharge side of the deluge valve. In order to obtain the pressure differential between foam/water solution and supply water pressure, the pilot pressure regulating valve on the pressure regulating deluge trim must be adjusted to reduce the water pressure past the discharge side of the flow control valve. For best results, the pilot pressure regulating deluge valve should be set using the downstream pressure gauge of the pilot pressure regulating deluge valve and the water pressure gauge.

<http://www.vikinggroupinc.com/sites/default/files/databook/foam/design/101798.pdf>

Pilot Regulating Foam/Water Multiple Deluge Systems supplied by a Bladder Tank

Multiple pilot pressure regulating foam risers can be supplied by a single bladder tank when a concentrate manifold from the discharge head of the bladder tank is installed to each individual riser. The foam concentrate manifold will be sized for the most severe volume requirement and metered pressure drop requirement. At each riser location, a supply outlet will be provided from the concentrate manifold supply. The supply outlet will have a concentrate shut-off valve, Halar® coated concentrate control valve, concentrate piping, a concentrate swing check valve, and an in-line balanced pressure proportioner (ILBP). The individual pilot pressure regulating riser will have a water supply control valve, Viking flow control valve with pressure regulating deluge trim, riser piping, solution test valve and system isolation valve. A manifold supply from a bladder tank to multiple pilot pressure regulating risers allows for individual proportioning at each riser, allowing for different size risers.

<http://www.vikinggroupinc.com/sites/default/files/databook/foam/design/110706.pdf>

Grate Nozzle Pressure Regulating Flow Control System supplied by a Bladder Tank



Detection system detects fire situation due to flame. Electric signal provided to the releasing control panel, which opens solenoid valve and allows deluge flow control valve to open, and foam concentrate valve also opens at the same time, allowing foam concentrate to enter the ILBP foam proportioning system inlet. This discharges foam solution at 3% to discharge from the trench nozzles at 40 psi (2.8 bar) each at the most remote and 47 psi (3.24 bar) at least remote. The complete floor area within 5' (1.5 m) of the perimeter walls and doorways is covered in foam within 3 minutes of system actuation. The discharge pressure from trench nozzles is regulated by the Pressure Regulating Flow Control Valve to maintain a 40 - 47 psi (2.8 to 3.24 bar) discharge pressure. When flow from the trench system occurs, a flow alarm is given from the discharge pressure alarm switch and the detection system.

Grate Nozzle Pressure Regulating Flow Control System supplied by a Foam Pump

Coming Soon

Grate Nozzle Pressure Regulating Flow Control System supplied by an Inductor

Coming Soon

DESCRIPTION	NOMINAL SIZE	PART NUMBER	LIST PRICE (each)
<p>FOAM CONCENTRATE CONTROL VALVE Model F-2 Deluge Valve This valve is HALAR® coated for protection in corrosive environments and can be used with ARC or AFFF foam concentrates.</p> <p><u>Straight Through Deluge Valve</u></p> <p>Groove/Groove</p>  <p>HALAR® Pipe O.D. Model F-2 48mm 1½" / DN40 60mm 2" / DN50 73mm 2½" / DN65 89mm 3" / DN80</p>			
		12127Q/B	\$5,324.43
		12058Q/B	\$5,338.91
		12404Q/B	\$7,186.49
		12023Q/B	\$7,186.49
V233			
<p>FOAM CONCENTRATE CONTROL VALVE Model J-2 Flow Control Valve This valve is HALAR® coated for protection in corrosive environments and can be used with ARC or AFFF foam concentrates.</p> <p><u>Straight Through Flow Control Valve</u> This valve is used in Pressure Regulating Foam Systems</p> <p>Groove/Groove</p>  <p>HALAR® Pipe O.D. Model J-2 48mm 1½" / DN40 60mm 2" / DN50 73mm 2½" / DN65 89mm 3" / DN80</p>			
		12131Q/B	\$6,873.85
		12062Q/B	\$6,892.48
		12408Q/B	\$8,765.29
		12025Q/B	\$8,765.29
V244			
FOAM CONCENTRATE CONTROL VALVE TRIM	Use with Model F Deluge Valve or Model J Flow Control Valve when used as a Concentrate Control Valve for either AR or AFFF foam concentrates.		
	Use with Straight Through Valves		
	Galvanized		
	1½" / DN40	12848-1	\$423.20
	2" / DN50	12848-1	\$423.20
	2½" / DN65	12929-1	\$971.21
	Brass		
	1½" / DN40	12848-2	\$587.13
	2" / DN50	12848-2	\$587.13
	2½" / DN65	12929-2	\$1,059.51
V244			

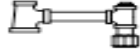

DESCRIPTION	NOMINAL SIZE	PART NUMBER	LIST PRICE (each)
VALVE TRIM FOR PREMIXED FOAM SYSTEMS			
Model J-1 Alarm Valve Trim Variable Pressure V227			
Vertical	Brass		
	3" / DN80	11428	\$2,315.91
	4" / DN100	11429	\$2,702.47
	6" / DN150	11430	\$2,835.90
Horizontal	8" / DN200	11431	\$2,835.90
	3" / DN80	11432	\$2,398.01
	4" / DN100	11433	\$2,839.33
	6" / DN150	11434	\$2,897.51
8" / DN200	11435	\$2,897.51	
Circuit Closer Vent Trim	Brass	8220	\$206.15
			

RELEASE TRIM PACKAGES			
Use with Conventional Trim			
Electric	Brass	10832	\$347.51
Electric/Pneumatic	Brass	12661-2	\$257.80
Pneumatic	Brass	10811	\$308.84
Domestic ¹ Electric	Brass	10832USA	\$463.33
V239			

(1) Meets sourcing requirements of the Buy American Act, American Reinvestment and Recovery Act, and the Buy American Law.

Foam Concentrates

Aqueous Film-Forming Foam (AFFF) IPG V300

Part Number	Description	Gallons/Container	Shipping Weight*	List Price*
 F20335-6.5	AFFF 1%S C6 Concentrate	6.5 gal bucket	61	\$ 1,216.04
F20335-55	AFFF 1%S C6 Concentrate	55 gal drum	500	\$ 10,289.58
F20335-265	AFFF 1%S C6 Concentrate	265 gal tote	2454	\$ 49,577.04
 F20336-6.5	AFFF 3%S C6 Concentrate	6.5 gal bucket	59	\$ 434.46
F20336-55	AFFF 3%S C6 Concentrate	55 gal drum	491	\$ 3,676.23
F20336-265	AFFF 3%S C6 Concentrate	265 gal tote	2389	\$ 17,712.73
 F21719-6.5	AFFF 3%M C6 Concentrate Mil Spec.	6.5 gal bucket	59	\$ 693.25
F21719-55	AFFF 3%M C6 Concentrate Mil Spec.	55 gal drum	491	\$ 5,865.97
F21719-265	AFFF 3%M C6 Concentrate Mil Spec.	265 gal tote	2389	\$ 28,263.30

* Per container

Alcohol-Resistant Foam Concentrate (ARC) IPG V300

Part Number	Description	Gallons/Container	Shipping Weight*	List Price*
 F20227-6.5	ARC 3X3S C6 Concentrate	6.5 gal bucket	59	\$ 783.21
F20227-55	ARC 3X3S C6 Concentrate	55 gal drum	491	\$ 6,627.14
F20227-265	ARC 3X3S C6 Concentrate	265 gal tote	2389	\$ 31,930.75





* Per container

Fluoroprotein (FP) IPG V300

Part Number	Description	Gallons/Container	Shipping Weight*	List Price*
 F20896-6.5	FP 3% C6 Concentrate	6.5 gal bucket	30 lbs	\$ 306.37
F20896-55	FP 3% C6 Concentrate	55 gal drum	488 lbs	\$ 2,592.39
F20896-265	FP 3% C6 Concentrate	265 gal tote	2393 lbs	\$ 12,490.60

* Per container

ACCESSORIES - Foam Systems

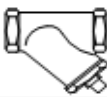
 <p>Pressure Operated Relief Valve (PORV) - Model D-3 1/2" / DN15 Brass 16970 \$ 1,689.02 IPG V242</p>	 <p>Pressure Operated Relief Valve (PORV) - Model D-4 1/2" / DN15 Corrosion Resistant 16971 \$ 2,598.50 IPG V242</p>
 <p>1/8" / 3mm Restricted Orifice 1/2" / DN15 06555A \$ 37.74 IPG V226</p>	 <p>Ball Valve 1/2" / DN15 10355USA \$ 38.89 IPG V226</p>
 <p>Y Strainer 1/2" / DN15 01054A \$ 143.92 IPG V226</p>	<p>CCV - Priming Connection Package Includes: - 1/8" Restricted Orifice <u>10985</u> - Model D-3 PORV \$ 1,093.56 - Soft Seat Check Valve - Ball Valve - Y Strainer</p>
	<p>1/2" Swing Check Valve KT403W-50 \$ 120.89</p>

ACCESSORIES - Foam Systems (continued)

Description	Size	Part Number	List Price
<u>Bladder Tank Water Supply Control Valve</u>			
Thd Butterball® Valve w/ Switches	2" / DN50	BBSCS02-0200	\$ 1,050.35
Ball Valve	1½" / DN40	FBV3C-0150	\$ 154.39
Ball Valve	2" / DN50	FBV3C-0200	\$ 212.29
OS & Y	2½" / DN65	8068A-0250	\$ 1,461.22
OS & Y	3" / DN80	8068A-0300	\$ 1,575.63
* Butterball® is a registered trademark of Milwaukee Valve Co.			
<u>Foam Concentrate Swing Check Valve</u>			
Swing Check Valve	1½" / DN40	99S-0150	\$ 139.86
Swing Check Valve	2" / DN50	99S-0200	\$ 169.90
Swing Check Valve	2½" / DN65	05497C	\$ 661.18
<u>Foam Solution Test Valve</u>			
Grooved Butterfly Valve	2½" / DN65	01G-0250	\$ 1,824.17
Grooved Butterfly Valve	3" / DN80	01G-0300	\$ 1,853.39
Grooved Butterfly Valve	4" / DN100	01G-0400	\$ 1,938.53
Grooved Butterfly Valve	6" / DN150	01G-0600	\$ 2,566.04
Grooved Butterfly Valve	8" / DN200	01G-0800	\$ 3,387.66
<u>System Isolation Valve</u>			
Grooved Butterfly Valve	2½" / DN65	01G-0250	\$ 1,824.17
Grooved Butterfly Valve	3" / DN80	01G-0300	\$ 1,853.39
Grooved Butterfly Valve	4" / DN100	01G-0400	\$ 1,938.53
Grooved Butterfly Valve	6" / DN150	01G-0600	\$ 2,566.04
Grooved Butterfly Valve	8" / DN200	01G-0800	\$ 3,387.66
<u>Water Supply Control Valve</u>			
OS & Y Valve	2½" / DN65	8068A-0250	\$ 1,461.22
OS & Y Valve	3" / DN80	8068A-0300	\$ 1,575.63
OS & Y Valve	4" / DN100	8068A-0400	\$ 1,962.11
OS & Y Valve	6" / DN150	8068A-0600	\$ 2,681.66
OS & Y Valve	8" / DN200	8068A-0800	\$ 3,799.16
<u>Foam Concentrate Shut-Off Valve</u>			
Ball Valve	1½" / DN40	T595Y66-0150	\$ 710.91
Ball Valve	2" / DN50	T595Y66-0200	\$ 1,160.20
Ball Valve	2½" / DN65	T595Y66-0250	\$ 2,435.95
<u>Foam Test Header</u>			
Angle Hose Valve	2½" / DN65	212AHV	\$ 242.65
Angle Hose Valve Cap	2½" / DN65	212HC	\$ 35.00

Proportioning Devices

Concentrate Controllers

IPG V302



Part Number	Description	List Price
F20282A	2" Grooved Controller, AFFF 1%S C6, (50 GPM - 311 GPM)	\$ 1,665.14
F20282B	2" Grooved Controller, AFFF 3%S C6, (50 GPM - 311 GPM)	\$ 1,665.14
F20282J	2" Grooved Controller, ARC 3%J, (100 GPM FM/102 GPM UL - 310 GPM)	\$ 1,665.14
F20282M	2" Grooved Controller, AFFF 3%M C6 Mil-Spec, (50 GPM - 311 GPM)	\$ 1,665.14
F20162A	2.5" Grooved Controller, AFFF 1%S C6, (50 GPM - 475 GPM)	\$ 2,565.41
F20162B	2.5" Grooved Controller, AFFF 3%S C6, (50 GPM - 475 GPM)	\$ 2,565.41
F20162J	2.5" Grooved Controller, ARC 3%J C6, (160 GPM FM/165 GPM UL - 475 GPM)	\$ 2,565.41
F20162M	2.5" Grooved Controller, AFFF 3%M C6 Mil-Spec, (50 GPM - 475 GPM)	\$ 2,565.41
F20152A	3" Grooved Controller, AFFF 1%S C6, (50 GPM - 750 GPM)	\$ 2,808.08
F20152B	3" Grooved Controller, AFFF 3%S C6, (50 GPM - 750 GPM)	\$ 2,808.08
F20152J	3" Grooved Controller, ARC 3%J C6, (300 GPM - 750 GPM)	\$ 2,808.08
F20152M	3" Grooved Controller, AFFF 3%M C6 Mil-Spec, (50 GPM - 750 GPM)	\$ 2,808.08
F20217A	4" Grooved Controller, AFFF 1%S C6, (50 GPM - 1250 GPM)	\$ 3,255.35
F20217B	4" Grooved Controller, AFFF 3%S C6, (50 GPM - 1250 GPM)	\$ 3,255.35
F20217J	4" Grooved Controller, ARC 3%J C6, (50 GPM - 1250 GPM)	\$ 3,255.35
F20217M	4" Grooved Controller, AFFF 3%M C6 Mil-Spec, (400 GPM - 475 GPM)	\$ 3,255.35
F20214A	6" Grooved Controller, AFFF 1%S C6, (140 GPM - 2300 GPM)	\$ 4,690.13
F20214B	6" Grooved Controller, AFFF 3%S C6, (70 GPM - 2300 GPM)	\$ 4,690.13
F20214J	6" Grooved Controller, ARC 3%J C6, (750 GPM - 2300 GPM)	\$ 4,690.13
F20214M	6" Grooved Controller, AFFF 3%M C6 Mil-Spec, (70 GPM - 2300 GPM)	\$ 4,690.13
F20137A	8" Grooved Controller, AFFF 1%S C6, (200 GPM - 4500 GPM)	\$ 7,727.39
F20137B	8" Grooved Controller, AFFF 3%S C6, (70 GPM - 4500 GPM)	\$ 7,727.39
F20137J	8" Grooved Controller, ARC 3%J C6, (1400 GPM - 4500 GPM)	\$ 7,727.39
F20137M	8" Grooved Controller, AFFF 3%M C6 Mil-Spec, (70 GPM - 4500 GPM)	\$ 7,727.39

In-Line Balanced Proportioners (ILBPs)

IPG V302



Part Number	Description	List Price
F20316A	3" ILBP 1%S AFFF, (50 GPM - 750 GPM)	\$ 16,096.31
F20316B	3" ILBP 3% AFFF, (100 GPM - 750 GPM)	\$ 16,096.31
F20316J	3" ILBP 3% AR-AFFF, (200 GPM - 750 GPM)	\$ 16,096.31
F20316M	3" ILBP 3% Mil Spec, (50 GPM - 750 GPM)	\$ 16,096.31
F20317A	4" ILBP 1%S AFFF, (500 GPM FM/250 GPM UL - 1250 GPM)	\$ 17,206.40
F20317B	4" ILBP 3% AFFF, (400 GPM - 1250 GPM)	\$ 17,206.40
F20317J	4" ILBP 3% AR-AFFF, (450 GPM FM/400 GPM UL - 1250 GPM)	\$ 17,206.40
F20317M	4" ILBP 3% Mil Spec, (400 GPM - 1250 GPM)	\$ 17,206.40
F20184A	6" ILBP 1%S AFFF, (500 GPM - 2300 GPM)	\$ 19,704.10
F20184B	6" ILBP 3% AFFF, (600 GPM - 2300 GPM)	\$ 19,704.10
F20184J	6" ILBP 3% AR-AFFF, (850 GPM - 2300 GPM)	\$ 19,704.10
F20184M	6" ILBP 3% Mil Spec, (600 GPM - 2300 GPM)	\$ 19,704.10
F20185A	8" ILBP 1%S AFFF, (1550 GPM FM/1300 GPM UL - 4500 GPM)	\$ 21,646.75
F20185B	8" ILBP 3% AFFF, (1300 GPM - 4500 GPM)	\$ 21,646.75
F20185J	8" ILBP 3% AR-AFFF, (1553 GPM FM/1634 GPM UL - 4500 GPM)	\$ 21,646.75
F20185M	8" ILBP 3% Mil Spec, (1300 GPM - 4500 GPM)	\$ 21,646.75

Proportioning Devices (continued)

BFZ Between Flange Inductor **IPG V304**



Part Number	Description	List Price
F15922	4" BFZ Inductor, (145 GPM - 872 GPM)	\$15,914.32
F15923	6" BFZ Inductor, (291 GPM - 1744 GPM)	\$29,736.80
F15924	8" BFZ Inductor, (436 GPM - 2615 GPM)	\$43,098.60
F15925	8"S BFZ Inductor, (436 GPM - 4359 GPM)	\$48,869.95

FomTec Inductor requirements prior to order:

- 1) Required flow rate
- 2) Required pressure at the inlet of the inductor
- 3) Required pressure at the outlet of the inductor
- 4) Centerline of foam inlet above the bottom of atmospheric storage tank
- 5) Type of foam concentrate

Hand Line Eductors **IPG V304**



Part Number	Description	List Price
F20963	1-1/2" FE 90 FP 6% UL, 95 GPM	\$2,806.26
F20964	1-1/2" FE 90 FP 3% UL, 95 GPM	\$2,806.26
F20961	1-1/2" FE 90 ARC 3X3S, 95 GPM	\$2,806.26
F20962	1-1/2" FE 90 AFFF 1%S, 95 GPM	\$2,806.26
F09181	1-1/2" FE 90 AFFF 3%S , 95 GPM	\$2,806.26

Eductors are supplied with a metering orifice and nozzle configuration based upon the information received at order state. Pick-up Tube with check valve is also included.

Discharge Devices

Viking GN201 Grate Nozzle®		IPG V307
Part Number	Description	List Price
F21949	GN201, 360° Pattern, Grooved, 26" Grate Nozzle*, UL/FM, AFFF 1%S	\$ 8,623.91
	GN201, 360° Pattern, Grooved, 26" Grate Nozzle*, UL/FM, AFFF 3%S	\$ 8,623.91
	GN201, 360° Pattern, Grooved, 26" Grate Nozzle*, UL/FM, AFFF 3%M Mil-Spec	\$ 8,623.91
F21996	GN201, 360° Pattern, Grooved, 20" Grate Nozzle*, UL/FM, AFFF 1%S	\$ 8,623.91
	GN201, 360° Pattern, Grooved, 20" Grate Nozzle*, UL/FM, AFFF 3%S	\$ 8,623.91
	GN201, 360° Pattern, Grooved, 20" Grate Nozzle*, UL/FM, AFFF 3%M Mil-Spec	\$ 8,623.91
F21948	GN201, 180° Pattern, Grooved, 26" Grate Nozzle*, UL/FM, AFFF 1%S	\$ 8,623.91
	GN201, 180° Pattern, Grooved, 26" Grate Nozzle*, UL/FM, AFFF 3%S	\$ 8,623.91
	GN201, 180° Pattern, Grooved, 26" Grate Nozzle*, UL/FM, AFFF 3%M Mil-Spec	\$ 8,623.91
F21995	GN201, 180° Pattern, Grooved, 20" Grate Nozzle*, UL/FM, AFFF 1%S	\$ 8,623.91
	GN201, 180° Pattern, Grooved, 20" Grate Nozzle*, UL/FM, AFFF 3%S	\$ 8,623.91
	GN201, 180° Pattern, Grooved, 20" Grate Nozzle*, UL/FM, AFFF 3%M Mil-Spec	\$ 8,623.91
F21947	GN201, 90° Pattern, Grooved, 26" Grate Nozzle*, UL/FM, AFFF 1%S	\$ 8,623.91
	GN201, 90° Pattern, Grooved, 26" Grate Nozzle*, UL/FM, AFFF 3%S	\$ 8,623.91
	GN201, 90° Pattern, Grooved, 26" Grate Nozzle*, UL/FM, AFFF 3%M Mil-Spec	\$ 8,623.91
F21994	GN201, 90° Pattern, Grooved, 20" Grate Nozzle*, UL/FM, AFFF 1%S	\$ 8,623.91
	GN201, 90° Pattern, Grooved, 20" Grate Nozzle*, UL/FM, AFFF 3%S	\$ 8,623.91
	GN201, 90° Pattern, Grooved, 20" Grate Nozzle*, UL/FM, AFFF 3%M Mil-Spec	\$ 8,623.91
F22018	GN201, 360° Pattern, Grooved, 555 mm Grate Nozzle*, UL/FM, AFFF 1%S	\$ 8,623.91
	GN201, 360° Pattern, Grooved, 555 mm Grate Nozzle*, UL/FM, AFFF 3%S	\$ 8,623.91
	GN201, 360° Pattern, Grooved, 555 mm Grate Nozzle*, UL/FM, AFFF 3%M Mil-Spec	\$ 8,623.91
F22017	GN201, 180° Pattern, Grooved, 555 mm Grate Nozzle*, UL/FM, AFFF 1%S	\$ 8,623.91
	GN201, 180° Pattern, Grooved, 555 mm Grate Nozzle*, UL/FM, AFFF 3%S	\$ 8,623.91
	GN201, 180° Pattern, Grooved, 555 mm Grate Nozzle*, UL/FM, AFFF 3%M Mil-Spec	\$ 8,623.91
F22016	GN201, 90° Pattern, Grooved, 555 mm Grate Nozzle*, UL/FM, AFFF 1%S	\$ 8,623.91
	GN201, 90° Pattern, Grooved, 555 mm Grate Nozzle*, UL/FM, AFFF 3%S	\$ 8,623.91
	GN201, 90° Pattern, Grooved, 555 mm Grate Nozzle*, UL/FM, AFFF 3%M Mil-Spec	\$ 8,623.91



Strainers are to be Stainless Steel with a mesh screen no greater than 1/8" perforation.

Viking GN200 Grate Nozzle®		IPG V307
Part Number	Description	List Price
F02012	GN200, 360° Pattern, Grooved, 26" Grate Nozzle*, UL, AFFF 1%S	\$ 9,055.10
	GN200, 360° Pattern, Grooved, 26" Grate Nozzle*, UL, AFFF 3%S	\$ 9,055.10
	GN200, 360° Pattern, Grooved, 26" Grate Nozzle*, UL, AFFF 3%M Mil-Spec	\$ 9,055.10
F02022	GN200, 360° Pattern, Grooved, 20" Grate Nozzle*, UL, AFFF 1%S	\$ 9,055.10
	GN200, 360° Pattern, Grooved, 20" Grate Nozzle*, UL, AFFF 3%S	\$ 9,055.10
	GN200, 360° Pattern, Grooved, 20" Grate Nozzle*, UL, AFFF 3%M Mil-Spec	\$ 9,055.10
F13689	GN200, 180° Pattern, Grooved, 26" Grate Nozzle*, UL, AFFF 1%S	\$ 8,623.91
	GN200, 180° Pattern, Grooved, 26" Grate Nozzle*, UL, AFFF 3%S	\$ 8,623.91
	GN200, 180° Pattern, Grooved, 26" Grate Nozzle*, UL, AFFF 3%M Mil-Spec	\$ 8,623.91
F13690	GN200, 180° Pattern, Grooved, 20" Grate Nozzle*, UL, AFFF 1%S	\$ 8,623.91
	GN200, 180° Pattern, Grooved, 20" Grate Nozzle*, UL, AFFF 3%S	\$ 8,623.91
	GN200, 180° Pattern, Grooved, 20" Grate Nozzle*, UL, AFFF 3%M Mil-Spec	\$ 8,623.91
F13686	GN200, 90° Pattern, Grooved, 26" Grate Nozzle*, UL, AFFF 1%S	\$ 8,623.91
	GN200, 90° Pattern, Grooved, 26" Grate Nozzle*, UL, AFFF 3%S	\$ 8,623.91
	GN200, 90° Pattern, Grooved, 26" Grate Nozzle*, UL, AFFF 3%M Mil-Spec	\$ 8,623.91
F13687	GN200, 90° Pattern, Grooved, 20" Grate Nozzle*, UL, AFFF 1%S	\$ 8,623.91
	GN200, 90° Pattern, Grooved, 20" Grate Nozzle*, UL, AFFF 3%S	\$ 8,623.91
	GN200, 90° Pattern, Grooved, 20" Grate Nozzle*, UL, AFFF 3%M Mil-Spec	\$ 8,623.91



Strainers are to be Stainless Steel with a mesh screen no greater than 1/16" perforation.

* 11 inch width

Discharge Devices (continued)

Foam Chambers			IPG V305
Part Number	Description		List Price
F20904	2.5" Foam Chamber	Carbon Steel	\$ 3,202.77
F20941	Split Deflector	Carbon Steel	\$ 323.42
F20937	Solid Deflector	Carbon Steel	\$ 323.42
F20919	Mounting flange with studs	Carbon Steel	\$ 553.21
F20906	2.5" Foam Chamber	Stainless Steel 316	\$ 9,545.45
F20942	Split Deflector	Stainless Steel 316	\$ 970.26
F20938	Solid Deflector	Stainless Steel 316	\$ 970.26
F20921	Mounting flange with studs	Stainless Steel 316	\$ 1,659.62
F21203	3" Foam Chamber	Carbon Steel	\$ 3,748.70
F21169	Split Deflector	Carbon Steel	\$ 414.81
F21157	Solid Deflector	Carbon Steel	\$ 414.81
F21181	Mounting flange with studs	Carbon Steel	\$ 638.96
F21205	3" Foam Chamber	Stainless Steel 316	\$ 11,080.65
F21170	Split Deflector	Stainless Steel 316	\$ 1,244.48
F21158	Solid Deflector	Stainless Steel 316	\$ 1,244.48
F21183	Mounting flange with studs	Stainless Steel 316	\$ 1,916.90
F21207	4" Foam Chamber	Carbon Steel	\$ 4,119.27
F21173	Split Deflector	Carbon Steel	\$ 485.98
F21161	Solid Deflector	Carbon Steel	\$ 485.98
F21185	Mounting flange with studs	Carbon Steel	\$ 704.94
F21209	4" Foam Chamber	Stainless Steel 316	\$ 13,959.17
F21174	Split Deflector	Stainless Steel 316	\$ 1,457.92
F21162	Solid Deflector	Stainless Steel 316	\$ 1,457.92
F21187	Mounting flange with studs	Stainless Steel 316	\$ 2,114.89
F21211	6" Foam Chamber	Carbon Steel	\$ 5,915.86
F21177	Split Deflector	Carbon Steel	\$ 537.16
F21165	Solid Deflector	Carbon Steel	\$ 537.16
F21189	Mounting flange with studs	Carbon Steel	\$ 1,004.94
F21213	6" Foam Chamber	Stainless Steel 316	\$ 21,082.69
F21178	Split Deflector	Stainless Steel 316	\$ 1,611.47
F21166	Solid Deflector	Stainless Steel 316	\$ 1,611.47
F21191	Mounting flange with studs	Stainless Steel 316	\$ 4,355.77

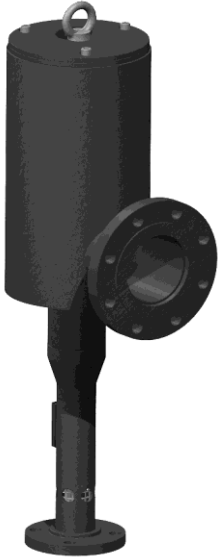

Foam Makers and Foam Pourers			IPG V306
Part Number	Description		List Price
F21216	1-1/2" Foam Maker ANSI		\$ 1,094.51
F21218	1-1/2" Foam Maker ANSI SS		\$ 3,283.52
F21221	2-1/2" Foam Maker ANSI		\$ 1,878.03
F21223	2-1/2" Foam Maker ANSI SS		\$ 5,634.08
F21226	3" Foam Maker ANSI		\$ 2,277.87
F21228	3" Foam Maker ANSI SS		\$ 6,833.61
F21231	4" Foam Maker ANSI		\$ 3,037.16
F21233	4" Foam Maker ANSI SS		\$ 9,111.47



Part Number	Description		List Price
F21255	1.5"/2.5" Foam Pourer ANSI		\$ 484.65
F21257	1.5"/2.5" Foam Pourer ANSI SST		\$ 1,453.96
F21259	3" Foam Pourer ANSI		\$ 605.82
F21261	3" Foam Pourer ANSI SST		\$ 1,817.45
F21263	4" Foam Pourer ANSI		\$ 787.56
F21265	4" Foam Pourer ANSI SST		\$ 2,362.68

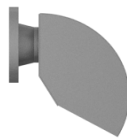

Discharge Devices (continued)

Bladder Tank Foam Hose Station IPG V305



Part Number	Description	List Price
VFS0036HA	36 Gallon Bladder Tank Foam Station w/Hose for AFFF 1%S	P.O.A.
VFS0036HB	36 Gallon Bladder Tank Foam Station w/Hose for AFFF 3%S	P.O.A.

Approved Sprinklers for use with Foam Concentrates



Viking Pendent and Upright Foam-Water Sprinklers are non-aspirated foam discharge outlets for use in Wet, Deluge and Preaction Systems

Refer to Page F_091316 for listing of sprinklers that are UL Listed and FM Approved.
<http://www.vikinggroupinc.com/sites/default/files/documents/091316.pdf>

Foam Bladder Tanks

Vertical Bladder Tanks			IPG V301
Capacity	Part Number	List Price	
25 Gallon	VFTV0025U	\$ 28,623.29	
36 Gallon	VFTV0036U	\$ 29,798.27	
50 Gallon	VFTV0050U	\$ 34,498.78	
75 Gallon	VFTV0075U	\$ 37,091.48	
100 Gallon	VFTV0100U	\$ 37,960.19	
150 Gallon	VFTV0150U	\$ 42,641.51	
200 Gallon	VFTV0200U	\$ 46,722.25	
250 Gallon	VFTV0250U	\$ 48,146.01	
300 Gallon	VFTV0300U	\$ 51,206.34	
350 Gallon	VFTV0350U	\$ 56,540.05	
400 Gallon	VFTV0400U	\$ 59,957.07	
450 Gallon	VFTV0450U	\$ 61,508.59	
500 Gallon	VFTV0500U	\$ 64,522.48	
600 Gallon	VFTV0600U	\$ 69,833.00	
700 Gallon	VFTV0700U	\$ 75,269.72	
800 Gallon	VFTV0800U	\$ 84,101.77	
900 Gallon	VFTV0900U	\$ 88,159.70	
1000 Gallon	VFTV1000U	\$ 101,308.13	
1100 Gallon	VFTV1100U	\$ 107,951.43	
1200 Gallon	VFTV1200U	\$ 108,855.94	
1300 Gallon	VFTV1300U	\$ 116,714.55	
1400 Gallon	VFTV1400U	\$ 123,195.31	
1500 Gallon	VFTV1500U	\$ 126,569.89	
1600 Gallon	VFTV1600U	\$ 133,836.24	
1700 Gallon	VFTV1700U	\$ 136,004.84	
1800 Gallon	VFTV1800U	\$ 139,801.53	
1900 Gallon	VFTV1900U	\$ 142,400.64	
2000 Gallon	VFTV2000U	\$ 144,999.81	
2200 Gallon	VFTV2200U	\$ 173,166.04	
2400 Gallon	VFTV2400U	\$ 181,294.43	
2600 Gallon	VFTV2600U	\$ 189,731.55	
2800 Gallon	VFTV2800U	\$ 197,767.54	
3000 Gallon	VFTV3000U	\$ 204,404.37	
3200 Gallon	VFTV3200U	\$ 213,473.39	
3400 Gallon	VFTV3400U	\$ 221,497.95	
3600 Gallon	VFTV3600U	\$ 225,663.31	
3800 Gallon	VFTV3800U	\$ 230,744.89	
4000 Gallon	VFTV4000U	\$ 238,274.97	

Horizontal Bladder Tanks			IPG V301
Capacity	Part Number	List Price	
50 Gallon	VFTH0050U	\$ 39,576.49	
75 Gallon	VFTH0075U	\$ 40,324.60	
100 Gallon	VFTH0100U	\$ 41,947.80	
150 Gallon	VFTH0150U	\$ 46,599.83	
200 Gallon	VFTH0200U	\$ 49,639.66	
250 Gallon	VFTH0250U	\$ 54,470.95	
300 Gallon	VFTH0300U	\$ 55,812.52	
350 Gallon	VFTH0350U	\$ 59,601.99	
400 Gallon	VFTH0400U	\$ 62,988.82	
450 Gallon	VFTH0450U	\$ 66,105.28	
500 Gallon	VFTH0500U	\$ 68,395.55	
600 Gallon	VFTH0600U	\$ 71,812.89	
700 Gallon	VFTH0700U	\$ 82,492.00	
800 Gallon	VFTH0800U	\$ 88,985.10	
900 Gallon	VFTH0900U	\$ 93,928.68	
1000 Gallon	VFTH1000U	\$ 101,057.89	
1100 Gallon	VFTH1100U	\$ 104,972.74	
1200 Gallon	VFTH1200U	\$ 111,579.64	
1300 Gallon	VFTH1300U	\$ 123,164.78	
1400 Gallon	VFTH1400U	\$ 126,152.96	
1500 Gallon	VFTH1500U	\$ 130,346.41	
1600 Gallon	VFTH1600U	\$ 132,006.77	
1700 Gallon	VFTH1700U	\$ 136,867.08	
1800 Gallon	VFTH1800U	\$ 142,613.34	
1900 Gallon	VFTH1900U	\$ 151,526.79	
2000 Gallon	VFTH2000U	\$ 172,982.68	
2200 Gallon	VFTH2200U	\$ 182,054.79	
2400 Gallon	VFTH2400U	\$ 190,632.83	
2600 Gallon	VFTH2600U	\$ 197,127.39	
2800 Gallon	VFTH2800U	\$ 205,791.29	
3000 Gallon	VFTH3000U	\$ 216,681.55	
3200 Gallon	VFTH3200U	\$ 226,665.29	
3400 Gallon	VFTH3400U	\$ 234,275.50	
3600 Gallon	VFTH3600U	\$ 238,804.24	
3800 Gallon	VFTH3800U	\$ 244,913.41	
4000 Gallon	VFTH4000U	\$ 252,038.19	
4250 Gallon	VFTH4250U	\$ 261,649.92	
4500 Gallon	VFTH4500U	\$ 267,945.81	
4750 Gallon	VFTH4750U	\$ 274,239.20	
5000 Gallon	VFTH5000U	\$ 280,537.61	
5250 Gallon	VFTH5250U	\$ 286,829.82	



* Bladder tank assemblies include water drain/fill valve, fill line master shut-off valve, concentrate drain/fill valve, fill cup, sight gauge shut-off valve, sight gauge assembly, tank water vent valve, and diaphragm concentrate vent valve.

Double Wall (SAFE) Atmospheric Storage Tanks

Top Discharge Double Wall (SAFE) Atmospheric Storage Tanks IPG V311



These SAFE Atmospheric Storage Tanks are for use with the BFZ Inductor type foam systems or Foam Pump Systems

Part Number	Description	List Price
F20396A1123	105 Gallon SAFE Atmospheric Storage Tank w/1-1/2" fittings & level indicator	\$14,826.57
F20396B23	105 Gallon SAFE Atmospheric Storage Tank w/2" fittings & level indicator	\$14,757.98
F20396C2123	105 Gallon SAFE Atmospheric Storage Tank w/2-1/2" fittings & level indicator	\$16,926.23
F20396D33	105 Gallon SAFE Atmospheric Storage Tank w/3" fittings & level indicator	\$16,800.08
F20003A1123	160 Gallon SAFE Atmospheric Storage Tank w/1-1/2" fittings & level indicator	\$15,937.25
F20003B23	160 Gallon SAFE Atmospheric Storage Tank w/2" fittings & level indicator	\$15,868.66
F20003C2123	160 Gallon SAFE Atmospheric Storage Tank w/2-1/2" fittings & level indicator	\$18,036.92
F20003D33	160 Gallon SAFE Atmospheric Storage Tank w/3" fittings & level indicator	\$17,910.76
F22240A1123	250 Gallon SAFE Atmospheric Storage Tank w/1-1/2" fittings & level indicator	\$15,736.02
F22240B23	250 Gallon SAFE Atmospheric Storage Tank w/2" fittings & level indicator	\$15,761.50
F22240C2123	250 Gallon SAFE Atmospheric Storage Tank w/2-1/2" fittings & level indicator	\$17,523.64
F22240D33	250 Gallon SAFE Atmospheric Storage Tank w/3" fittings & level indicator	\$17,600.07
F20004A1123	405 Gallon SAFE Atmospheric Storage Tank w/1-1/2" fittings & level indicator	\$16,833.60
F20004B23	405 Gallon SAFE Atmospheric Storage Tank w/2" fittings & level indicator	\$16,765.00
F20004C2123	405 Gallon SAFE Atmospheric Storage Tank w/2-1/2" fittings & level indicator	\$18,933.26
F20004D33	405 Gallon SAFE Atmospheric Storage Tank w/3" fittings & level indicator	\$18,807.11
F20005A1123	540 Gallon SAFE Atmospheric Storage Tank w/1-1/2" fittings & level indicator	\$22,520.02
F20005B23	540 Gallon SAFE Atmospheric Storage Tank w/2" fittings & level indicator	\$22,451.44
F20005C2123	540 Gallon SAFE Atmospheric Storage Tank w/2-1/2" fittings & level indicator	\$24,580.73
F20005D33	540 Gallon SAFE Atmospheric Storage Tank w/3" fittings & level indicator	\$24,454.56
F20014A1123	750 Gallon SAFE Atmospheric Storage Tank w/1-1/2" fittings & level indicator	\$27,388.65
F20014B23	750 Gallon SAFE Atmospheric Storage Tank w/2" fittings & level indicator	\$27,320.05
F20014C2123	750 Gallon SAFE Atmospheric Storage Tank w/2-1/2" fittings & level indicator	\$29,792.72
F20014D33	750 Gallon SAFE Atmospheric Storage Tank w/3" fittings & level indicator	\$29,666.55
F20006A1123	1000 Gallon SAFE Atmospheric Storage Tank w/1-1/2" fittings & level indicator	\$29,176.34
F20006B23	1000 Gallon SAFE Atmospheric Storage Tank w/2" fittings & level indicator	\$29,107.75
F20006C2123	1000 Gallon SAFE Atmospheric Storage Tank w/2-1/2" fittings & level indicator	\$31,237.04
F20006D33	1000 Gallon SAFE Atmospheric Storage Tank w/3" fittings & level indicator	\$31,110.89
F20007A1123	1550 Gallon SAFE Atmospheric Storage Tank w/1-1/2" fittings & level indicator	\$32,547.37
F20007B23	1550 Gallon SAFE Atmospheric Storage Tank w/2" fittings & level indicator	\$32,478.78
F20007C2123	1550 Gallon SAFE Atmospheric Storage Tank w/2-1/2" fittings & level indicator	\$34,608.06
F20007D33	1550 Gallon SAFE Atmospheric Storage Tank w/3" fittings & level indicator	\$34,481.91
F20008A1123	2500 Gallon SAFE Atmospheric Storage Tank w/1-1/2" fittings & level indicator	\$47,972.25
F20008B23	2500 Gallon SAFE Atmospheric Storage Tank w/2" fittings & level indicator	\$47,903.66
F20008C2123	2500 Gallon SAFE Atmospheric Storage Tank w/2-1/2" fittings & level indicator	\$49,690.00
F20008D33	2500 Gallon SAFE Atmospheric Storage Tank w/3" fittings & level indicator	\$49,563.85
F20009A1123	3150 Gallon SAFE Atmospheric Storage Tank w/1-1/2" fittings & level indicator	\$54,461.00
F20009B23	3150 Gallon SAFE Atmospheric Storage Tank w/2" fittings & level indicator	\$54,392.41
F20009C2123	3150 Gallon SAFE Atmospheric Storage Tank w/2-1/2" fittings & level indicator	\$56,178.75
F20009D33	3150 Gallon SAFE Atmospheric Storage Tank w/3" fittings & level indicator	\$56,052.59
F20010A1123	4400 Gallon SAFE Atmospheric Storage Tank w/1-1/2" fittings & level indicator	\$73,101.03
F20010B23	4400 Gallon SAFE Atmospheric Storage Tank w/2" fittings & level indicator	\$73,032.44
F20010C2123	4400 Gallon SAFE Atmospheric Storage Tank w/2-1/2" fittings & level indicator	\$74,818.78
F20010D33	4400 Gallon SAFE Atmospheric Storage Tank w/3" fittings & level indicator	\$74,692.62
F20011A1123	5400 Gallon SAFE Atmospheric Storage Tank w/1-1/2" fittings & level indicator	\$79,880.94
F20011B23	5400 Gallon SAFE Atmospheric Storage Tank w/2" fittings & level indicator	\$79,363.08
F20011C2123	5400 Gallon SAFE Atmospheric Storage Tank w/2-1/2" fittings & level indicator	\$81,599.80
F20011D33	5400 Gallon SAFE Atmospheric Storage Tank w/3" fittings & level indicator	\$81,473.65
F20397A1123	6550 Gallon SAFE Atmospheric Storage Tank w/1-1/2" fittings & level indicator	\$88,701.65
F20397B23	6550 Gallon SAFE Atmospheric Storage Tank w/2" fittings & level indicator	\$88,632.99
F20397C2123	6550 Gallon SAFE Atmospheric Storage Tank w/2-1/2" fittings & level indicator	\$90,421.14
F20397D33	6550 Gallon SAFE Atmospheric Storage Tank w/3" fittings & level indicator	\$90,294.86
F20013A1123	8700 Gallon SAFE Atmospheric Storage Tank w/1-1/2" fittings & level indicator	\$122,068.61
F20013B23	8700 Gallon SAFE Atmospheric Storage Tank w/2" fittings & level indicator	\$122,000.02
F20013C2123	8700 Gallon SAFE Atmospheric Storage Tank w/2-1/2" fittings & level indicator	\$123,786.36
F20013D33	8700 Gallon SAFE Atmospheric Storage Tank w/3" fittings & level indicator	\$123,660.20

Above tanks include Primary Tank, Containment Tank, Lid/Manway, Drop Tube Suction Connection, Drop Tube Fill Connection, Pressure Vacuum Vent and Reverse Level Float Gauge

Single Wall Atmospheric Storage Tanks

Single Wall Vertical Atmospheric Storage Tanks (Top Discharge Connections)			IPG V312
Part Number	Description	List Price	
100GVERT2TC	100 Gallon Single Wall Atmospheric Storage Tank w/2" fittings & level indicator	\$	10,040.25
100GVERT212TC	100 Gallon Single Wall Atmospheric Storage Tank w/2-1/2" fittings & level indicator	\$	13,526.66
155GVERT2TC	155 Gallon Single Wall Atmospheric Storage Tank w/2" fittings & level indicator	\$	10,091.98
155GVERT212TC	155 Gallon Single Wall Atmospheric Storage Tank w/2-1/2" fittings & level indicator	\$	13,578.40
205GVERT2TC	205 Gallon Single Wall Atmospheric Storage Tank w/2" fittings & level indicator	\$	11,540.34
205GVERT212TC	205 Gallon Single Wall Atmospheric Storage Tank w/2-1/2" fittings & level indicator	\$	15,026.76
300GVERT2TC	300 Gallon Single Wall Atmospheric Storage Tank w/2" fittings & level indicator	\$	11,721.38
300GVERT212TC	300 Gallon Single Wall Atmospheric Storage Tank w/2-1/2" fittings & level indicator	\$	15,207.80
400GVERT2TC	400 Gallon Single Wall Atmospheric Storage Tank w/2" fittings & level indicator	\$	13,945.65
400GVERT212TC	400 Gallon Single Wall Atmospheric Storage Tank w/2-1/2" fittings & level indicator	\$	17,432.07
540GVERT2TC	540 Gallon Single Wall Atmospheric Storage Tank w/2" fittings & level indicator	\$	13,397.35
540GVERT212TC	540 Gallon Single Wall Atmospheric Storage Tank w/2-1/2" fittings & level indicator	\$	16,883.75
615GVERT2TC	615 Gallon Single Wall Atmospheric Storage Tank w/2" fittings & level indicator	\$	17,613.12
615GVERT212TC	615 Gallon Single Wall Atmospheric Storage Tank w/2-1/2" fittings & level indicator	\$	21,099.52
755GVERT2TC	755 Gallon Single Wall Atmospheric Storage Tank w/2" fittings & level indicator	\$	18,130.39
755GVERT212TC	755 Gallon Single Wall Atmospheric Storage Tank w/2-1/2" fittings & level indicator	\$	21,616.80
805GVERT2TC	805 Gallon Single Wall Atmospheric Storage Tank w/2" fittings & level indicator	\$	17,354.48
805GVERT212TC	805 Gallon Single Wall Atmospheric Storage Tank w/2-1/2" fittings & level indicator	\$	20,840.89
905GVERT2TC	905 Gallon Single Wall Atmospheric Storage Tank w/2" fittings & level indicator	\$	17,587.25
905GVERT212TC	905 Gallon Single Wall Atmospheric Storage Tank w/2-1/2" fittings & level indicator	\$	21,073.66
1000GVERT2TC	1000 Gallon Single Wall Atmospheric Storage Tank w/2" fittings & level indicator	\$	18,989.05
1000GVERT212TC	1000 Gallon Single Wall Atmospheric Storage Tank w/2-1/2" fittings & level indicator	\$	22,040.96
1150GVERT2TC	1150 Gallon Single Wall Atmospheric Storage Tank w/2" fittings & level indicator	\$	18,057.96
1150GVERT212TC	1150 Gallon Single Wall Atmospheric Storage Tank w/2-1/2" fittings & level indicator	\$	21,109.88



These Atmospheric Storage Tanks are for use with the BFZ Inductor type foam systems or Foam Pump Systems

Above tanks include Tank, Lid/Manway, Drop Tube Suction Connection, Drop Tube Fill Connection, Vent and Ultrasonic Level Indicator

Single Wall Vertical Atmospheric Storage Tanks (Side Connections)			IPG V312
Part Number	Description	List Price	
100GVERT2SC	100 Gallon Single Wall Atmospheric Storage Tank w/2" fittings & level indicator	\$	17,944.17
100GVERT212SC	100 Gallon Single Wall Atmospheric Storage Tank w/2-1/2" fittings & level indicator	\$	23,427.25
155GVERT2SC	155 Gallon Single Wall Atmospheric Storage Tank w/2" fittings & level indicator	\$	17,995.89
155GVERT212SC	155 Gallon Single Wall Atmospheric Storage Tank w/2-1/2" fittings & level indicator	\$	23,478.97
205GVERT2SC	205 Gallon Single Wall Atmospheric Storage Tank w/2" fittings & level indicator	\$	19,444.25
205GVERT212SC	205 Gallon Single Wall Atmospheric Storage Tank w/2-1/2" fittings & level indicator	\$	24,927.35
300GVERT2SC	300 Gallon Single Wall Atmospheric Storage Tank w/2" fittings & level indicator	\$	19,625.30
300GVERT212SC	300 Gallon Single Wall Atmospheric Storage Tank w/2-1/2" fittings & level indicator	\$	25,108.38
400GVERT2SC	400 Gallon Single Wall Atmospheric Storage Tank w/2" fittings & level indicator	\$	21,849.57
400GVERT212SC	400 Gallon Single Wall Atmospheric Storage Tank w/2-1/2" fittings & level indicator	\$	27,332.66
540GVERT2SC	540 Gallon Single Wall Atmospheric Storage Tank w/2" fittings & level indicator	\$	21,301.26
540GVERT212SC	540 Gallon Single Wall Atmospheric Storage Tank w/2-1/2" fittings & level indicator	\$	26,784.34
615GVERT2SC	615 Gallon Single Wall Atmospheric Storage Tank w/2" fittings & level indicator	\$	25,517.03
615GVERT212SC	615 Gallon Single Wall Atmospheric Storage Tank w/2-1/2" fittings & level indicator	\$	31,000.11
755GVERT2SC	755 Gallon Single Wall Atmospheric Storage Tank w/2" fittings & level indicator	\$	26,034.30
755GVERT212SC	755 Gallon Single Wall Atmospheric Storage Tank w/2-1/2" fittings & level indicator	\$	31,517.39
805GVERT2SC	805 Gallon Single Wall Atmospheric Storage Tank w/2" fittings & level indicator	\$	25,258.40
805GVERT212SC	805 Gallon Single Wall Atmospheric Storage Tank w/2-1/2" fittings & level indicator	\$	30,741.48
905GVERT2SC	905 Gallon Single Wall Atmospheric Storage Tank w/2" fittings & level indicator	\$	25,491.16
905GVERT212SC	905 Gallon Single Wall Atmospheric Storage Tank w/2-1/2" fittings & level indicator	\$	30,974.25
1000GVERT2SC	1000 Gallon Single Wall Atmospheric Storage Tank w/2" fittings & level indicator	\$	26,892.98
1000GVERT212SC	1000 Gallon Single Wall Atmospheric Storage Tank w/2-1/2" fittings & level indicator	\$	31,941.55
1150GVERT2SC	1150 Gallon Single Wall Atmospheric Storage Tank w/2" fittings & level indicator	\$	25,961.89
1150GVERT212SC	1150 Gallon Single Wall Atmospheric Storage Tank w/2-1/2" fittings & level indicator	\$	31,010.45



These Atmospheric Storage Tanks are for use with the BFZ Inductor type foam systems or Foam Pump Systems

Above tanks include Tank, Lid/Manway, Side Drain Connection, Side Suction Flexible Connection, Side Return Flexible Connection, Top Fill Connection, Pressure Vacuum Vent and Reverse Float Level Gauge

Atmospheric Storage Tank Options

Double Wall (SAFE) Atmospheric Storage Tank Options IPG V311

Options		
F20015	105 Gallon SAFE Tank, Seismic Restraint	\$ 2,468.01
F20016	160 Gallon SAFE Tank, Seismic Restraint	\$ 2,486.96
F20017	405 Gallon SAFE Tank, Seismic Restraint	\$ 2,496.43
F20018	540 Gallon SAFE Tank, Seismic Restraint	\$ 3,164.34
F20019	1000 Gallon SAFE Tank, Seismic Restraint	\$ 3,955.43
F20020	1550 Gallon SAFE Tank, Seismic Restraint	\$ 4,092.81
F20021	2500 Gallon SAFE Tank, Seismic Restraint	\$ 4,907.59
F20022	3150 Gallon SAFE Tank, Seismic Restraint	\$ 4,898.11
F20023	4400 Gallon SAFE Tank, Seismic Restraint	\$ 4,917.06
F20024	5400 Gallon SAFE Tank, Seismic Restraint	\$ 6,570.29
F20398	6550 Gallon SAFE Tank, Seismic Restraint	\$ 7,380.33
F20026	8700 Gallon SAFE Tank, Seismic Restraint	\$ 9,483.58
F20027	6' Ladder for 1000 Gallon Tank	\$ 3,912.81
F20028	7' Ladder for 1550 Gallon & 3150 Gallon Tank	\$ 4,205.39
F20029	10' Ladder for 2500 Gallon, 4400 Gallon, & 5400 Gallon Tank	\$ 3,979.12
F20399	14' Ladder for 6650 Gallon Tank	\$ 5,906.26
F20031	15' Ladder for 8700 Gallon Tank	\$ 6,202.75
F20032	Export Skid Packaging w/Heat Treated Skid	\$ 557.30

Single Wall Atmospheric Storage Tank Options IPG V312

Options		
105GVERTSEISMIC	105 Gallon Single Wall Tank, Seismic Restraint	\$ 3,285.04
155GVERTSEISMIC	155 Gallon Single Wall Tank, Seismic Restraint	\$ 2,700.89
205GVERTSEISMIC	205 Gallon Single Wall Tank, Seismic Restraint	\$ 2,512.46
300GVERTSEISMIC	300 Gallon Single Wall Tank, Seismic Restraint	\$ 2,700.89
400GVERTSEISMIC	400 Gallon Single Wall Tank, Seismic Restraint	\$ 2,707.18
540GVERTSEISMIC	540 Gallon Single Wall Tank, Seismic Restraint	\$ 2,857.93
615GVERTSEISMIC	615 Gallon Single Wall Tank, Seismic Restraint	\$ 2,726.03
755GVERTSEISMIC	755 Gallon Single Wall Tank, Seismic Restraint	\$ 3,800.11
805GVERTSEISMIC	805 Gallon Single Wall Tank, Seismic Restraint	\$ 4,692.03
905GVERTSEISMIC	905 Gallon Single Wall Tank, Seismic Restraint	\$ 3,818.94
1000GVERTSEISMIC	1000 Gallon Single Wall Tank, Seismic Restraint	\$ 3,800.11
1150GVERTSEISMIC	1150 Gallon Single Wall Tank, Seismic Restraint	\$ 3,844.07
905GVERTLAD	6' Ladder for 905 Gallon Tank	\$ 6,061.32
1150/3150GVERTLAD	8' Ladder for 1150 Gallon & 3150 Gallon Tank	\$ 7,009.78
F20399	14' Ladder for 6650 Gallon Tank	\$ 5,906.26
F20031	15' Ladder for 8700 Gallon Tank	\$ 6,202.75
F20032	Export Skid Packaging w/Heat Treated Skid	\$ 557.30

FOAMPAK2 - 60 Hz - SINGLE PUMP

MODEL	FOAM GPM	FOAM PSI	HP	PART NUMBER	LIST PRICE (IPG V310)
FP-15	45	100	7.5	F21950A	\$ 163,145.26
	40	150	10	F21951A	\$ 164,947.40
	35	200	15	F21952A	\$ 166,943.85
	30	261	20	F21953A	\$ 168,755.71
FP-30	55	100	10	F21954A	\$ 165,093.13
	50	150	15	F21955A	\$ 167,089.58
	45	200	15	F21956A	\$ 167,089.58
	40	261	20	F21957A	\$ 168,901.44
FP-50	70	100	15	F21958A	\$ 174,332.16
	65	150	20	F21959A	\$ 176,848.37
	60	200	20	F21960A	\$ 176,848.37
	55	261	25	F21961A	\$ 178,932.25
FP-75	110	100	20	F21962A	\$ 177,698.44
	105	150	25	F21963A	\$ 179,782.32
	100	200	40	F21964A	\$ 184,120.10
	90	261	40	F21965A	\$ 184,120.10
FP-100	150	100	25	F21966A	\$ 202,301.87
	140	150	30	F21967A	\$ 205,070.66
	130	200	40	F21968A	\$ 207,854.03
	120	261	40	F21969A	\$ 207,854.03
FP-150	180	100	25	F21970A	\$ 204,327.46
	170	150	30	F21971A	\$ 207,096.26
	160	200	40	F21972A	\$ 209,879.62
	150	261	50	F21973A	\$ 212,050.94
FP-175	235	100	40	F21974A	\$ 267,281.15
	220	150	50	F21975A	\$ 271,070.02
	200	200	60	F21976A	\$ 276,073.29
	185	261	75	F21977A	\$ 279,837.88
FP-200	250	100	40	F21978A	\$ 275,014.35
	240	150	60	F21979A	\$ 276,073.29
	220	200	75	F21980A	\$ 279,837.88
	200	261	75	F21981A	\$ 279,837.88
FP-225	300	100	40	F21982A	\$ 279,458.99
	280	150	60	F21983A	\$ 280,517.94
	260	200	75	F21984A	\$ 284,282.53
	240	261	75	F21985A	\$ 284,282.53
FP-250	315	100	50	F21986A	\$ 310,479.23
	290	150	60	F21987A	\$ 316,293.70
	270	200	75	F21988A	\$ 320,864.64
	250	261	100	F21989A	\$ 327,043.43
FP-350	420	100	60	F21990A	\$ 324,978.98
	400	150	75	F21991A	\$ 329,549.92
	390	200	100	F21992A	\$ 335,728.71
	380	250	125	F21993A	\$ 343,087.88

FOAMPAK2 - 60 Hz - DUAL PUMP

MODEL	FOAM GPM	FOAM PSI	HP	PART NUMBER	LIST PRICE (IPG V310)
FP-15	45	100	7.5	F21950AA	\$ 271,456.92
	40	150	10	F21951AA	\$ 271,456.92
	35	200	15	F21952AA	\$ 273,776.54
	30	261	20	F21953AA	\$ 275,792.69
FP-30	55	100	10	F21954AA	\$ 271,456.92
	50	150	15	F21955AA	\$ 273,776.54
	45	200	15	F21956AA	\$ 273,776.54
	40	261	20	F21957AA	\$ 275,792.69
FP-50	70	100	15	F21958AA	\$ 294,493.64
	65	150	20	F21959AA	\$ 296,489.24
	60	200	20	F21960AA	\$ 296,489.24
	55	261	25	F21961AA	\$ 298,947.71
FP-75	110	100	20	F21962AA	\$ 296,489.24
	105	150	25	F21963AA	\$ 298,947.71
	100	200	40	F21964AA	\$ 304,852.20
	90	261	40	F21965AA	\$ 304,852.20
FP-100	150	100	25	F21966AA	\$ 354,937.41
	140	150	30	F21967AA	\$ 357,200.45
	130	200	40	F21968AA	\$ 360,841.89
	120	261	40	F21969AA	\$ 360,841.89
FP-150	180	100	25	F21970AA	\$ 354,937.41
	170	150	30	F21971AA	\$ 357,200.45
	160	200	40	F21972AA	\$ 360,841.89
	150	261	50	F21973AA	\$ 363,120.37
FP-175	235	100	40	F21974AA	\$ 472,584.68
	220	150	50	F21975AA	\$ 474,919.73
	200	200	60	F21976AA	\$ 480,536.19
	185	261	75	F21977AA	\$ 485,484.02
FP-200	250	100	40	F21978AA	\$ 472,584.68
	240	150	60	F21979AA	\$ 480,536.19
	220	200	75	F21980AA	\$ 485,484.02
	200	261	75	F21981AA	\$ 485,484.02
FP-225	300	100	40	F21982AA	\$ 472,584.68
	280	150	60	F21983AA	\$ 480,536.19
	260	200	75	F21984AA	\$ 485,484.02
	240	261	75	F21985AA	\$ 485,484.02
FP-250	315	100	50	F21986AA	\$ 545,449.46
	290	150	60	F21987AA	\$ 551,122.50
	270	200	75	F21988AA	\$ 556,075.47
	250	261	100	F21989AA	\$ 571,402.43
FP-350	420	100	60	F21990AA	\$ 568,367.90
	400	150	75	F21991AA	\$ 573,320.87
	390	200	100	F21992AA	\$ 588,647.83
	380	250	125	F21993AA	\$ 592,597.87

60 Hz Foam Pump

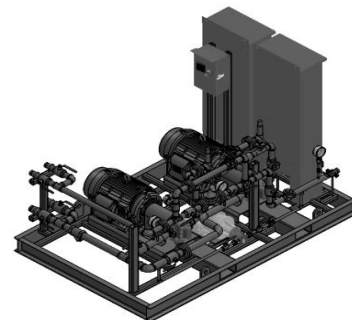
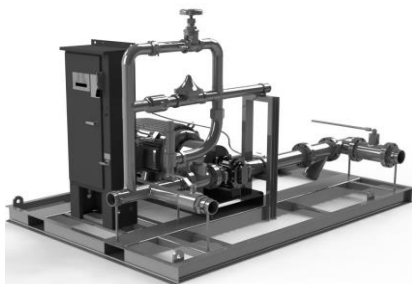

Fully Assembled Foam Pump Skid includes:

- Pump
- Pump Driver
- Pump Controller
- Casing Relief Valve
- Vacuum Gauge
- Pressure Gauge
- Duplex Gauge
- Pump Skid with Coupling Guard
- Panel Support Frame
- Suction Strainer
- UL/FM NamePlates
- Suction & Discharge Control Valve
- All Piping
- Assembled Piping Connections

FOAMPAK2 - 50 Hz - SINGLE PUMP

MODEL	FOAM LPM	FOAM PSI	KW	PART NUMBER	LIST PRICE (IPG V310)
FP-15	130	100	5	F21950B	\$ 163,145.26
	110	150	7	F21951B	\$ 164,757.96
	90	200	8	F21952B	\$ 168,668.28
	75	261	10.5	F21953B	\$ 170,577.29
FP-30	135	100	5	F21954B	\$ 164,903.68
	110	150	7.5	F21955B	\$ 172,612.60
	95	200	10	F21956B	\$ 172,612.60
	90	261	12	F21957B	\$ 176,333.47
FP-50	208	100	7.5	F21958B	\$ 175,959.44
	189	150	10	F21959B	\$ 178,679.66
	170	200	15	F21960B	\$ 178,679.66
	150	261	20	F21961B	\$ 181,268.73
FP-75	340	100	15	F21962B	\$ 182,045.93
	310	150	15	F21963B	\$ 186,718.89
	280	200	20	F21964B	\$ 196,662.26
	225	261	25	F21965B	\$ 196,662.26
FP-100	435	100	15	F21966B	\$ 211,482.61
	395	150	20	F21967B	\$ 210,593.68
	355	200	23	F21968B	\$ 217,010.49
	320	261	28	F21969B	\$ 217,010.49
FP-150	510	100	15	F21970B	\$ 212,211.24
	470	150	20	F21971B	\$ 212,619.28
	435	200	27	F21972B	\$ 219,036.08
	395	261	34	F21973B	\$ 225,346.02
FP-175	680	100	22.5	F21974B	\$ 270,885.44
	625	150	30	F21975B	\$ 275,621.54
	565	200	37.5	F21976B	\$ 284,734.28
	510	261	45	F21977B	\$ 289,907.56
FP-200	750	100	22.5	F21978B	\$ 278,618.64
	715	150	33.5	F21979B	\$ 292,467.48
	640	200	41	F21980B	\$ 297,640.76
	565	261	45	F21981B	\$ 297,640.76
FP-225	900	100	22.5	F21982B	\$ 283,063.29
	830	150	33.5	F21983B	\$ 296,912.12
	755	200	40	F21984B	\$ 302,085.40
	680	261	50	F21985B	\$ 302,085.40
FP-250	925	100	30	F21986B	\$ 315,210.47
	850	150	37.5	F21987B	\$ 326,572.25
	755	200	45	F21988B	\$ 332,882.19
	680	261	56	F21989B	\$ 344,302.26
FP-350	1230	100	37.5	F21990B	\$ 335,257.53
	1130	150	45	F21991B	\$ 341,567.47
	1095	200	56	F21992B	\$ 352,987.54
	1055	250	75	F21993B	\$ 354,201.92

FOAMPAK2 - 50 Hz - DUAL PUMP

MODEL	FOAM LPM	FOAM PSI	KW	PART NUMBER	LIST PRICE (IPG V310)
FP-15	130	100	5	F21950BB	\$ 271,456.92
	110	150	7	F21951BB	\$ 271,456.92
	90	200	8	F21952BB	\$ 273,776.54
	75	261	10.5	F21953BB	\$ 275,792.69
FP-30	135	100	5	F21954BB	\$ 271,456.92
	110	150	7.5	F21955BB	\$ 273,776.54
	95	200	10	F21956BB	\$ 273,776.54
	90	261	12	F21957BB	\$ 275,792.69
FP-50	208	100	7.5	F21958BB	\$ 294,493.64
	189	150	10	F21959BB	\$ 296,489.24
	170	200	15	F21960BB	\$ 296,489.24
	150	261	20	F21961BB	\$ 298,947.71
FP-75	340	100	15	F21962BB	\$ 296,489.24
	310	150	15	F21963BB	\$ 298,947.71
	280	200	20	F21964BB	\$ 304,852.20
	225	261	25	F21965BB	\$ 304,852.20
FP-100	435	100	15	F21966BB	\$ 354,937.41
	395	150	20	F21967BB	\$ 357,200.45
	355	200	23	F21968BB	\$ 360,841.89
	320	261	28	F21969BB	\$ 360,841.89
FP-150	510	100	15	F21970BB	\$ 354,937.41
	470	150	20	F21971BB	\$ 357,200.45
	435	200	27	F21972BB	\$ 360,841.89
	395	261	34	F21973BB	\$ 363,120.37
FP-175	680	100	22.5	F21974BB	\$ 472,584.68
	625	150	30	F21975BB	\$ 474,919.73
	565	200	37.5	F21976BB	\$ 480,536.19
	510	261	45	F21977BB	\$ 485,484.02
FP-200	750	100	22.5	F21978BB	\$ 472,584.68
	715	150	33.5	F21979BB	\$ 480,536.19
	640	200	41	F21980BB	\$ 485,484.02
	565	261	45	F21981BB	\$ 485,484.02
FP-225	900	100	22.5	F21982BB	\$ 472,584.68
	830	150	33.5	F21983BB	\$ 480,536.19
	755	200	40	F21984BB	\$ 485,484.02
	680	261	50	F21985BB	\$ 485,484.02
FP-250	925	100	30	F21986BB	\$ 545,449.46
	850	150	37.5	F21987BB	\$ 551,122.50
	755	200	45	F21988BB	\$ 556,075.47
	680	261	56	F21989BB	\$ 571,402.43
FP-350	1230	100	37.5	F21990BB	\$ 568,367.90
	1130	150	45	F21991BB	\$ 573,320.87
	1095	200	56	F21992BB	\$ 588,647.83
	1055	250	75	F21993BB	\$ 592,597.87

50 Hz Foam Pump

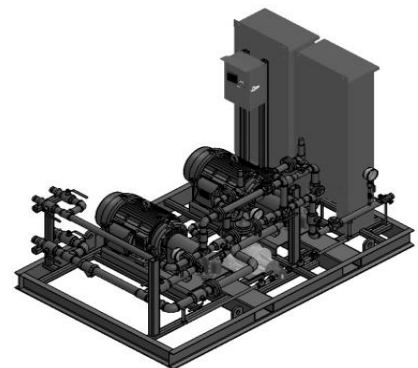
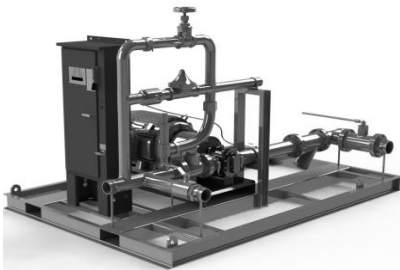

Fully Assembled Foam Pump Skid includes:

- Pump
- Pump Driver
- Pump Controller
- Casing Relief Valve
- Vacuum Gauge
- Pressure Gauge
- Duplex Gauge
- Pump Skid with Coupling Guard
- Panel Support Frame
- Suction Strainer
- UL/FM NamePlates
- Suction & Discharge Control Valve
- All Piping
- Assembled Piping Connections

FOAMPAK FOAM PUMP SYSTEM Optional Equipment	ADD TO LIST PRICE (each)
When Ordering Non-Standard FoamPak, Specify the following suffixes:	
PUMP MOTORS M = IEEE841, ATEX (IP65) Certified for Zone 2	POR
PUMP VOLTAGE V1 = 200/208V V2 = 220/230V V3 = 380/415V V4 = 575V V5 = Diesel Engine	N/C N/C N/C POR POR
NEMA RATING NEMA Rating N = NEMA 4X	\$ 18,559.83
CONTROLLER TRANSFER SWITCH S = Transfer Switch	POR
CONTROLLER STARTING METHOD F = Mercoid Switch Pressure Drop	\$ 1,918.90

FOAMPAK FOAM PUMP SYSTEM Optional Equipment	ADD TO LIST PRICE (each)
When Ordering Non-Standard FoamPak, Specify the following suffixes:	
EXTRA CONTACTS E1 = 1 Contact E2 = 2 Contacts E3 = 3 Contacts	\$ 283.12 \$ 566.23 \$ 849.35
ANTI-CONDENSATION SPACE HEATER FOR CONTROLLER H1 = 120V 1 Phase H2 = 240V 1 Phase	\$ 1,006.64 \$ 1,006.64
TESTING Standard Testing, Water Complete FoamPak Piping Hydro Test w/Report T1 = Witnessed Pump Test, Water only	\$ 2,336.83
Special Testing/Documentation T2 = Pump Only Testing w/Foam Concentrate T3 = Witnessed Pump Testing w/Foam Concentrate T4 = Material Certificates T5 = Witnessed Hydro Testing	POR POR POR POR

PART NUMBER DESCRIPTION AND OPTIONS

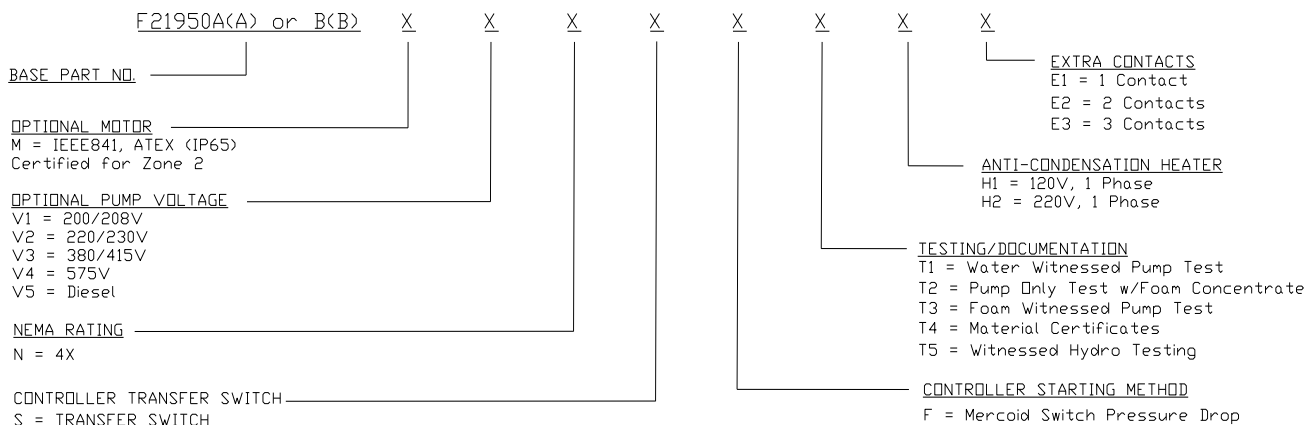

EXAMPLE: F21950AANST1T4

45 GPM @ 100 PSI 7.5HP 60 Hz Dual Pump Skid
with NEMA 4X Enclosure, Transfer Switch and Material Certificates

Base part number indicates flow, pressure, single or dual pump skid.
460/480V Controller and NEMA 2 Enclosure are standard equipment.
60 Hz Pump Motors are in IP-45/DDP and 50 Hz Pump Motors are in IP-55/TEFC as standard

High Expansion Foam Systems

3% XMAX High Expansion Foam Concentrate IPG V300



Part Number	Description	Gallons/Container	Shipping Weight*	List Price*
F23508-6.5	XMAX 3% Foam Concentrate	6.5 gal can	62 lbs.	\$ 399.26
F23508-55	XMAX 3% Foam Concentrate	55 gal drum	488 lbs.	\$ 3,378.38
F23508-265	XMAX 3% Foam Concentrate	265 gal IBC tote	2393 lbs.	\$ 16,277.64

*Per container

Model VGH10000 High Expansion Foam Generator IPG V313

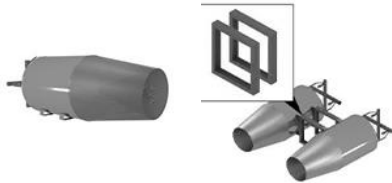

Part Number	Description	List Price
F23772	VGH10000 High Expansion Foam Generator	\$ 17,962.67
F23777	VGH10000 Pairing Bracket Kit	\$ 2,668.74

High Expansion Foam Ratio Controllers IPG V302



Part Number	Description	List Price
F20152N	3" Ratio Controller - XMAX	\$ 2,808.08
F20217N	4" Ratio Controller - XMAX	\$ 3,255.35
F20214N	6" Ratio Controller - XMAX	\$ 4,690.13
F20137N	8" Ratio Controller - XMAX	\$ 7,727.39

High Expansion Foam ILBP IPG V303



Part Number	Description	List Price
F20316N	3" ILBP - XMAX	\$ 16,096.31
F20317N	4" ILBP - XMAX	\$ 17,206.40
F20184N	6" ILBP - XMAX	\$ 19,704.10
F20185N	8" ILBP - XMAX	\$ 21,646.75