



TECHNICAL DATA

EC/QREC ORDINARY HAZARD PENDENT SPRINKLER VK572 (K14.0)

The Viking Corporation, 210 N Industrial Park Drive, Hastings MI 49058

Telephone: 269-945-9501 Technical Services: 877-384-5464 Fax: 269-818-1680 Email: techsvcs@vikingcorp.com

Visit the Viking website for the latest edition of this technical data page www.vikinggroupinc.com

1. DESCRIPTION

Viking Standard/Quick Response Extended Coverage Ordinary Hazard (ECOH) Pendent Sprinkler VK572 is a thermosensitive glass bulb spray sprinkler with a 14.0 (202 metric*) nominal K-Factor. The sprinkler produces the flows required to meet Ordinary Hazard density requirements at lower pressures than 8.0 or 11.2 (115.2 or 161.4 metric*) K-Factor sprinklers. The glass bulb operating element and special deflector characteristics meet the challenges of quick response extended coverage standards. Viking EC/QREC Ordinary Hazard Sprinklers are available in various finishes and temperature ratings to meet design requirements. The special Polyester coatings can be used in decorative applications where colors are desired. In addition, the ENT coating has been investigated for installation in corrosive environments and is listed as indicated in the Approval Charts. The Viking VK572 Sprinkler may be ordered and/or used as an open sprinkler (glass bulb and pip-cap assembly removed) on deluge systems. Refer to Ordering Instructions on the next page.

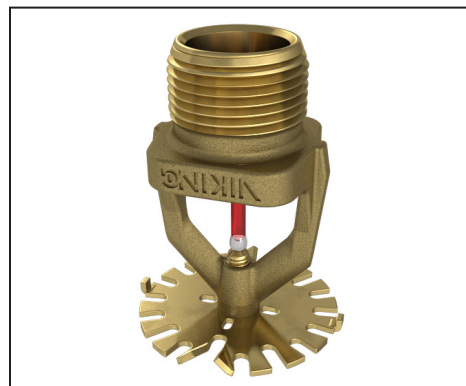

NOTE: As of May 2018 all logos have been removed from the wrench boss.

2. LISTINGS AND APPROVALS



cULus Listed: Category VNIV



FM Approved: Class 2022

NYC Approved: MEA 89-92-E, Volume 38

Refer to Approval Chart 1 and Design Criteria for cULus Listing requirements and refer to Approval Chart 2 and Design Criteria for FM Approval requirements that must be followed.



WARNING: Cancer and Reproductive Harm-
www.P65Warnings.ca.gov

3. TECHNICAL DATA

Specifications:

Available since 2004.

Minimum Operating Pressure: Refer to the Approval Charts.

Maximum Working Pressure: 175 psi (12 bar). Factory tested hydrostatically to 500 psi (34.5 bar).

Thread size: 3/4" (20 mm) NPT

Nominal K-Factor: 14.0 U.S. (202 metric*)

* Metric K-factor measurement shown is in Bar. When pressure is measured in kPa, divide the metric K-factor shown by 10.0.

Glass-bulb fluid temperature rated to -65 °F (-55 °C)

Overall Length: 2-7/16" (62 mm)

Material Standards:

Sprinkler Frame: Brass UNS-C84400

Deflector: Phosphor Bronze UNS-C51000

Bulb: Glass, nominal 3 mm diameter

Pip Cap: Brass UNS-C31400 or UNS-C31600

Compression Screw: Brass UNS-C36000

Belleville Spring Sealing Assembly: Nickel Alloy, coated on both sides with PTFE Tape

For ENT coated Sprinklers: Belleville Spring - Exposed, Screw and Pipcap - ENT plated.

For Polyester Coated Sprinklers: Belleville Spring-Exposed

Ordering Information: (Also refer to the current Viking price list.)

Order EC/QREC Ordinary Hazard Pendent Sprinkler VK572 by first adding the appropriate suffix for the sprinkler finish and then the appropriate suffix for the temperature rating to the sprinkler base part number.

Finish Suffix: Brass = A, Chrome = F, White Polyester = M-/W, Black Polyester = M-/B, and ENT = JN

Temperature Suffix (°F/°C): 155°/68° = B, 175°/79° = D, 200°/93° = E, and 286°/141° = G, OPEN = Z (PTFE only).

For example, sprinkler VK572 with a Brass finish and a 155 °F/68 °C temperature rating = Part No. 13722AB.

Available Finishes And Temperature Ratings: Refer to Table 1.



TECHNICAL DATA

**EC/QREC ORDINARY
HAZARD PENDENT
SPRINKLER VK572 (K14.0)**

The Viking Corporation, 210 N Industrial Park Drive, Hastings MI 49058

Telephone: 269-945-9501 Technical Services: 877-384-5464 Fax: 269-818-1680 Email: techsvcs@vikingcorp.com

Visit the Viking website for the latest edition of this technical data page www.vikinggroupinc.com

Accessories: (Also refer to the Viking website.)

Sprinkler Wrenches:

- A. Standard Wrench: Part No. 07297W/B (available since 1991)
 - B. Wrench for coated and/or recessed pendent sprinkler: Part No. 13032W/B** (available since 2004)
- **A 1/2" ratchet is required (not available from Viking).

Sprinkler Cabinets:

- A. Six-head capacity: Part No. 01724A (available since 1971)
- B. Twelve-head capacity: Part No. 01725A (available since 1971)

4. INSTALLATION

Refer to appropriate NFPA Installation Standards.

5. OPERATION

During fire conditions, when the temperature around the sprinkler reaches its operating temperature, the heat-sensitive liquid in the glass bulb expands, causing the bulb to shatter, releasing the pip cap and sealing spring assembly. Water flowing through the sprinkler orifice strikes the sprinkler deflector, forming a uniform spray pattern to extinguish or control the fire.

6. INSPECTIONS, TESTS AND MAINTENANCE

Refer to NFPA 25 for Inspection, Testing and Maintenance requirements

7. AVAILABILITY

The Viking Model VK572 Sprinkler is available through a network of domestic and international distributors. See The Viking Corporation web site for the closest distributor or contact The Viking Corporation.

8. GUARANTEE

For details of warranty, refer to Viking's current list price schedule or contact Viking directly.

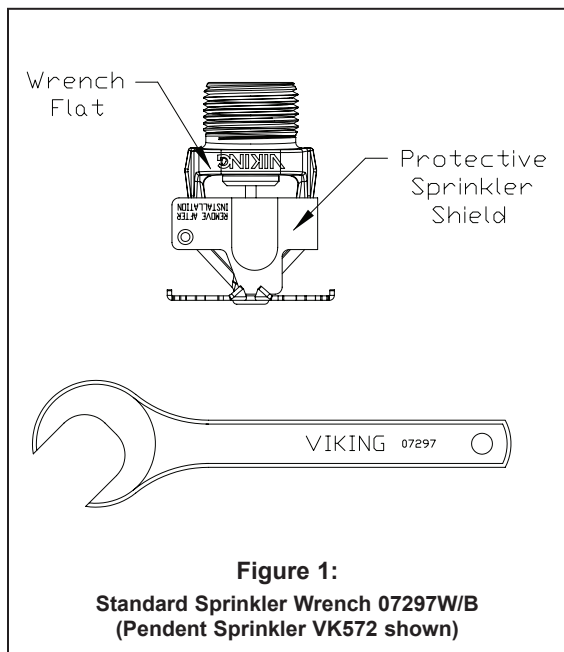

Figure 1:
Standard Sprinkler Wrench 07297W/B
(Pendent Sprinkler VK572 shown)

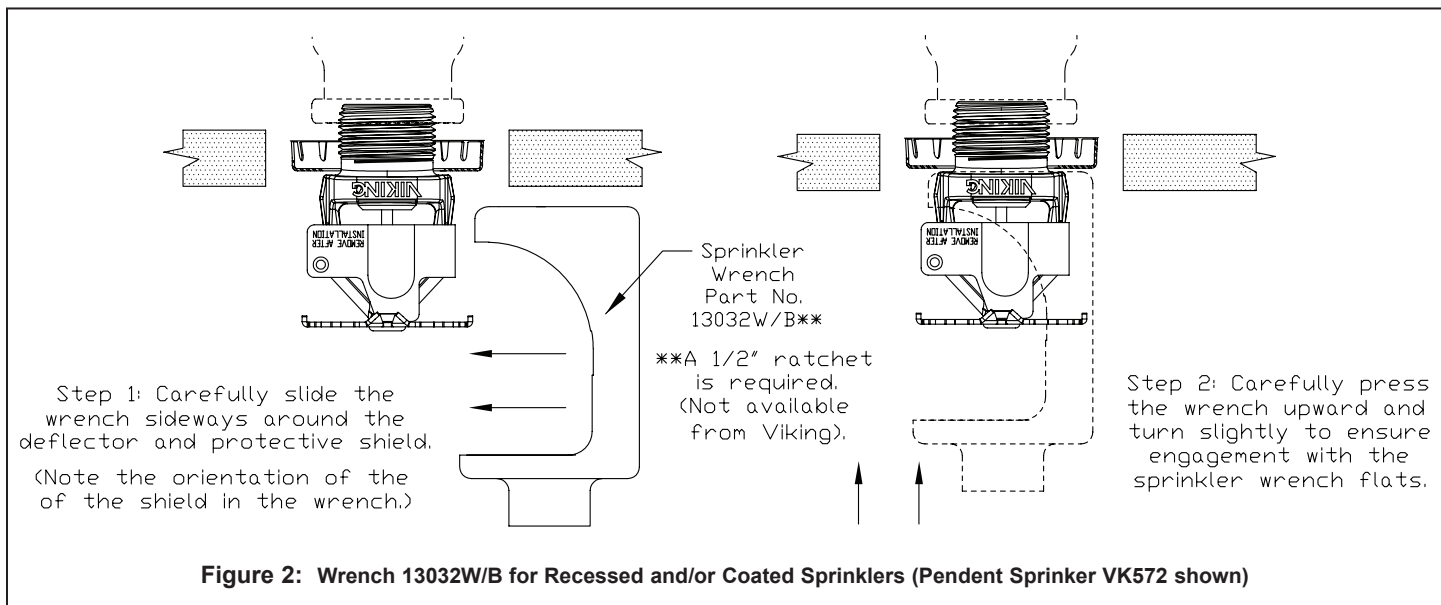

Figure 2: Wrench 13032W/B for Recessed and/or Coated Sprinklers (Pendent Sprinkler VK572 shown)



TECHNICAL DATA

**EC/QREC ORDINARY
HAZARD PENDING
SPRINKLER VK572 (K14.0)**

The Viking Corporation, 210 N Industrial Park Drive, Hastings MI 49058
 Telephone: 269-945-9501 Technical Services: 877-384-5464 Fax: 269-818-1680 Email: techsvcs@vikingcorp.com
 Visit the Viking website for the latest edition of this technical data page www.vikinggroupinc.com

TABLE 1: AVAILABLE SPRINKLER TEMPERATURE RATINGS AND FINISHES

Sprinkler Temperature Classification	Sprinkler Nominal Temperature Rating ¹	Maximum Ambient Ceiling Temperature ²	Bulb Color
Ordinary	155 °F (68 °C)	100 °F (38 °C)	Red
Intermediate	175 °F (79 °C)	150 °F (65 °C)	Yellow
Intermediate	200 °F (93 °C)	150 °F (65 °C)	Green
High	286 °F (141 °C)	225 °F (107 °C)	Blue

Available Sprinkler Finishes: Brass, Chrome, White Polyester³, Black Polyester³, and ENT³

Corrosion Resistant/Proofing Sprinkler Finishes: ENT³

Footnotes

- ¹ The sprinkler temperature rating is stamped on the deflector.
- ² Based on NFPA-13. Other limits may apply, depending on fire loading, sprinkler location, and other requirements of the Authority Having Jurisdiction. Refer to specific installation standards.
- ³ The corrosion-resistant coatings have passed the standard corrosion test required by the approving agencies indicated in the Approval Charts. These tests cannot and do not represent all possible corrosive environments. Prior to installation, verify through the end-user that the coatings are compatible with or suitable for the proposed environment. For automatic sprinklers, the coatings indicated are applied to the exposed exterior surfaces only. Note that the spring is exposed on sprinklers with Polyester and ENT. For ENT coated automatic sprinklers, the waterway is coated.

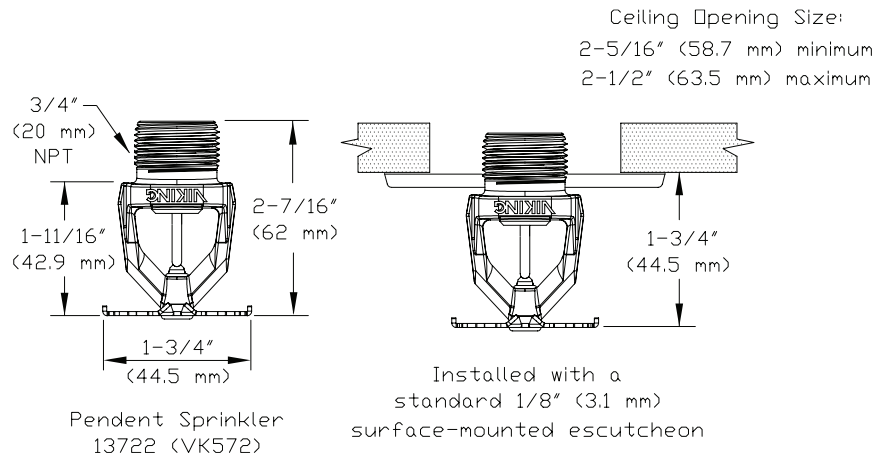

Figure 3: Pendent Sprinkler VK572 Dimensions with a Standard Escutcheon



TECHNICAL DATA

EC/QREC ORDINARY HAZARD PENDENT SPRINKLER VK572 (K14.0)

The Viking Corporation, 210 N Industrial Park Drive, Hastings MI 49058

Telephone: 269-945-9501 Technical Services: 877-384-5464 Fax: 269-818-1680 Email: techsvcs@vikingcorp.com

Visit the Viking website for the latest edition of this technical data page www.vikinggroupinc.com

Approval Chart 1 (UL)								
Standard/Quick Response Extended Coverage Ordinary Hazard Pendent Sprinkler VK572 (K14.0)								
Sprinkler Base Part Number ¹	SIN	NPT Thread Size		Nominal K-Factor		Maximum Water Working Pressure	Overall Length	
		Inches	mm	U.S.	metric ²		Inches	mm
13722 Pendent	VK572	3/4	20	14.0	202	175 psi (12 bar)	2-7/16	62
Maximum Sprinkler Spacing L x W ⁵	Maximum Area per Sprinkler	Minimum Water Supply Requirements (cULus only)					cULus/NYC Listings ^{3,4,7} (See Design Criteria)	
		Ordinary Hazard Group I			Ordinary Hazard Group II			
		Flow / Pressure			Flow / Pressure			
Standard Response							Pendent VK572	
16 ft. x 16 ft. (4.9 m x 4.9 m)	256 ft ² (23.8 m ²)	39 gpm @ 7.8 psi (147.6 l/min @ 0.54 bar)			51 gpm @ 13.3 psi (193.1 l/min @ 0.92 bar)		A1X, B1Y	
18 ft. x 18 ft. (5.5 m x 5.5 m)	324 ft ² (30.1 m ²)	49 gpm @ 12.3 psi (185.5 l/min @ 0.85 bar)			65 gpm @ 21.6 psi (246.1 l/min @ 1.49 bar)		A1X, B1Y	
20 ft. x 20 ft. (6.1 m x 6.1 m)	400 ft ² (37.2 m ²)	60 gpm @ 18.4 psi (227.1 l/min @ 1.27 bar)			80 gpm @ 32.7 psi (302.8 l/min @ 2.25 bar)		A1X, B1Y	
Quick Response ^{6, 8}								
12 ft. x 12 ft. (3.7 m x 3.7 m)	144 ft ² (13.4 m ²)	39 gpm @ 7.8 psi (147.6 l/min @ 0.54 bar)			39 gpm @ 7.8 psi (147.6 l/min @ 0.54 bar)		A1X, B1Y	
14 ft. x 14 ft. (4.3 m x 4.3 m)	196 ft ² (18.2 m ²)	39 gpm @ 7.8 psi (147.6 l/min @ 0.54 bar)			39 gpm @ 7.8 psi (147.6 l/min @ 0.54 bar)		A1X, B1Y	
Approved Temperature Ratings		Approved Finishes			Approved Escutcheons			
A - 155 °F (68 °C), 175 °F (79 °C), 200 °F (93 °C), and 286 °F (141 °C) ⁶ B - 155 °F (68 °C), 175 °F (79 °C), and 200 °F (93 °C)		1 - Brass, Chrome, White Polyester, Black Polyester, and ENT ⁹			X - Standard surface-mounted escutcheons Y - Standard surface-mounted escutcheons or recessed with the Micromatic [®] Model E-1 or E-2 Recessed Escutcheon			
Footnotes								
¹ Part number shown is the base part number. For complete part number, refer to current Viking price list schedule.								
² Metric K-factor measurement shown is when pressure is measured in Bar. When pressure is measured in kPa, divide the metric K-factor shown by 10.0.								
³ This chart shows listings and approvals available at time of printing. Other approvals may be in process. Check with the manufacturer for any additional approvals.								
⁴ cULus Listed for use in the U.S. and Canada.								
⁵ To determine "Minimum Water Supply Requirement" for areas of coverage where length and width of actual sprinkler spacing are not equal, select the "Maximum Sprinkler Spacing" from the chart that is equal to or greater than the larger of the actual spacing (length or width) dimensions used. Example: When using 10 ft 6 in x 13 ft (3.2 m x 4 m) sprinkler spacing, provide the "Minimum Water Supply Requirement" listed in the chart for 14 ft x 14 ft (4.3 m x 4.3 m) spacing. For areas of coverage smaller than shown, use the "Minimum Water Supply Requirement" in the appropriate hazard group for the next larger area listed. The distance from sprinklers to walls shall not exceed one-half the "Maximum Sprinkler Spacing" listed for the "Minimum Water Supply Requirement" used.								
⁶ For Sprinkler VK572 with High Temperature 286 °F rating, UL restricts the QR listing to their use in Ordinary Hazard occupancies to the high temperature zones within a building only. VK572 quick response sprinklers with this temperature rating cannot be used throughout the property.								
⁷ Accepted for use, City of New York Department of Buildings, MEA Number 89-92-E, Vol. 38.								
⁸ Prior to 2007, sprinkler VK572 was classified as Standard Response for all room sizes.								
⁹ cULus Listed as corrosion resistant.								



TECHNICAL DATA

EC/QREC ORDINARY HAZARD PENDENT SPRINKLER VK572 (K14.0)

The Viking Corporation, 210 N Industrial Park Drive, Hastings MI 49058

Telephone: 269-945-9501 Technical Services: 877-384-5464 Fax: 269-818-1680 Email: techsvcs@vikingcorp.com

Visit the Viking website for the latest edition of this technical data page www.vikinggroupinc.com

DESIGN CRITERIA - UL

(Also refer to Approval Chart 1.)

cULus Listing Requirements: ECOH Pendent Sprinkler VK572 is cULus Listed as Standard and Quick Response for installation in accordance with the latest edition of NFPA 13 for extended coverage pendent spray sprinklers as indicated below:

- The minimum water supplies and maximum areas of coverage shown in Approval Chart 1 are designed to provide the following design densities: 0.15 gpm/ft² (6.1 mm/min) for Ordinary-Hazard Group I densities; 0.2 gpm/ft.² (8.1 mm/min) for Ordinary-Hazard Group II densities.
- The sprinkler installation rules contained in NFPA 13 for extended coverage pendent spray sprinklers must be followed with the exception that cULus Listing requires the spacing between Viking ECOH Pendent Sprinklers to be a minimum of **9 ft. (2.75 m)** to prevent cold soldering.
- Viking ECOH Pendent Sprinklers are cULus Listed for use in unobstructed construction, and noncombustible obstructed construction consisting of solid steel and/or concrete beams as defined in the latest edition of NFPA 13.
- Ceiling slope not to exceed 2/12 (9.5°).
- Venting is not required.

Also, Viking ECOH Pendent Sprinkler VK572 is specifically cULus Listed for:

- For non-combustible obstructed construction within trusses or bar joists having non-combustible web members greater than 1" (25.4 mm) when applying the 4 times obstruction criteria rule as defined in NFPA 13 under "Obstructions to Sprinkler Discharge Pattern Development".
- For installation under concrete tees when installed as follows:
 1. The stems of the concrete tee construction must be spaced between 3 ft (0.9 m) and 7 ft-6 in (2.3 m) on center. The depth of the concrete tees must not exceed 30 in (762 mm). The maximum permitted concrete tee length is 32 ft (9.8 m). However, where the concrete tee length exceeds 32 ft (9.8 m), non-combustible baffles, equal in height to the depth of the tees, can be installed so that the space between the tees does not exceed 32 ft (9.8 m).
 2. The sprinkler deflector is to be located in a horizontal plane at or above 1" (25.4 mm) below the bottom of the concrete tee stems.

IMPORTANT: Always refer to Bulletin Form No. F_091699 - Care and Handling of Sprinklers. Also refer to Form No. 080614 for general care, installation, and maintenance information. Viking sprinklers are to be installed in accordance with the latest edition of Viking technical data, the appropriate standards of NFPA, FM Global, LPCB, APSAD, VdS or other similar organizations, and also with the provisions of governmental codes, ordinances, and standards, whenever applicable.



TECHNICAL DATA

EC/QREC ORDINARY HAZARD PENDENT SPRINKLER VK572 (K14.0)

The Viking Corporation, 210 N Industrial Park Drive, Hastings MI 49058

Telephone: 269-945-9501 Technical Services: 877-384-5464 Fax: 269-818-1680 Email: techsvcs@vikingcorp.com

Visit the Viking website for the latest edition of this technical data page www.vikinggroupinc.com

Approval Chart 2 (FM)

Quick Response Extended Coverage Pendent Sprinkler VK572 (K14.0)
For HC-1, HC-2, and HC-3 Occupancies

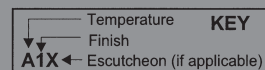

Sprinkler Base Part Number ¹	SIN	NPT Thread Size		Nominal K-Factor		Maximum Water Working Pressure	Overall Length	
		Inches	mm	U.S.	metric ²		Inches	mm
13722	VK572	3/4	20	14.0	202	175 psi (12 bar)	2-7/16	62
Maximum Sprinkler Spacing L x W ⁴		Maximum Area per Sprinkler		Refer to Design Criteria below. NOTE: FM installation guidelines may differ from cULus and/or NFPA criteria. Refer to the latest applicable FM Loss Prevention Data Sheets (including 2-0 and 3-26).			FM Approvals ³ Pendent Sprinkler VK572	
12 ft. x 12 ft. (3.7 m x 3.7 m)		144 ft ² (13.4 m ²)					A1X	
14 ft. x 14 ft. (4.3 m x 4.3 m)		196 ft ² (18.2 m ²)					A1X	
16 ft. x 16 ft. (4.9 m x 4.9 m)		256 ft ² (23.8 m ²)					A1X	
18 ft. x 18 ft. (5.5 m x 5.5 m)		324 ft ² (30.1 m ²)					A1X	
20 ft. x 20 ft. (6.1 m x 6.1 m)		400 ft ² (37.2 m ²)					A1X	
Approved Temperature Ratings				Approved Finish		Approved Escutcheons		
A - 155 °F (68 °C), 175 °F (79 °C), 200 °F (93 °C), and 286 °F (141 °C) ⁶				1 - Brass		X - Standard surface-mounted escutcheons		

Footnotes

- Part number shown is the base part number. For complete part number, refer to current Viking price list schedule.
- Metric K-factor measurement shown is when pressure is measured in Bar. When pressure is measured in kPa, divide the metric K-factor shown by 10.0.
- This chart shows the FM Approvals available at time of printing. Other approvals may be in process. Check with the manufacturer for any additional approvals.
- To determine "Minimum Water Supply Requirement" for areas of coverage where length and width of actual sprinkler spacing are not equal, select the "Maximum Sprinkler Spacing" from the chart that is equal to or greater than the larger of the actual spacing (length or width) dimensions used. Example: When using 10 ft 6 in x 13 ft (3.2 m x 4 m) sprinkler spacing, provide the "Minimum Water Supply Requirement" listed in the chart for 14 ft x 14 ft (4.3 m x 4.3 m) spacing. For areas of coverage smaller than shown, use the "Minimum Water Supply Requirement" in the appropriate hazard group for the next larger area listed. The distance from sprinklers to walls shall not exceed one-half the "Maximum Sprinkler Spacing" listed for the "Minimum Water Supply Requirement" used.

DESIGN CRITERIA - FM

(Also refer to Approval Chart 2 above.)

FM Approval Requirements:

Sprinkler VK572 is FM Approved as a quick response **Non-Storage** extended coverage pendent sprinkler as indicated in the FM Approval Guide for use in occupancy hazard classifications HC-1, HC-2, and HC-3. For specific application and installation requirements, reference the latest applicable FM Loss Prevention Data Sheets (including Data Sheet 2-0 and 3-26). FM Global Loss Prevention Data Sheets contain guidelines relating to, but not limited to: minimum water supply requirements, hydraulic design, ceiling slope and obstructions, minimum and maximum allowable spacing, and deflector distance below the ceiling.

NOTE: The FM installation guidelines may differ from cULus and/or NFPA criteria.

IMPORTANT: Always refer to Bulletin Form No. F_091699 - Care and Handling of Sprinklers. Also refer to Form No. 080614 for general care, installation, and maintenance information. Viking sprinklers are to be installed in accordance with the latest edition of Viking technical data, the appropriate standards of NFPA, FM Global, LPCB, APSAD, VdS or other similar organizations, and also with the provisions of governmental codes, ordinances, and standards, whenever applicable.



BULLETIN

CARE AND HANDLING
OF SPRINKLERS

The Viking Corporation, 210 N Industrial Park Drive, Hastings MI 49058
 Telephone: 269-945-9501 Technical Services: 877-384-5464 Fax: 269-818-1680 Email: techsvcs@vikingcorp.com

SPRINKLERS ARE FRAGILE - HANDLE WITH CARE!

General Handling and Storage:

- Store sprinklers in a cool, dry place.
- Protect sprinklers during storage, transport, handling, and after installation.
- Use the original shipping containers. DO NOT place sprinklers loose in boxes, bins, or buckets.
- Keep sprinklers separated at all times. DO NOT allow metal parts to contact sprinkler operating elements.

For Pre-Assembled Drops:

- Protect sprinklers during handling and after installation.
- For recessed assemblies, use the protective sprinkler cap (Viking Part Number 10364).

Sprinklers with Protective Shields or Caps:

- DO NOT remove shields or caps until after sprinkler installation and there no longer is potential for mechanical damage to the sprinkler operating elements.
- **Sprinkler shields or caps MUST be removed BEFORE placing the system in service!**
- Remove the sprinkler shield by carefully pulling it apart where it is snapped together.
- Remove the cap by turning it slightly and pulling it off the sprinkler.

Sprinkler Installation:

- DO NOT use the sprinkler deflector or operating element to start or thread the sprinkler into a fitting.
- **Use only the designated sprinkler head wrench!** Refer to the current sprinkler technical data page to determine the correct wrench for the model of sprinkler used.
- DO NOT install sprinklers onto piping at the floor level.
- Install sprinklers after the piping is in place to prevent mechanical damage.
- DO NOT allow impacts such as hammer blows directly to sprinklers or to fittings, pipe, or couplings in close proximity to sprinklers. Sprinklers can be damaged from direct or indirect impacts.
- DO NOT attempt to remove drywall, paint, etc., from sprinklers.
- **Take care not to over-tighten the sprinkler and/or damage its operating parts!**

Maximum Torque:

1/2" NPT: 14 ft-lbs. (19.0 N-m)

3/4" NPT: 20 ft-lbs. (27.1 N-m)

1" NPT: 30 ft-lbs. (40.7 N-m)



CORRECT
(Original container used)

INCORRECT
(Placed loose in box)

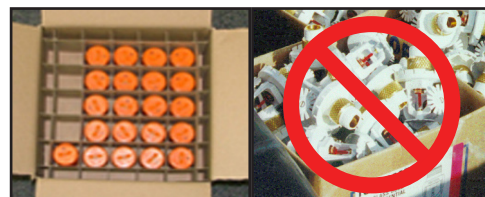

CORRECT
(Protected with caps)

INCORRECT
(Protective caps not used)



CORRECT
(Piping is in place at the ceiling)

INCORRECT
(Sprinkler at floor level)



CORRECT
(Special installation wrenches)

INCORRECT
(Designated wrench not used)



WARNING: Cancer and Reproductive Harm-
www.P65Warnings.ca.gov

! WARNING

Any sprinkler with a loss of liquid from the glass bulb or damage to the fusible element should be destroyed. Never install sprinklers that have been dropped, damaged, or exposed to temperatures exceeding the maximum ambient temperature allowed. Sprinklers that have been painted in the field must be replaced per NFPA 13. Protect sprinklers from paint and paint overspray in accordance with the installation standards. Do not clean sprinklers with soap and water, ammonia, or any other cleaning fluid. Do not use adhesives or solvents on sprinklers or their operating elements.

Refer to the appropriate technical data page and NFPA standards for complete care, handling, installation, and maintenance instructions. For additional product and system information Viking data pages and installation instructions are available on the Viking Web site at www.vikinggroupinc.com.



BULLETIN

CARE AND HANDLING
OF SPRINKLERS

The Viking Corporation, 210 N Industrial Park Drive, Hastings MI 49058
 Telephone: 269-945-9501 Technical Services: 877-384-5464 Fax: 269-818-1680 Email: techsvcs@vikingcorp.com

PROTECTIVE SPRINKLER SHIELDS AND CAPS

General Handling and Storage:

Many Viking sprinklers are available with a plastic protective cap or shield temporarily covering the operating elements. The snap-on shields and caps are factory installed and are intended to help protect the operating elements from mechanical damage during shipping, storage, and installation. NOTE: It is still necessary to follow the care and handling instructions on the appropriate sprinkler technical data sheets* when installing sprinklers with bulb shields or caps.

WHEN TO REMOVE THE SHIELDS AND CAPS:

NOTE: SHIELDS AND CAPS MUST BE REMOVED FROM SPRINKLERS BEFORE PLACING THE SYSTEM IN SERVICE!

Remove the shield or cap from the sprinkler only after checking all of the following:

- The sprinkler has been installed*.
- The wall or ceiling finish work is completed where the sprinkler is installed and there no longer is a potential for mechanical damage to the sprinkler operating elements.

SHIELDS AND CAPS MUST BE REMOVED FROM SPRINKLERS BEFORE PLACING THE SYSTEM IN SERVICE!

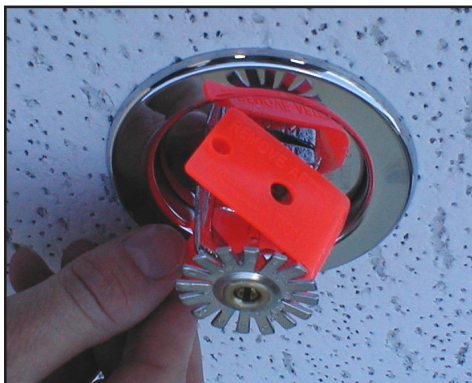

Figure 1: Sprinkler shield being removed from a pendent sprinkler.



Figure 2: Sprinkler cap being removed from a pendent sprinkler.



Figure 3: Sprinkler cap being removed from an upright sprinkler.

HOW TO REMOVE SHIELDS AND CAPS:

No tools are necessary to remove the shields or caps from sprinklers. DO NOT use any sharp objects to remove them! **Take care not to cause mechanical damage to sprinklers when removing the shields or caps.** When removing caps from fusible element sprinklers, use care to prevent dislodging ejector springs or damaging fusible elements. NOTE: Squeezing the sprinkler cap excessively could damage sprinkler fusible elements.

- To remove the shield, simply pull the ends of the shield apart where it is snapped together. Refer to Figure 1.
- To remove the cap, turn it slightly and pull it off the sprinkler. Refer to Figures 2 and 3.

NOTICE

Refer to the current sprinkler technical data page to determine the correct sprinkler wrench for the model of sprinkler used.

WARNING

Never install sprinklers that have been dropped, damaged, or exposed to temperatures in excess of the maximum ambient temperature allowed.

* Refer to the appropriate current technical data pages for complete care, handling, and installation instructions. Data pages are included with each shipment from Viking or Viking distributors. They can also be found on the Web site at www.vikinggroupinc.com.



BULLETIN

CARE AND HANDLING
OF SPRINKLERS

The Viking Corporation, 210 N Industrial Park Drive, Hastings MI 49058
 Telephone: 269-945-9501 Technical Services: 877-384-5464 Fax: 269-818-1680 Email: techsvcs@vikingcorp.com



CONCEALED COVER ASSEMBLIES ARE FRAGILE!
TO ASSURE SATISFACTORY PERFORMANCE OF THE PRODUCT, HANDLE WITH CARE.



Concealed Sprinkler and Adapter
 Assembly with Protective Cap

Concealed Sprinkler and Adapter
 Assembly (Protective Cap Removed)



Cover Plate Assembly
 (Pendent Cover 12381 shown)



GENERAL HANDLING AND STORAGE INSTRUCTIONS:

- Do not store in temperatures exceeding 100 °F (38 °C). Avoid direct sunlight and confined areas subject to heat.
- Protect sprinklers and cover assemblies during storage, transport, handling, and after installation.
 - Use original shipping containers.
 - Do not place sprinklers or cover assemblies loose in boxes, bins, or buckets.
- Keep the sprinkler bodies covered with the protective sprinkler cap any time the sprinklers are shipped or handled, during testing of the system, and while ceiling finish work is being completed.
- Use only the designated Viking recessed sprinkler wrench (refer to the appropriate sprinkler data page) to install these sprinklers. **NOTE:** The protective cap is temporarily removed during installation and then placed back on the sprinkler for protection until finish work is completed.
- Do not over-tighten the sprinklers into fittings during installation.
- Do not use the sprinkler deflector to start or thread the sprinklers into fittings during installation.
- Do not attempt to remove drywall, paint, etc., from the sprinklers.
- Remove the plastic protective cap from the sprinkler before attaching the cover plate assembly. **PROTECTIVE CAPS MUST BE REMOVED FROM SPRINKLERS BEFORE PLACING THE SYSTEM IN SERVICE!**

Refer to the appropriate current technical data pages for complete care, handling, and installation instructions. Data pages are included with each shipment from Viking or Viking distributors. They can also be found on the Web site at www.vikinggroupinc.com.



BULLETIN

CARE AND HANDLING
OF SPRINKLERS

The Viking Corporation, 210 N Industrial Park Drive, Hastings MI 49058

Telephone: 269-945-9501 Technical Services: 877-384-5464 Fax: 269-818-1680 Email: techsvcs@vikingcorp.com

USE THE FOLLOWING PRECAUTIONS WHEN HANDLING WAX-COATED SPRINKLERS

Many of Viking's sprinklers are available with factory-applied wax coating for corrosion resistance. These sprinklers MUST receive appropriate care and handling to avoid damaging the wax coating and to assure satisfactory performance of the product.

General Handling and Storage of Wax-Coated Sprinklers:

- Store the sprinklers in a cool, dry place (in temperatures below the maximum ambient temperature allowed for the sprinkler temperature rating. Refer to Table 1 below.)
- Store containers of wax-coated sprinklers separate from other sprinklers.
- Protect the sprinklers during storage, transport, handling, and after installation.
- Use original shipping containers.
- Do not place sprinklers in loose boxes, bins, or buckets.

Installation of Wax-Coated Sprinklers:

Use only the special sprinkler head wrench designed for installing wax-coated Viking sprinklers (any other wrench may damage the unit).

- Take care not to crack the wax coating on the units.
- For touching up the wax coating after installation, wax is available from Viking in bar form. Refer to Table 1 below. The coating MUST be repaired after sprinkler installation to protect the corrosion-resistant properties of the sprinkler.
- Use care when locating sprinklers near fixtures that can generate heat. Do not install sprinklers where they would be exposed to temperatures exceeding the maximum recommended ambient temperature for the temperature rating used.
- Inspect the coated sprinklers frequently soon after installation to verify the integrity of the corrosion resistant coating. Thereafter, inspect representative samples of the coated sprinklers in accordance with NFPA 25. Close up visual inspections are necessary to determine whether the sprinklers are being affected by corrosive conditions.

TABLE 1

Sprinkler Temperature Rating (Fusing Point)	Wax Part Number	Wax Melting Point	Maximum Ambient Ceiling Temperature ¹	Wax Color
155 °F (68 °C) / 165 °F (74 °C)	02568A	148 °F (64 °C)	100 °F (38 °C)	Light Brown
175 °F (79 °C)	04146A	161 °F (71 °C)	150 °F (65 °C)	Brown
200 °F (93 °C)	04146A	161 °F (71 °C)	150 °F (65 °C)	Brown
220 °F (104 °C)	02569A	170 °F (76 °C)	150 °F (65 °C)	Dark Brown
286 °F (141 °C)	02569A	170 °F (76 °C)	150 °F (65 °C)	Dark Brown

¹ Based on NFPA-13. Other limits may apply, depending on fire loading, sprinkler location, and other requirements of the Authority Having Jurisdiction. Refer to specific installation standards.



Never install sprinklers that have been dropped, damaged, or exposed to temperatures in excess of the maximum ambient temperature allowed.

Refer to the appropriate current technical data pages for complete care, handling, and installation instructions. Data pages are included with each shipment from Viking or Viking distributors. They can also be found on the Web site at www.vikinggroupinc.com.



TECHNICAL DATA

SPRINKLER OVERVIEW

The Viking Corporation, 210 N Industrial Park Drive, Hastings MI 49058

Telephone: 269-945-9501 Technical Services: 877-384-5464 Fax: 269-818-1680 Email: techsvcs@vikingcorp.com

1. DESCRIPTION

Viking fire sprinklers consist of a threaded frame with a specific waterway or orifice size and a deflector for distributing water in a specified pattern. A closed or sealed sprinkler refers to a complete assembly, including the thermosensitive operating element. An open sprinkler does not use an operating element and is open at all times. The distribution of water is intended to extinguish a fire or to control its spread.

Viking sprinklers are available in several models and styles. Refer to specific sprinkler technical data pages for available styles, finishes, temperature ratings, thread sizes, and nominal K-Factors for the particular model selected.

2. LISTINGS AND APPROVALS

Refer to the Approval Charts on the appropriate sprinkler technical data page(s) and/or approval agency listings.



WARNING: Cancer and Reproductive Harm-
www.P65Warnings.ca.gov

3. TECHNICAL DATA

Pressure Ratings:

Maximum allowable water working pressure is 175 psig (12 Bar) unless rated and specified for high water working pressure [250 psig (17.2 bar)].

Sprinkler Identification:

Viking sprinklers are identified and marked with the word "Viking", the sprinkler identification number (SIN) consisting of "VK" plus a three digit number*, the model letter, and the year of manufacture.

Available Finishes:

Viking sprinklers are available in several decorative finishes. Some models are available with corrosion-resistant coatings or are fabricated from non-corrosive material. Refer to the sprinkler technical data page for additional information.

Available Temperature Ratings:

Viking sprinklers are available in several temperature ratings that relate to a specific temperature classification. Applicable installation rules mandate the use and limitations of each temperature classification. In selecting the appropriate temperature classification, the maximum expected ceiling temperature must be known. When there is doubt as to the maximum temperature at the sprinkler location, a maximum-reading thermometer should be used to determine the temperature under conditions that would show the highest readings to be expected. In addition, recognized installation rules may require a higher temperature classification, depending upon sprinkler location, occupancy classification, commodity classification, storage height, and other hazards. In all cases, the maximum expected ceiling temperature dictates the lowest allowable temperature classification. Sprinklers located immediately adjacent to a heat source may require a higher temperature rating.

K-Factors:

Viking sprinklers are available in several orifice sizes with related K-Factors. The orifice is a tapered waterway and, therefore, the K-Factor given is nominal. Nominal U.S. K-Factors are provided in accordance with the 1999 edition of NFPA 13, Section 3-2.3. Refer to the specific data page for appropriate K-Factor information.

Available Styles:

Viking sprinklers are available for installation in several positions as indicated by a stamping on the deflector. The deflector style dictates the appropriate installation position of the sprinkler; it breaks the solid stream of water issuing from the sprinkler orifice to form a specific spray pattern. The following list indicates the various styles and identification of Viking sprinklers.

UPRIGHT SPRINKLER: A sprinkler intended to be installed with the deflector above the frame so water flows upward through the orifice, striking the deflector and forming an umbrella-shaped spray pattern downward. Marked "SSU" (Standard Sprinkler Upright) or "UPRIGHT" on the deflector.

PENDENT SPRINKLER: A sprinkler intended to be oriented with the deflector below the frame so water flows downward through the orifice, striking the deflector and forming an umbrella-shaped spray pattern downward. Marked "SSP" (Standard Sprinkler Pendent) or "PENDENT" on the deflector.

CONVENTIONAL SPRINKLER: An "old style" sprinkler intended to be installed with the deflector in either the upright or pendent position. The deflector provides a spherical type pattern with 40 to 60 percent of the water initially directed downward and a proportion directed upward. Must be installed in accordance with installation rules for conventional or old style sprinklers. **DO NOT USE AS A REPLACEMENT FOR STANDARD SPRAY SPRINKLERS.** Marked "C U/P" (Conventional Upright/Pendent) on the deflector.

Viking Technical Data may be found on
The Viking Corporation's Web site at
<http://www.vikinggroupinc.com>.
The Web site may include a more recent
edition of this Technical Data Page.



TECHNICAL DATA

SPRINKLER OVERVIEW

The Viking Corporation, 210 N Industrial Park Drive, Hastings MI 49058

Telephone: 269-945-9501 Technical Services: 877-384-5464 Fax: 269-818-1680 Email: techsvcs@vikingcorp.com

VERTICAL SIDEWALL (VSW) SPRINKLER: A sprinkler intended for installation near the wall and ceiling. The deflector provides a water spray pattern outward in a quarter-spherical pattern and can be installed in the upright or pendent position with the flow arrow in the direction of discharge. Marked "SIDEWALL" on the deflector with an arrow and the word "FLOW". (Note: Some vertical sidewall sprinklers can only be installed in the upright or pendent position—in this case, the sprinkler will also be marked "UPRIGHT" or "PENDENT".)

HORIZONTAL SIDEWALL (HSW) SPRINKLER: A sprinkler intended for installation near the wall and ceiling. The special deflector provides a water spray pattern outward in a quarter-spherical pattern. Most of the water is directed away from the nearby wall with a small portion directed at the wall behind the sprinkler. The top of the deflector is oriented parallel with the ceiling or roof. The flow arrows point in the direction of discharge. Marked "SIDEWALL" and "TOP" with an arrow and the word "FLOW".

EXTENDED COVERAGE (EC) SPRINKLER: A spray sprinkler designed to discharge water over an area having the maximum dimensions indicated in the individual listings. Maximum area of coverage, minimum flow rate, orifice size, and nominal K-Factor are specified in the individual listings. EC sprinklers are intended for Light-Hazard occupancies with smooth, flat, horizontal ceilings unless otherwise specified. In addition to the above markings, the sprinkler is marked "EC".

QUICK RESPONSE (QR) SPRINKLER: A spray sprinkler with a fast-actuating operating element. The use of quick response sprinklers may be limited due to occupancy and hazard. Refer to the Authority Having Jurisdiction (AHJ) prior to installing.

QUICK RESPONSE EXTENDED COVERAGE (QREC) SPRINKLER: A spray sprinkler designed to discharge water over an area having the maximum dimensions indicated in the individual listing. This is a sprinkler with an operating element that meets the criteria for quick response. QREC sprinklers are only intended for Light Hazard occupancies. The sprinkler is marked "QREC".

FLUSH SPRINKLER: A decorative spray sprinkler intended for installation with a concealed piping system. The unit is mounted flush with the ceiling or wall, with the fusible link exposed. Upon actuation, the deflector extends beyond the ceiling or wall to distribute water discharge. The sprinkler is marked "SSP", "PEND", or "SIDEWALL" and "TOP".

CONCEALED SPRINKLER: A decorative spray sprinkler intended for installation with a concealed piping system. The sprinkler is hidden from view by a cover plate installed flush with the ceiling or wall. During fire conditions, the cover plate detaches, and upon sprinkler actuation, the deflector extends beyond the ceiling or wall to distribute water discharge. The sprinkler is marked "SSP", "PEND", or "SIDEWALL" and "TOP".

RECESSED SPRINKLER: A spray sprinkler assembly intended for installation with a concealed piping system. The assembly consists of a sprinkler installed in a decorative adjustable recessed escutcheon that minimizes the protrusion of the sprinkler beyond the ceiling or wall without adversely affecting the sprinkler distribution or sensitivity. Refer to the appropriate technical data page for allowable sprinkler models, temperature ratings, and occupancy classifications. DO NOT RECESS ANY SPRINKLER NOT LISTED FOR USE WITH THE ESCUTCHEON.

CORROSION-RESISTANT SPRINKLER: A special service sprinkler with non-corrosive protective coatings, or that is fabricated from non-corrosive material, for use in atmospheres that would normally corrode sprinklers.

DRY SPRINKLER: A special-service sprinkler intended for installation on dry pipe systems or wet pipe systems where the sprinkler is subject to freezing temperatures. The unit consists of a sprinkler permanently secured to an extension nipple with a sealed inlet end to prevent water from entering the nipple until the sprinkler operates. The unit MUST be installed in a tee fitting. Dry upright sprinklers are marked with the "B" dimension [distance from the face of the fitting (tee) to the top of the deflector]. Dry pendent and sidewall sprinklers are marked with the "A" dimension [the distance from the face of fitting (tee) to the finished surface of the ceiling or wall].

LARGE DROP SPRINKLER: A type of special application sprinkler used to provide fire control of specific high-challenge fire hazards. Large drop sprinklers are designed to produce an umbrella-shaped spray pattern downward with a higher percentage of "large" water droplets than standard spray sprinklers. The sprinkler has an extra-large orifice with a nominal K-Factor of 11.2. Marked "HIGH CHALLENGE" and "UPRIGHT".

EARLY SUPPRESSION FAST-RESPONSE (ESFR) SPRINKLER: A sprinkler intended to provide fire suppression of specific high-challenge fire hazards through the use of a fast response fusible link, 14.0, 16.8, or 25.2 nominal K-Factor, and special deflector. ESFR sprinklers are designed to produce high-momentum water droplets in a hemispherical pattern below the deflector. This permits penetration of the fire plume and direct wetting of the burning fuel surface while cooling the atmosphere early in the development of a high-challenge fire. Marked "ESFR" and "UPRIGHT" or "PEND".

INTERMEDIATE LEVEL/RACK STORAGE SPRINKLER: A standard spray sprinkler assembly designed to protect its operating element from the spray of sprinklers installed at higher elevations. The assembly consists of a standard or large orifice upright or pendent sprinkler with an integral upright or pendent water shield and guard assembly. Use only those sprinklers that have been tested and listed for use with the assembly. Refer to the technical data page for allowable sprinkler models.

RESIDENTIAL SPRINKLER: A sprinkler intended for use in the following occupancies: one- and two-family dwellings with the fire protection sprinkler system installed in accordance with NFPA 13D; residential occupancies up to four stories in height with the fire protection system installed in accordance with NFPA 13R; and where allowed by the Authority Having Jurisdiction in residential portions of any occupancy with the fire protection system installed in accordance with NFPA 13.



TECHNICAL DATA

SPRINKLER OVERVIEW

The Viking Corporation, 210 N Industrial Park Drive, Hastings MI 49058

Telephone: 269-945-9501 Technical Services: 877-384-5464 Fax: 269-818-1680 Email: techsvcs@vikingcorp.com

Residential sprinklers have a unique distribution pattern and utilize a “fast response” heat sensitive operating element. They enhance survivability in the room of fire origin and are designed to provide a life safety environment for a minimum of ten minutes. For this reason, residential sprinklers must not be used to replace standard sprinklers unless tested for and approved by the Authority Having Jurisdiction. In addition to standard markings, the unit is identified as “RESIDENTIAL SPRINKLER” or “RES”.

4. INSTALLATION

Refer to appropriate NFPA Installation Standards.

5. OPERATION

Refer to the appropriate sprinkler technical data page(s).

6. INSPECTIONS, TESTS AND MAINTENANCE

Refer to NFPA 25 for Inspection, Testing and Maintenance requirements.

7. AVAILABILITY

Viking sprinklers are available through a network of domestic and international distributors. See The Viking Corporation web site for the closest distributor or contact The Viking Corporation.

8. GUARANTEE

For details of warranty, refer to Viking’s current list price schedule or contact Viking directly.

IMPORTANT: Always refer to Bulletin Form No. F_091699 - Care and Handling of Sprinklers and the appropriate sprinkler general care, installation, and maintenance guide. Vikings sprinklers are to be installed in accordance with the latest edition of Viking technical data, the appropriate standards of NFPA, FM Global, LPCB, APSAD, VdS or other similar organizations, and also with the provisions of governmental codes, ordinances, and standards, whenever applicable. The sprinkler technical data page may contain installation requirements specific for the sprinkler model selected. The use of certain types of sprinklers may be limited due to occupancy and hazard. Refer to the Authority Having Jurisdiction prior to installation.

**BULLETIN****REGULATORY AND HEALTH
WARNINGS**

The Viking Corporation, 210 N Industrial Park Drive, Hastings MI 49058

Telephone: 269-945-9501 Technical Services: 877-384-5464 Fax: 269-818-1680 Email: techsvcs@vikingcorp.com

Visit the Viking website for the latest edition of this technical data page www.vikinggroupinc.com

1. DESCRIPTION

Regulatory and Health Warnings applying to materials used in the manufacture and construction of fire protection products are provided herein as they relate to legally mandated jurisdictional regions.

⚠ WARNING**STATE OF CALIFORNIA, USA**

Installing or servicing fire protection products such as sprinklers, valves, piping etc. can expose you to chemicals including, but not limited to, lead, nickel, butadiene, titanium dioxide, chromium, carbon black, and acrylonitrile which are known to the State of California to cause cancer or birth defects or other reproductive harm.

For more information, go to www.P65Warnings.ca.gov

2. WARRANTY TERMS AND CONDITIONS

For details of warranty, refer to Viking's current list price schedule at www.vikinggroupinc.com or contact Viking directly.