



TECHNICAL DATA

COIN® QUICK RESPONSE UPRIGHT SPRINKLER VK950 (SPECIFIC APPLICATION)

The Viking Corporation, 210 N Industrial Park Drive, Hastings MI 49058

Telephone: 269-945-9501 Technical Services: 877-384-5464 Fax: 269-818-1680 Email: techsvcs@vikingcorp.com

Visit the Viking website for the latest edition of this technical data page: www.vikinggroupinc.com

1. DESCRIPTION

Viking QR COIN® Sprinklers are quick response specific application sprinklers for combustible interstitial (concealed) spaces (i.e., between floors, as well as low pitch attics that meet the criteria shown in the figures in this data page). These upright sprinklers are designed for use in specific light hazard combustible, as well as non-combustible, concealed spaces requiring sprinkler protection. The orifice design of the Viking QR COIN® Sprinkler, with a nominal K-factor of 5.6 (80 metric*), allows efficient use of available water supplies for hydraulically designed fire protection systems. The glass bulb operating element and special deflector combine speed of operation and area of coverage to meet the crucial fire protection requirement for shallow space combustible concealed spaces. The Electroless Nickel PTFE (ENT) coating has been investigated for installation in corrosive environments and is listed/approved as indicated in the Approval Charts.

FEATURES

- In some cases COIN® Sprinklers can allow the use of CPVC piping within the concealed spaces of applications requiring sprinkler protection in open truss construction of both wood and steel trusses (see Figure 3) and solid wood or composite wood joist with upper deck filled with non-combustible insulation (see Figure 5).
- COIN® Sprinklers can also be installed with steel pipe in protected areas constructed of solid wood joists (see Figure 7), and solid wood or composite wood joist with upper deck filled with non-combustible insulation (see Figure 8), and in unobstructed open truss construction of both wood and steel trusses (see Figures 9 and 10) as well as obstructed wood truss construction (see Figure 11).
- When using steel pipe, COIN® Sprinklers can be applied as a dry system using air or gas as a supervisory medium (see Figures 7–11).
- In certain scenarios, draft curtains are **NOT** required when sprinkler spacing meets either of the following criteria (also refer to Design Criteria):
 - 14' X 14' (4,3 m X 4,3 m) for solid wood joists or trusses on edge
 - 16' X 16' (4,9 m X 4,9 m) for truss construction on face (not on edge)
 For examples of trusses on face or edge see Figures 13A and 13B.



COIN® Sprinkler

VK950

5.6K (80 metric)



WARNING: Cancer and Reproductive Harm-
www.P65Warnings.ca.gov

2. LISTINGS AND APPROVALS

cULus Listed: Category VNIV

Refer to the Approval Chart and Design Criteria in this technical data sheet for cULus Listing requirements that must be followed.

The COIN® Sprinkler has been tested to address the proper application density for shallow concealed combustible space fire protection when installed in accordance with this technical data page. The COIN® Sprinkler must be installed in the upright position as specified in the appropriate application described in Figures 3–12. The clearance from the sprinkler deflector to the roof is critical to operation of the sprinkler (refer to Figures 3–12). The clearances from pipe to lower ceiling for CPVC pipe is critical for protection of CPVC pipe.

For open truss and joist spaces, the maximum detection area is important for proper installation.

In certain installations, draft curtains or heat collection baffles or solid walls are **required** using wood or other product that will not allow heat to escape. In these installations, the maximum detection space shall be **limited** to 1000 ft² (93 m²) or 2000 ft² (185 m²) for solid wood joists. The draft curtain is required to protrude down from the top deck surface as specified herein.

Additionally, draft curtains are **not** required and the maximum detection space shall be **unlimited** for open truss construction with the top chord member on their face (not on edge) when sprinkler spacing is up to 16' X 16' (4,9 m X 4,9 m) and for solid wood joists or trusses on edge when sprinkler spacing is up to 14' X 14' (4,3 m X 4,3 m). In these cases, draft curtains are **not required**.



TECHNICAL DATA

COIN® QUICK RESPONSE UPRIGHT SPRINKLER VK950 (SPECIFIC APPLICATION)

The Viking Corporation, 210 N Industrial Park Drive, Hastings MI 49058

Telephone: 269-945-9501 Technical Services: 877-384-5464 Fax: 269-818-1680 Email: techsvcs@vikingcorp.com

Visit the Viking website for the latest edition of this technical data page: www.vikinggroupinc.com

3. TECHNICAL DATA

Specifications:

Minimum Operating Pressure: Refer to Design Criteria in this technical data sheet.

Rated to 175 psi (12 bar) water working pressure

Factory tested hydrostatically to 500 psi (34.5 bar)

Thread size: 1/2" (15 mm) NPT

Nominal K-Factor: 5.6 U.S. (80 metric*)

* Metric K-factor measurement shown is when pressure is measured in Bar. When pressure is measured in kPa, divide the metric K-factor shown by 10.0.

Glass-bulb fluid temperature rated to -65 °F (-55 °C)

Overall Length: 2-1/4" (57 mm)

Material Standards:

Frame Casting: Brass UNS-C84400 or QM Brass

Deflector: Phosphor Bronze UNS-C51000

Bulb: Glass, nominal 3 mm diameter

Belleville Spring Sealing Assembly: Nickel Alloy, coated on both sides with PTFE Tape

Screw: Brass UNS-C36000

Pip Cap and Insert Assembly: Copper UNS-C11000 and Stainless Steel UNS-S30400

Ordering Information: (Refer to Table 1.)

4. INSTALLATION

Refer to appropriate NFPA Installation Standards.

5. OPERATION

During a fire condition, the heat sensitive liquid in the glass bulb expands, causing the glass to shatter, releasing the pip cap and sealing spring assembly. Water flowing through the sprinkler orifice strikes the deflector, forming a uniform spray pattern to extinguish or control the fire, and protect the piping in the interstitial space.

6. INSPECTIONS, TESTS AND MAINTENANCE

Refer to NFPA 25 for Inspection, Testing and Maintenance requirements.

7. AVAILABILITY

The Viking QR COIN® Sprinkler is available through a network of domestic and international distributors. See The Viking Corporation web site for the closest distributor or contact The Viking Corporation.

8. GUARANTEE

For details of warranty, refer to Viking's current list price schedule or contact Viking directly.

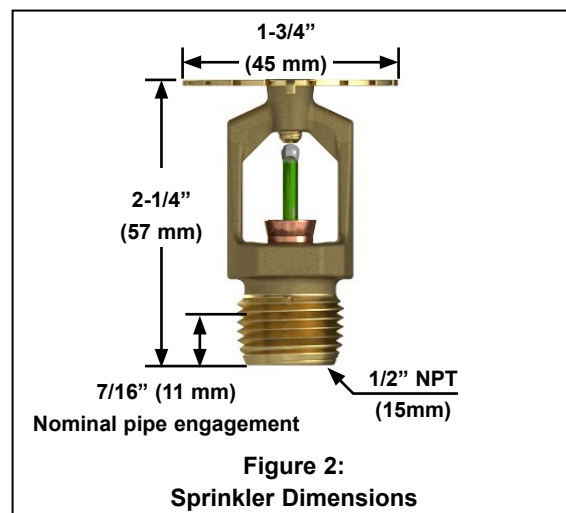
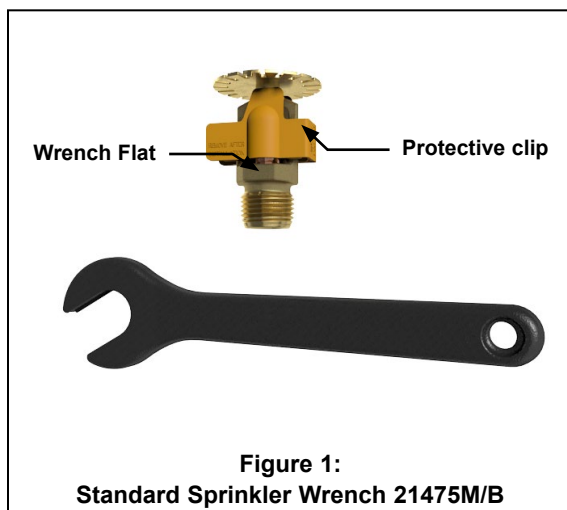



TECHNICAL DATA

COIN® QUICK RESPONSE UPRIGHT SPRINKLER VK950 (SPECIFIC APPLICATION)

The Viking Corporation, 210 N Industrial Park Drive, Hastings MI 49058
 Telephone: 269-945-9501 Technical Services: 877-384-5464 Fax: 269-818-1680 Email: techsvcs@vikingcorp.com
 Visit the Viking website for the latest edition of this technical data page: www.vikinggroupinc.com

TABLE 1: ORDERING INFORMATION

Instructions: Using the sprinkler base part number,
 (1) add the suffix for the desired Finish
 (2) add the suffix for the desired Temperature Rating.

Sprinkler Base Part No.	Size	1: Finishes		2: Temperature Ratings ⁴ Classification: Intermediate			
	NPT Inch	Description	Suffix	Nominal Rating	Bulb Color	Max. Ambient Ceiling Temperature ¹	Suffix
20757	1/2	Brass	A	200 °F (93 °C)	Green	150 °F (65 °C)	E
		ENT ^{2,3}	JN				

Corrosion-Resistant Coating:
 ENT^{2,3}

Example: 20757AE = VK950 with Brass Finish and 200 °F (93 °C) Nominal temperature rating. This sprinkler is to be installed into an area with a maximum ambient temperature of 150 °F (65 °C) meaning if the area will experience temperatures above the maximum ambient rating, you shall use a higher temperature-rated sprinkler.

Accessories

Sprinkler Wrenches (see Figure 1):

A. Standard Wrench: Part No. 21475MB.

Sprinkler Cabinet:

A. Up to 6 sprinklers: Part number 01724A.

B. 6-12 Sprinklers: Part number 01725A.

Footnotes

- Based on NFPA 13, NFPA 13R, and NFPA 13D. Other limits may apply, depending on fire loading, sprinkler location, and other requirements of the Authority Having Jurisdiction. Refer to specific installation standards.
- cULus Listed as corrosion resistant.
- The corrosion resistant coatings have passed the standard corrosion test required by the approving agencies indicated in the Approval Chart. These tests cannot and do not represent all possible corrosive environments. Prior to installation, verify through the end-user that the coatings are compatible with or suitable for the proposed environment. For automatic sprinklers, the ENT coating is applied to all exposed exterior surfaces, including the waterway. For ENT coated sprinklers, the Belleville spring is exposed.
- The sprinkler temperature rating is stamped on the deflector.

Approval Chart

COIN® Specific Application QR Upright Sprinkler VK950
 For Light Hazard Occupancies Only

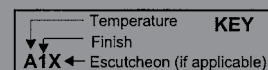

Part Number ¹	SIN	Maximum Pressure	Thread Size		Nominal K-Factor		Overall Length		Listings and Approvals ³ (Refer also to Design Criteria.) cULus ⁴	
			NPT	BSPT	U.S.	metric ²	Inches	mm		
20757	VK950	175 psi	1/2"	15 mm	5.6	80	2-1/4	57	A1	
Approved Temperature Rating A - 200 °F (93 °C)							Approved Finish 1 - Brass, ENT ⁶			

Footnotes

- Also refer to Viking's current price schedule.
- Metric K-factor measurement shown is when pressure is measured in Bar. When pressure is measured in kPa, divide the metric K-factor shown by 10.0.
- This table shows the listings and approvals available at the time of printing. Other approvals may be in process.
- Listed by Underwriters Laboratories Inc. for use in the U.S. and Canada.
- Meets New York City requirements, effective July 1, 2008.
- cULus Listed as corrosion resistant.



TECHNICAL DATA

COIN® QUICK RESPONSE UPRIGHT SPRINKLER VK950 (SPECIFIC APPLICATION)

The Viking Corporation, 210 N Industrial Park Drive, Hastings MI 49058
 Telephone: 269-945-9501 Technical Services: 877-384-5464 Fax: 269-818-1680 Email: techsvcs@vikingcorp.com
 Visit the Viking website for the latest edition of this technical data page: www.vikinggroupinc.com

DESIGN CRITERIA - CPVC PIPE (See Figures 3-6)

(Also refer to the Approval Chart on page 3.)

The Viking COIN® Sprinkler MUST be installed in the upright position.

APPLICATION

For installation in horizontal interstitial concealed spaces constructed of engineered open wood trusses, open bar joist, and non-combustible insulation completely filling the upper joist for solid or composite wood joist construction having roof pitch of up to 2/12.

NOTE: In order to be considered "non-combustible insulation filled solid wood or composite wood joist construction", the insulation (including insulation provided with a combustible vapor barrier), must completely fill the pockets between the joists to the bottom of the joists, and the insulation must be secured in place with metal wire netting. The metal wire netting is intended to hold the insulation in place should the insulation become wetted by the operation of the COIN® Sprinklers in the event of a fire.

A. Concealed Space Limitations

The total concealed space is not limited; however, the following must be observed:

- Draft curtains (heat collection baffle) or full height walls must be provided to limit the maximum area in order to confine heat of localized detection area to 1000 ft² (93 m²) or, for solid wood joists and open truss construction with the top chord members on face (not on edge) to 2000 ft² (185 m²).
- Insulated top chord spaces (on edge) confine heat localized detection area to 2000 ft², non-insulated top chord spaces (on edge) confine heat localized area to 1000 ft² (93 m²).
- The draft curtain must be at least 1/3 the depth of the concealed space or 8" (200 mm), whichever is greater, for open truss construction, open bar joist, and non-combustible insulation filled solid or composite wood joist construction.
- The draft curtain must be constructed of material that will not allow heat to escape through or above it; this may be 1/4" (6 mm) thick plywood.
- Draft curtains are NOT required when sprinkler spacing is up to 14' X 14' (4,3 m X 4,3 m) for solid wood joists or trusses on edge; see Figure 13B.
- Draft curtains are NOT required when sprinkler spacing is up to 16' X 16' (4,9 m X 4,9 m) for truss construction on face (not on edge); see Figure 13A.
- Draft curtains are NOT required when using wood truss construction with chords on face and non-combustible insulation is provided to the bottom of the trusses (Figure 12).

B. Concealed Space Height

Open Wood Truss and Open Steel Joist Construction (Figure 3):

- Maximum height of the space: 60" (1.5 m).
- Minimum height: 6" (150 mm)
- Maximum roof pitch: 2/12 (9°)

Where applied to pitch roof and flat ceiling, maintain specified clearances from sprinkler deflector to truss and maximum height of pipe run to ceiling or non-combustible ceiling insulation in all locations. **NOTE:** The sprinkler deflector shall be installed parallel with the roof plane.

Solid wood or composite wood joist with non-combustible filled insulation only (Figure 5):

- Maximum depth of concealed space is 60" (1500 mm) from bottom of upper deck joist to top of ceiling joist.
- Minimum depth is 6" (152 mm) from bottom of upper deck joist to top of ceiling joist or non-combustible ceiling insulation.

C. System Type

- Light Hazard, Wet Pipe System

D. Minimum Density

- 0.10 gpm/ft² (4.1 mm/min).

E. Spacing of COIN® Sprinklers

- Minimum Spacing: 6'-0" (1.8 m)
- Maximum Spacing: 16'-0" (4.9 m)

NOTE: Minimum spacing does not include additional sprinklers required for obstructions for use of CPVC pipe that includes offsets.

F. Maximum Area of Coverage

- 256 ft² (24 m²)

G. Minimum Operating Pressure

- 7.0 PSI (0.5 bar)

H. COIN® Sprinkler Deflector Position

The COIN® Sprinkler shall be installed in the upright position. The frame arms must be installed parallel with the pipe.

- 1-1/2" to 4" (40 - 100 mm) below upper deck for Open Wood Truss and Open Steel Open Joist Construction Using CPVC Pipe (see Figure 3).
- 1-1/2" to 4" (40 - 100 mm) below non-combustible insulation-filled upper deck for Open Wood Truss and Open Steel Open Joist Construction with Using CPVC Pipe (see Figure 4).
- 1-1/2" to 4" (40 - 100 mm) below non-combustible insulation-filled solid wood joists or composite wood joists (see Figure 5).

(continues on page 5.)



TECHNICAL DATA

COIN® QUICK RESPONSE UPRIGHT SPRINKLER VK950 (SPECIFIC APPLICATION)

The Viking Corporation, 210 N Industrial Park Drive, Hastings MI 49058
 Telephone: 269-945-9501 Technical Services: 877-384-5464 Fax: 269-818-1680 Email: techsvcs@vikingcorp.com
 Visit the Viking website for the latest edition of this technical data page: www.vikinggroupinc.com

DESIGN CRITERIA - CPVC PIPE (See Figures 3-6)

(Also refer to the Approval Chart)

(continued from page 4.)

I. Remote Area

For wet pipe systems,

- The remote area for open wood truss construction or open bar joist construction with the top chord members on face (not on edge) is 1000 ft² (93 m²) or 6 sprinklers, whichever is greater. See Table 2.
 - Draft curtains are NOT required when sprinkler spacing is up to 16' X 16' (4,9 m X 4,9 m). The remote area for this application is the same as above.
- The remote area for solid wood joists is 1000 ft² (93 m²) or 6 sprinklers, whichever is greater. See Table 2.
 - Draft curtains are NOT required when sprinkler spacing is up to 14' X 14' (4,3 m X 4,3 m). The remote area for this application is the same as above.
- The remote area for open wood truss construction with the top chord members on edge is 1000 ft² (93 m²) or 6 sprinklers, whichever is greater. See Table 2.
 - Draft curtains are NOT required when sprinkler spacing is up to 14' X 14' (4,3 m X 4,3 m) The remote area for this application is the same as above.
- The remote area for composite wood joists is 1000 ft² (93 m²).

NOTE: This area does not include additional sprinklers for protection of CPVC pipe over obstructions.

J. UL Listed CPVC Pipe for use with COIN™ Sprinklers

The Viking COIN® Sprinkler is UL Listed for use with CPVC pipe products listed for use in concealed spaces with sprinklers**.

**Currently listed products are manufactured under the BlazeMaster®, FireLock®, and FlameGuard® trade names.

In order to use CPVC products, the bottom of the horizontal run must be no greater than 6" (150 mm) or 1/3 of the total space, whichever is smaller, above the ceiling or non-combustible insulation or 1/3 the depth of the space measured from the top surface of the ceiling to the bottom of the deck above. The CPVC pipe can supply the COIN® Sprinklers and the ceiling sprinklers below. Use all guidelines and installation instructions as specified by the CPVC pipe manufacturers unless specified differently in this data sheet. When using 1" (DN25) pipe or larger, a hanger must be located at the truss nearest the sprig for restraint. If using ¾" (DN20), all sprigs over 12" (300 mm) must include lateral bracing.

For use of listed CPVC pipe products in concealed spaces using the COIN® Sprinkler, a minimum lateral distance of 18" (450 mm) must be maintained between the CPVC pipe and the heat sources (e.g. HVAC heat pump units, fan motors, and heat lamps, etc.)

Where CPVC pipe must be installed above the maximum distance of 6" (150 mm) or 1/3 of the total space, whichever is smaller, above the ceiling or non-combustible insulation when piping around obstructions, additional COIN® Sprinklers must be installed as shown in Figures 3, 4, and 5 in order to protect the CPVC product.

NOTE: Where CPVC piping is installed as a vertical riser to the next floor above, refer to Figure 6 for acceptable options.

TABLE 2: PRESSURE VS. COVERAGE MATRIX

All values based on 0.1 gpm/ft² density per sprinkler or 7 psi (0.5 bar) whichever is higher.

Ft. (m)	PSI (bar)								
	16 (4.8)	7 (0.4)	7.2 (0.4)	8.2 (0.5)	10.3 (0.7)	12.8 (0.8)	14.1 (0.9)	16.9 (1.1)	18.4 (1.2)
15 (4.5)	7 (0.4)	7 (0.4)	7.2 (0.4)	9.2 (0.6)	10.3 (0.7)	12.8 (0.8)	14.1 (0.9)	16.9 (1.1)	18.4 (1.2)
14 (4.2)	7 (0.4)	7 (0.4)	7 (0.4)	8.2 (0.5)	9.2 (0.6)	11.5 (0.7)	12.8 (0.8)	14.1 (0.9)	16.9 (1.1)
13 (3.9)	7 (0.4)	7 (0.4)	7 (0.4)	7 (0.4)	8.2 (0.5)	9.2 (0.6)	11.5 (0.7)	12.8 (0.8)	14.1 (0.9)
12 (3.6)	7 (0.4)	7 (0.4)	7 (0.4)	7 (0.4)	7 (0.4)	8.2 (0.5)	9.2 (0.6)	10.3 (0.7)	12.8 (0.8)
11 (3.3)	7 (0.4)	7 (0.4)	7 (0.4)	7 (0.4)	7 (0.4)	7 (0.4)	8.2 (0.5)	9.2 (0.6)	10.3 (0.7)
10 (3.0)	7 (0.4)	7 (0.4)	7 (0.4)	7 (0.4)	7 (0.4)	7 (0.4)	7 (0.4)	7.2 (0.4)	8.2 (0.5)
9 (2.7)	7 (0.4)	7 (0.4)	7 (0.4)	7 (0.4)	7 (0.4)	7 (0.4)	7 (0.4)	7 (0.4)	7.2 (0.4)
8 (2.4)	7 (0.4)	7 (0.4)	7 (0.4)	7 (0.4)	7 (0.4)	7 (0.4)	7 (0.4)	7 (0.4)	7 (0.4)
Ft. (m)	8 (2.4)	9 (2.7)	10 (3.0)	11 (3.3)	12 (3.6)	13 (3.9)	14 (4.2)	15 (4.5)	16 (4.8)

NOTES:

- This table applies to heat collection areas of 2000 ft² (185 m²) and greater (unlimited).
- Design areas between table spacing values need to be rounded up.
- This table does not apply to heat collection areas of 1000 ft² (93 m²).



TECHNICAL DATA

COIN® QUICK RESPONSE UPRIGHT SPRINKLER VK950 (SPECIFIC APPLICATION)

The Viking Corporation, 210 N Industrial Park Drive, Hastings MI 49058
 Telephone: 269-945-9501 Technical Services: 877-384-5464 Fax: 269-818-1680 Email: techsvcs@vikingcorp.com
 Visit the Viking website for the latest edition of this technical data page: www.vikinggroupinc.com

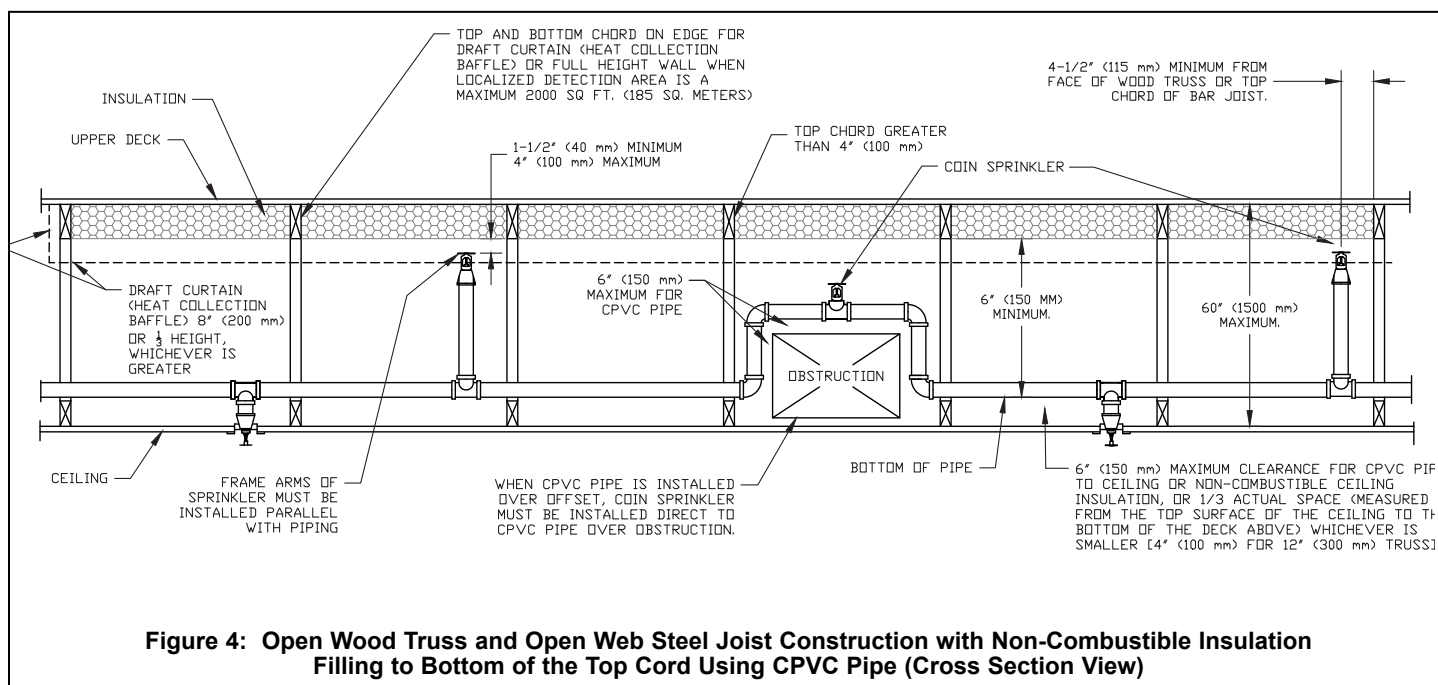
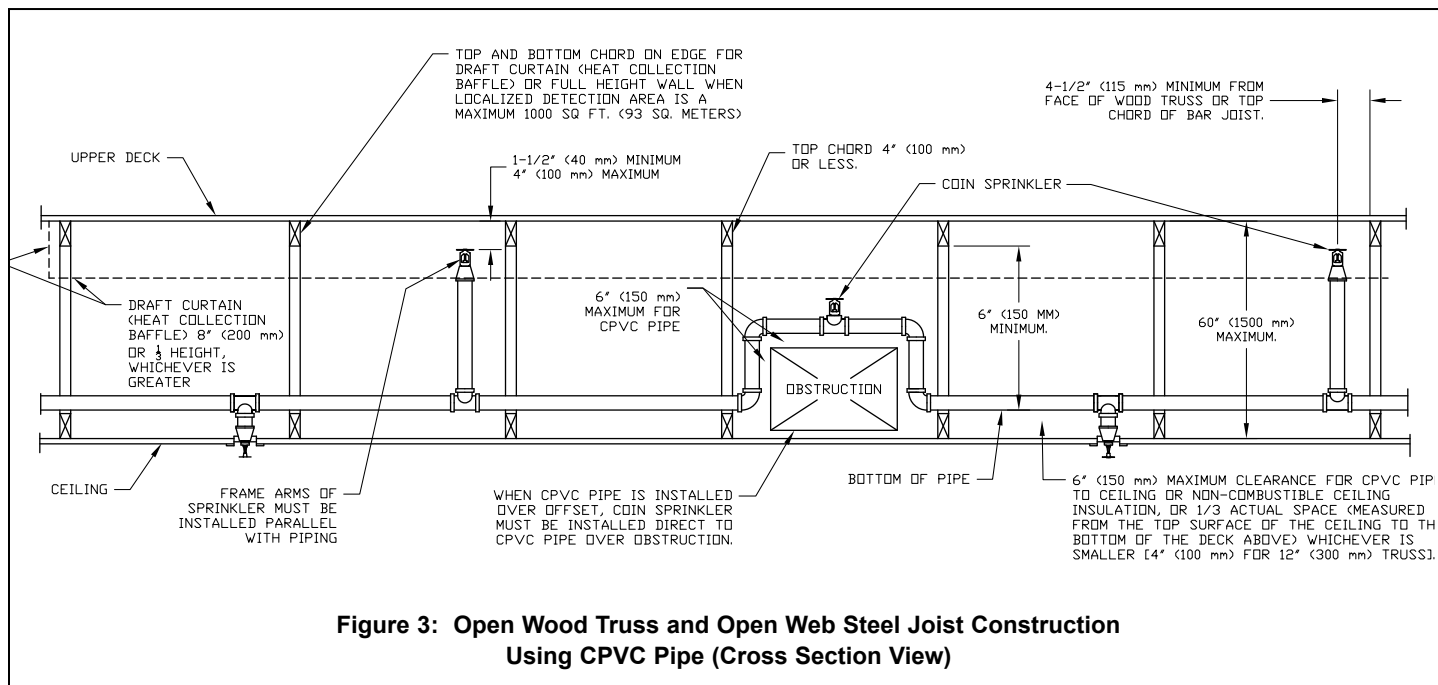



TECHNICAL DATA

**COIN® QUICK
RESPONSE UPRIGHT
SPRINKLER VK950
(SPECIFIC APPLICATION)**

The Viking Corporation, 210 N Industrial Park Drive, Hastings MI 49058
 Telephone: 269-945-9501 Technical Services: 877-384-5464 Fax: 269-818-1680 Email: techsvcs@vikingcorp.com
 Visit the Viking website for the latest edition of this technical data page: www.vikinggroupinc.com

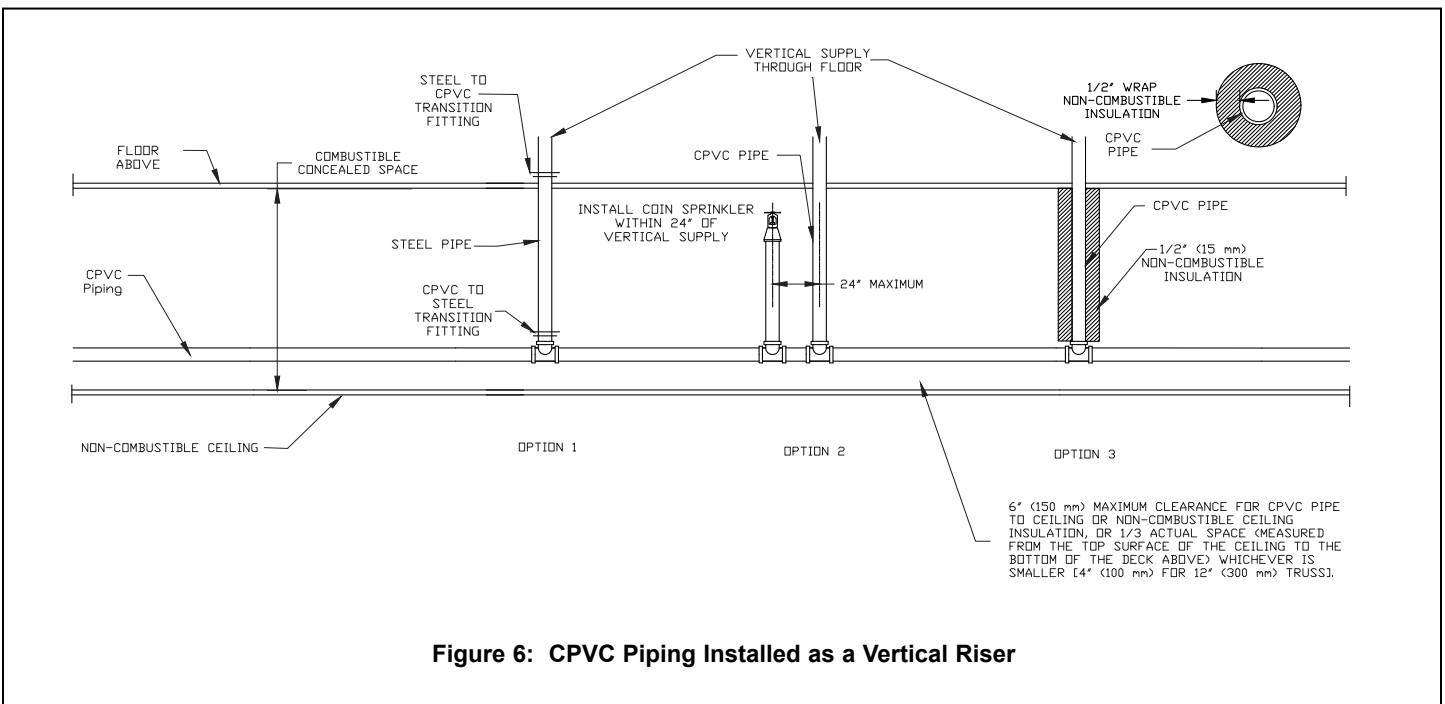
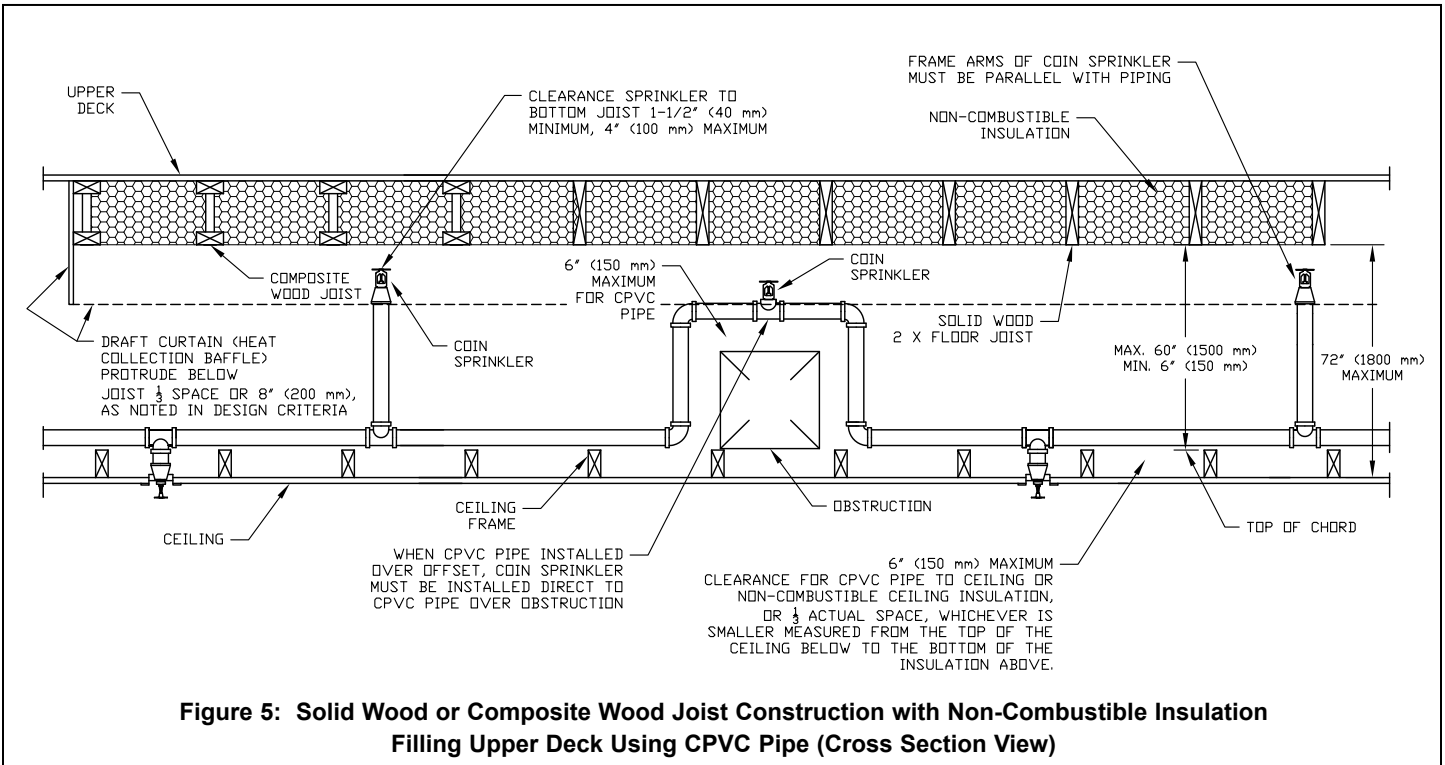



TECHNICAL DATA

COIN® QUICK RESPONSE UPRIGHT SPRINKLER VK950 (SPECIFIC APPLICATION)

The Viking Corporation, 210 N Industrial Park Drive, Hastings MI 49058
 Telephone: 269-945-9501 Technical Services: 877-384-5464 Fax: 269-818-1680 Email: techsvcs@vikingcorp.com
 Visit the Viking website for the latest edition of this technical data page: www.vikinggroupinc.com

DESIGN CRITERIA - STEEL PIPE (See Figures 7 – 12)

(Also refer to the Approval Chart on page 3)

The Viking COIN® Sprinkler MUST be installed in the upright position.

APPLICATION

For installation in horizontal concealed spaces of solid wood joist construction with a roof pitch of up to 2/12 maximum. The upper joist is constructed of solid wood or composite wood with a maximum depth of 12" (300 mm) and 16" (400 mm) on center minimum spacing. Also, steel pipe may be applied in truss construction and solid filled non-combustible insulation in upper deck and wood or composite joist construction similar to that shown in Figures 3-5 with the exception of extra sprinklers are not required over obstructions. Also, there is no minimum clearance for supply pipe to upper joists. With the COIN® Sprinkler applied using steel pipe, the system may be wet, dry, or preaction type for wood truss or steel construction; solid wood or composite with non-combustible solid fill insulation (see Paragraph J on page 9).

NOTE: *In order to be considered "non-combustible insulation filled solid wood or composite wood joist construction", the insulation (including insulation provided with a combustible vapor barrier), must completely fill the pockets between the joists to the bottom of the joists, and the insulation must be secured in place with metal wire netting. The metal wire netting is intended to hold the insulation in place should the insulation become wetted by the operation of the COIN® Sprinklers in the event of a fire.*

A. Concealed Space Limitations

The total concealed space is not limited; however, the following must be observed:

- Blocking between joists and upper deck must be constructed of material that will not allow heat to escape through or above the blocking.
- The blocking must be constructed to the full depth of the upper joist, and must be constructed using a non-combustible material or a material that is the same as that of the joist construction. A maximum channel space for blocking is 32 ft (10 m) intervals.
- Solid wall construction or draft curtains (heat collection baffles) must protrude below the joist a minimum of 6" (150 mm) or 1/3 the space, whichever is greatest, and run laterally with the joist spaced at 31 ft (9.4 m) width maximum to limit the heat detection space to a maximum of 1,000 ft² (93 m²) or with the truss spaced at 62 ft (19 m) width maximum to limit the heat detection space for open wood truss construction to 2000 ft² (185 m²) with their top chord members on face (not on edge) and 2000 ft² (185 m²) for solid wood joists.
- Insulated top chord spaces (on edge) confine heat localized detection area to 2000 ft² (185 m²), non-insulated top chord spaces on edge confine heat localized area to 1,000 ft² (93 m²).
- The draft curtain may be constructed of 1/4" (6 mm) thick plywood to prevent heat from escaping beyond.
- When non-combustible solid filled insulation is used, the wood blocking and draft curtains are not required for solid wood or composite wood joist construction.
- Draft curtains are NOT required when sprinkler spacing is up to 14' X 14' (4.3 m X 4.3 m) for solid wood joists or trusses on edge for wet systems only; see Figure 13B.
- Draft curtains are NOT required when sprinkler spacing is up to 16' X 16' (4.9 m X 4.9 m) for truss construction on face (not on edge) for wet or dry systems; see Figure 13A.
- Draft curtains are NOT required when using wood truss construction with chords on face and non-combustible insulation is provided to the bottom of the trusses (Figure 12).

B. Concealed Space Height

Solid Wood or Composite Wood Joist Construction (See Figures 7 and 8):

- Maximum depth or height of concealed space: 60" (1500 mm) from bottom of upper deck joist to top of ceiling joist.
- Maximum space from bottom of upper deck to ceiling surface (bottom of joist): 84" (2100 mm). See Figure 7.
- Minimum depth or height of concealed space: 6" (150 mm) from bottom of upper deck joist to top of ceiling frame joist.

Open Wood Truss or Open Web Steel Joist (See Figure 10):

- Maximum height from inside ceiling to inside deck of concealed space: 60" (1500 mm).
- Minimum height from bottom of upper chords to top of lower chords: 6" (150 mm)
- The top and bottom chord members of these types of wood joists must be on face (not on edge).

Obstructed Wood Truss (See Figure 11):

- Maximum depth of concealed space: 84" (2100 mm) from bottom of upper deck to top of ceiling.
- Minimum depth of concealed space: 6" (150 mm) from bottom of upper chord to top of lower chord.

C. System Type

- Light hazard, wet pipe system or dry pipe system supervised with air or gas when using steel pipe only.

D. Minimum Density

- 0.10 gpm/ft². (4.1 mm/min).

E. Spacing of COIN® Sprinklers

- Minimum Space Between Sprinklers: 6'-0" (1.8 m)
- Maximum Space Between Sprinklers: 16'-0" (4.9 m)

F. Maximum Area of Coverage

- 256ft² (24 m²)

G. Minimum Operating Pressure

- 7.0 PSI (0.5 bar)

H. COIN® Sprinkler Deflector Position

The COIN® Sprinkler shall be installed in the upright position. The frame arms must be installed parallel with the pipe.

- 1-1/2" to 2" (40 - 50 mm) below solid wood joist or top chord of obstructed wood truss construction. See Figures 7 and 11.
 - 1-1/2" to 4" (40 - 100 mm) below upper deck for unobstructed open wood truss construction or concealed spaces of non-combustible open steel joist construction. See Figures 8 and 9.
 - 1-1/2" to 4" (40 - 100 mm) below non-combustible insulation-filled solid wood joists or composite wood joists. See Figure 8.
- (continues on page 9.)



TECHNICAL DATA

**COIN® QUICK
RESPONSE UPRIGHT
SPRINKLER VK950
(SPECIFIC APPLICATION)**

The Viking Corporation, 210 N Industrial Park Drive, Hastings MI 49058
 Telephone: 269-945-9501 Technical Services: 877-384-5464 Fax: 269-818-1680 Email: techsvcs@vikingcorp.com
 Visit the Viking website for the latest edition of this technical data page: www.vikinggroupinc.com

DESIGN CRITERIA - STEEL PIPE (See Figures 7–12)
 (Also refer to the Approval Chart on page 3)

(continued from page 8)

I. Remote Area

For wet pipe systems,

1. The remote area for open wood truss construction or open bar joist construction with the top chord members on face (not on edge) is 1000 ft² (93 m²) or 6 sprinklers, whichever is greater. See Table 2.
 - Draft curtains are NOT required when sprinkler spacing is up to 16' X 16' (4,9 m X 4,9 m). The remote area for this application is the same as above.
2. The remote area for solid wood joists is 1000 ft² (93 m²) or 6 sprinklers, whichever is greater. See Table 2.
 - Draft curtains are NOT required when sprinkler spacing is up to 14' X 14' (4,3 m X 4,3 m). The remote area for this application is the same as above.
3. The remote area for open wood truss construction with the top chord members on edge is 1000 ft² (93 m²) or 6 sprinklers, whichever is greater. See Table 2.
 - Draft curtains are NOT required when sprinkler spacing is up to 14' X 14' (4,3 m X 4,3 m) The remote area for this application is the same as above.
4. The remote area for composite wood joists is 1000 ft² (93 m²).

For dry pipe systems,

1. The remote area for open wood truss construction or open bar joist construction with the top chord members on face (not on edge) is 1000 ft² (93 m²) or 6 sprinklers, whichever is greater. See Table 2.
 - Draft curtains are NOT required when sprinkler spacing is up to 16' X 16' (4,9 m X 4,9 m). The remote area for this application is the same as above.
2. The remote area for solid wood joists is 2000 ft² (185 m²) or 15 sprinklers, whichever is greater. See Table 2.
3. The remote area for open wood truss construction with the top chord members on edge is 1000 ft² (93 m²).
4. The remote area for composite wood joists is 1000 ft² (93 m²).

J. Piping System

Steel pipe installed in accordance with NFPA 13 standards may be applied. The steel pipe may be hung from the upper joist or truss using proper supports. The sprinkler deflector must be positioned as indicated in paragraph H above. Extra sprinklers are not required for protection of pipe when offsetting for obstructions. Ceiling sprinklers below the concealed space may be fed from the same piping as the COIN® Sprinklers.

IMPORTANT: Always refer to Bulletin Form No. F_091699 - Care and Handling of Sprinklers. Also refer to Bulletin Form No. F_080614 for general care, installation, and maintenance information. Viking sprinklers are to be installed in accordance with the latest edition of Viking technical data, the appropriate standards of NFPA, FM Global, LPCB, APSAD, VdS or other similar organizations, and also with the provisions of governmental codes, ordinances, and standards, whenever applicable.

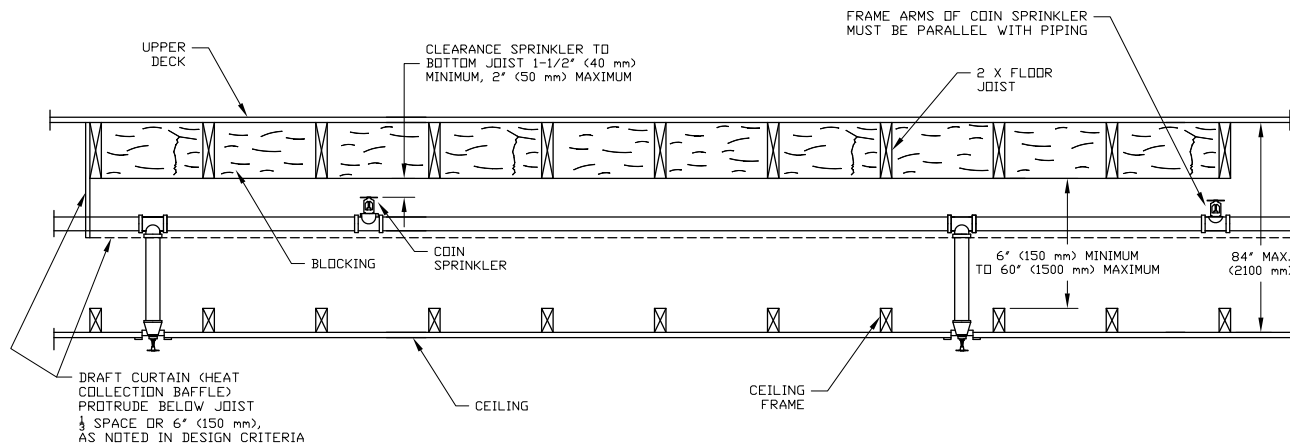

Figure 7: Solid Wood Joist Construction (Steel Pipe, Cross Sectional View)



TECHNICAL DATA

**COIN® QUICK
RESPONSE UPRIGHT
SPRINKLER VK950
(SPECIFIC APPLICATION)**

The Viking Corporation, 210 N Industrial Park Drive, Hastings MI 49058
 Telephone: 269-945-9501 Technical Services: 877-384-5464 Fax: 269-818-1680 Email: techsvcs@vikingcorp.com
 Visit the Viking website for the latest edition of this technical data page: www.vikinggroupinc.com

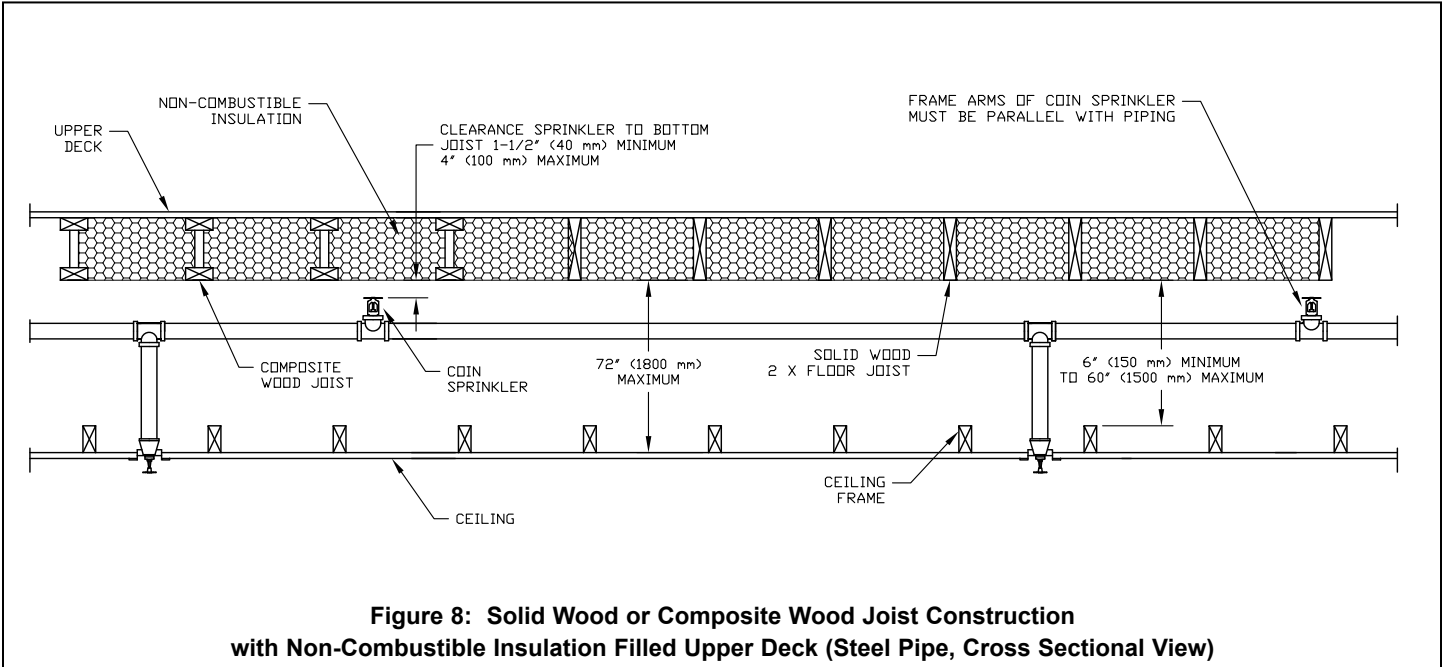

Figure 8: Solid Wood or Composite Wood Joist Construction with Non-Combustible Insulation Filled Upper Deck (Steel Pipe, Cross Sectional View)

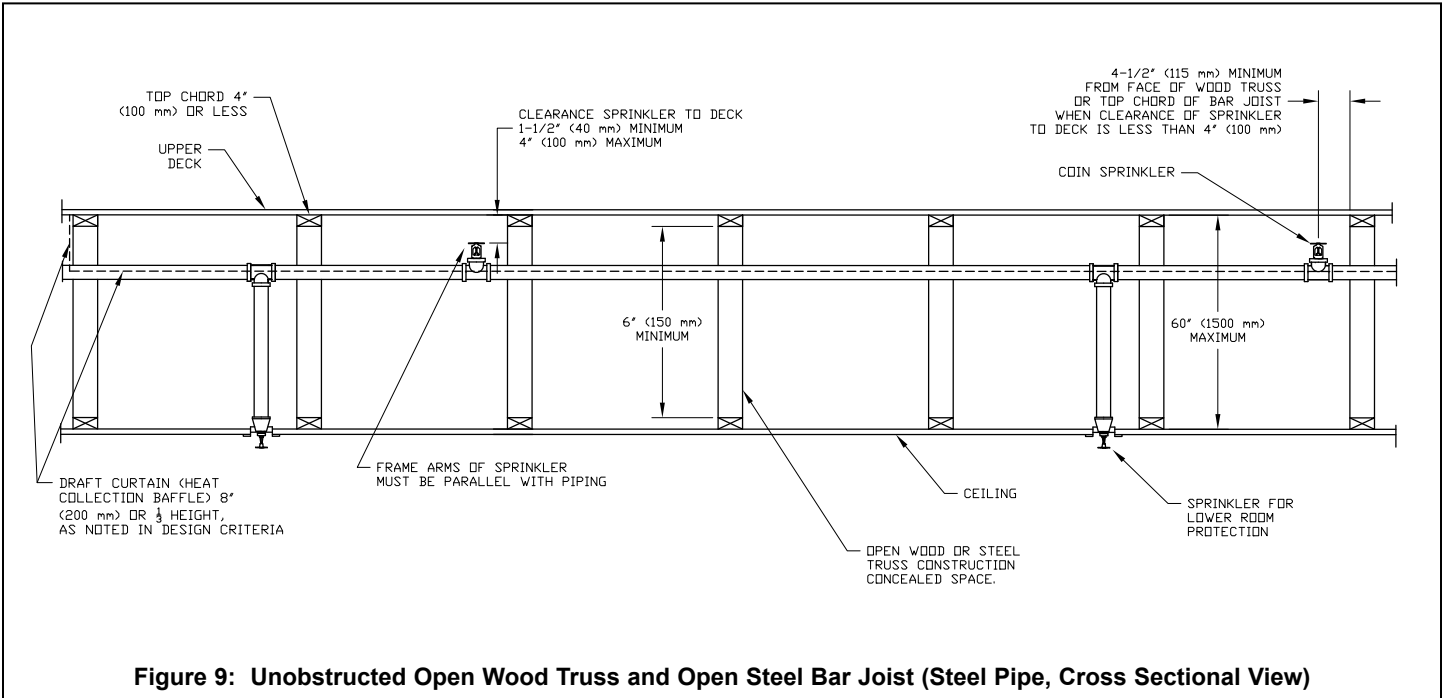

Figure 9: Unobstructed Open Wood Truss and Open Steel Bar Joist (Steel Pipe, Cross Sectional View)



TECHNICAL DATA

COIN® QUICK
RESPONSE UPRIGHT
SPRINKLER VK950
(SPECIFIC APPLICATION)

The Viking Corporation, 210 N Industrial Park Drive, Hastings MI 49058
 Telephone: 269-945-9501 Technical Services: 877-384-5464 Fax: 269-818-1680 Email: techsvcs@vikingcorp.com
 Visit the Viking website for the latest edition of this technical data page: www.vikinggroupinc.com

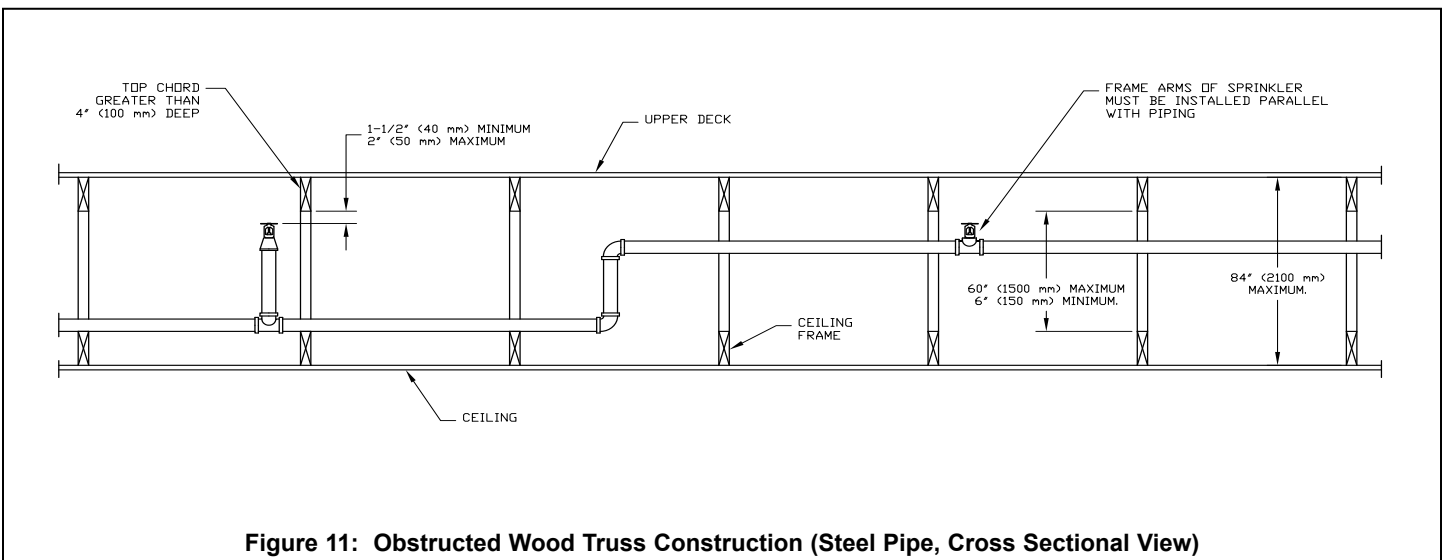
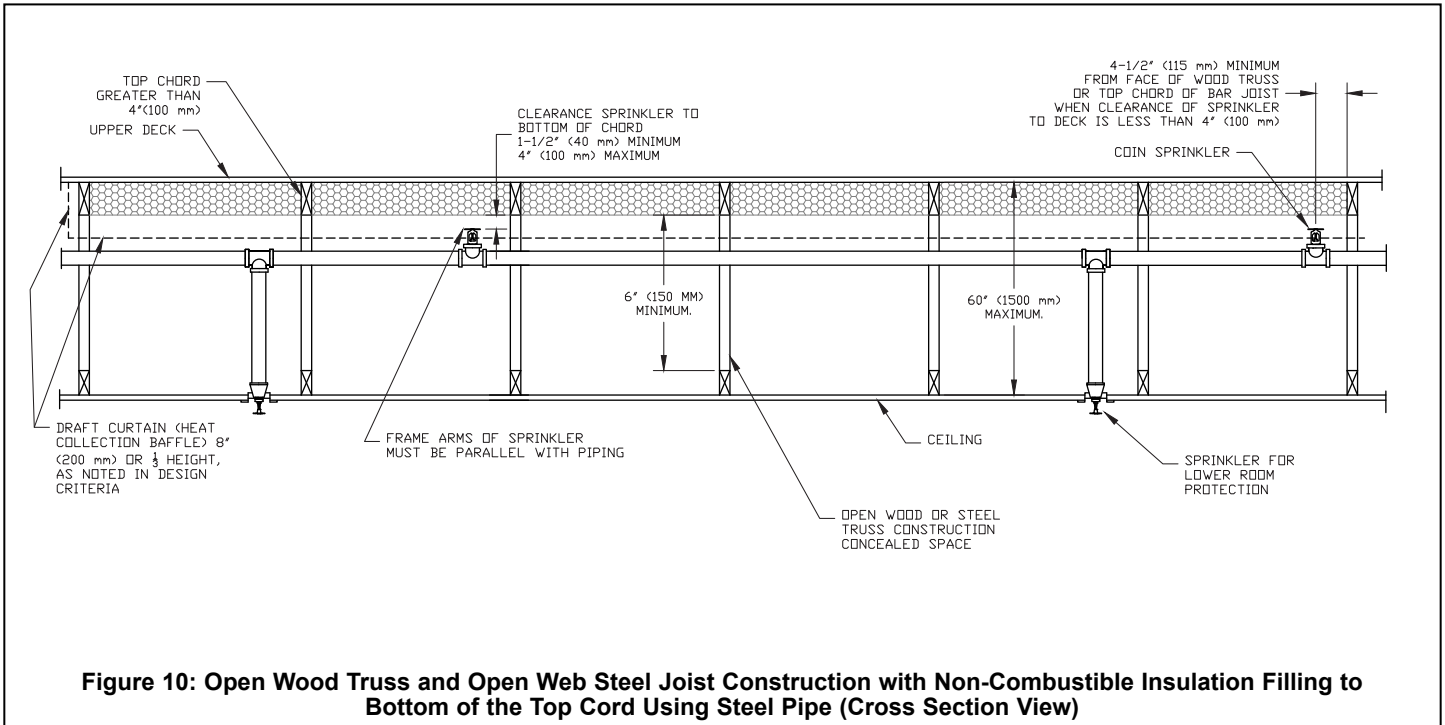



TECHNICAL DATA

**COIN® QUICK
RESPONSE UPRIGHT
SPRINKLER VK950
(SPECIFIC APPLICATION)**

The Viking Corporation, 210 N Industrial Park Drive, Hastings MI 49058
 Telephone: 269-945-9501 Technical Services: 877-384-5464 Fax: 269-818-1680 Email: techsvcs@vikingcorp.com
 Visit the Viking website for the latest edition of this technical data page: www.vikinggroupinc.com

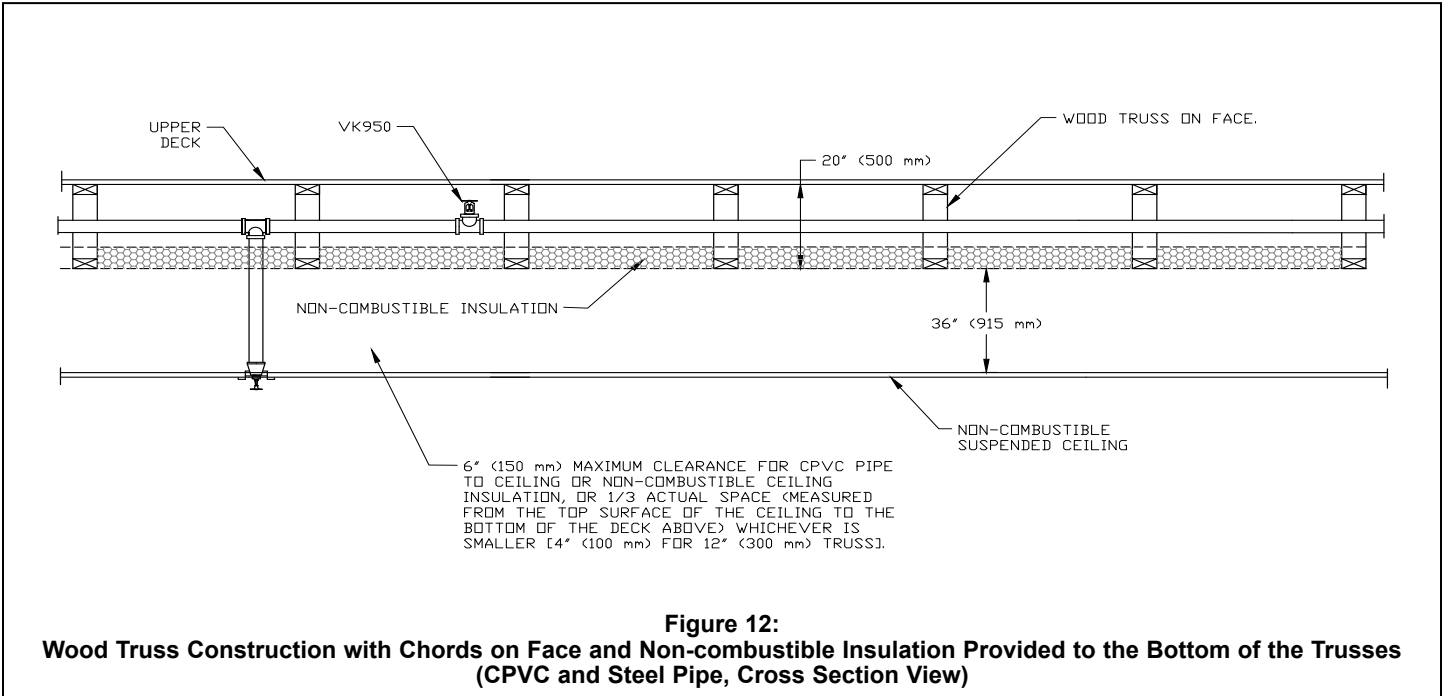



TECHNICAL DATA

COIN® QUICK
RESPONSE UPRIGHT
SPRINKLER VK950
(SPECIFIC APPLICATION)

The Viking Corporation, 210 N Industrial Park Drive, Hastings MI 49058
Telephone: 269-945-9501 Technical Services: 877-384-5464 Fax: 269-818-1680 Email: techsvcs@vikingcorp.com
Visit the Viking website for the latest edition of this technical data page: www.vikinggroupinc.com



On Face

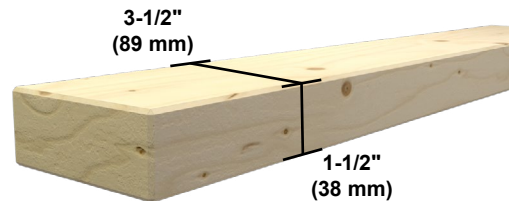

Example of Typical 2x4 Construction
Refer to Design Criteria

Figure 13A: Trusses on Face

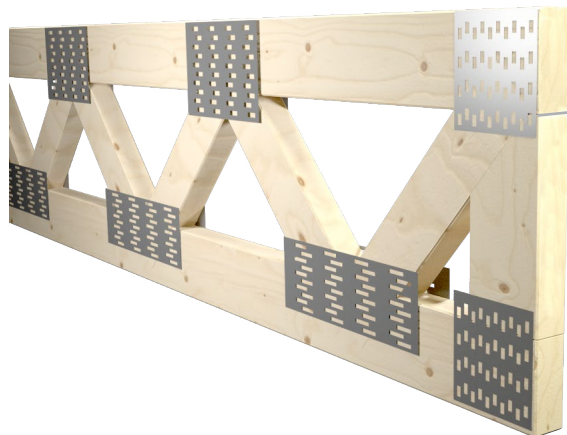

On Edge

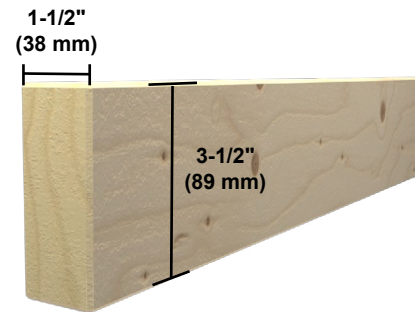

Example of Typical 2x4 Construction
Refer to Design Criteria



Figure 13B: Trusses on Edge

	<h2 style="margin: 0;">TECHNICAL DATA</h2>	<p>COIN® QUICK RESPONSE UPRIGHT SPRINKLER VK950 (SPECIFIC APPLICATION)</p>
---	--	---

The Viking Corporation, 210 N Industrial Park Drive, Hastings MI 49058
Telephone: 269-945-9501 Technical Services: 877-384-5464 Fax: 269-818-1680 Email: techsvcs@vikingcorp.com
Visit the Viking website for the latest edition of this technical data page: www.vikinggroupinc.com

OBSTRUCTION CRITERIA - CPVC and STEEL PIPE
 APPLIES TO BOTH CPVC AND STEEL PIPE (Also refer to the Approval Chart)

- OBSTRUCTIONS**
- All obstruction criteria for extended coverage sprinklers per NFPA 13 shall apply unless specified differently in this data sheet.
 - For installations where the VK950 is installed up to a 15'-0" X 15'-0" spacing or less between sprinkler, the obstruction rules for standard coverage sprinklers shall apply.
 - For installations where the VK950 exceeds 15'-0" X 15'-0" spacing, and up to 16'-0" X 16'-0" spacing, the obstruction rules for extended coverage sprinklers shall apply.
 - See illustrations below.

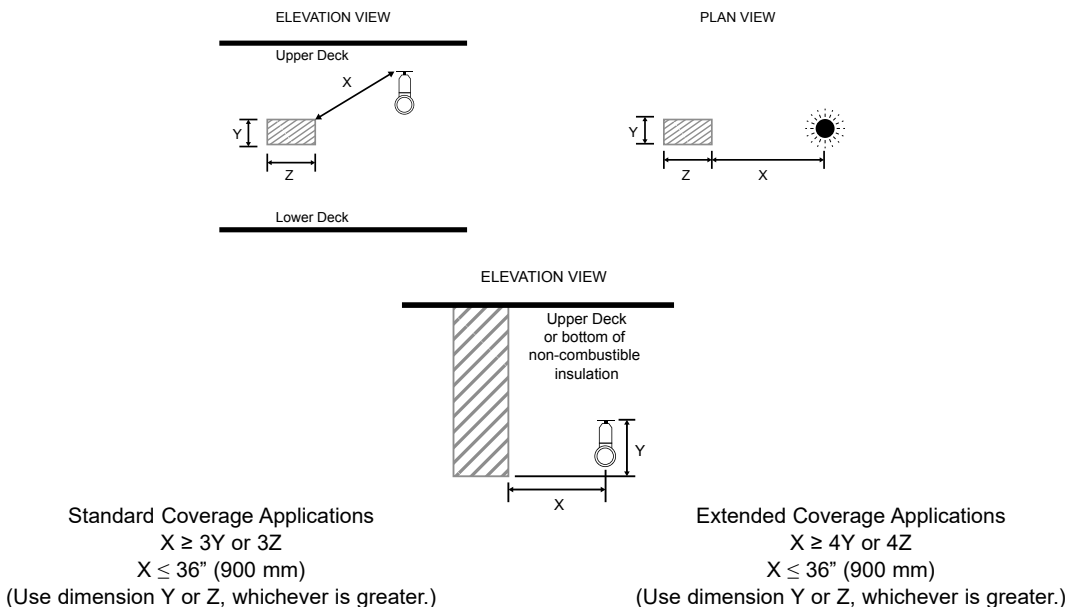

Figure 14: NFPA 13 Obstruction Criteria

NFPA 13 Obstruction Criteria - Standard Coverage Application Table 10.2.7.1.2

NFPA 13 Obstruction Criteria - Extended Coverage Application Table 11.2.5.1.2

Distance from Sprinkler to Side of Obstruction (X)		Maximum Allowable Distance of Deflector Above Bottom of Obstruction (Y)	
< 1'-0"	<300 mm	0"	0 mm
1'-0" to <1'-6"	300 mm to <450 mm	2½"	65 mm
1'-6" to <2'-0"	450 mm to <600 mm	3½"	90 mm
2'-0" to <2'-6"	600 mm to <750 mm	5½"	140 mm
2'-6" to <3'-0"	750 mm to <900 mm	7½"	190 mm
3'-0" to <3'-6"	900 mm to <1.1 m	9½"	240 mm
3'-6" to <4'-0"	1.1 m to <1.2 m	12"	300 mm
4'-0" to <4'-6"	1.2 m to <1.4 m	14"	350 mm
4'-6" to <5'-0"	1.4 m to <1.5 m	16½"	45 mm

Distance from Sprinkler to Side of Obstruction (X)		Maximum Allowable Distance of Deflector Above Bottom of Obstruction (Y)	
< 1'-0"	<300 mm	0"	0 mm
1'-0" to <1'-6"	300 mm to <450 mm	0"	0 mm
1'-6" to <2'-0"	450 mm to <600 mm	1"	25 mm
2'-0" to <2'-6"	600 mm to <750 mm	1"	25 mm
2'-6" to <3'-0"	750 mm to <900 mm	1"	75 mm
3'-0" to <3'-6"	900 mm to <1.1 m	3"	75 mm
3'-6" to <4'-0"	1.1 m to <1.2 m	3"	75 mm
4'-0" to <4'-6"	1.2 m to <1.4 m	5"	125 mm
4'-6" to <5'-0"	1.4 m to <1.5 m	7"	175 mm



TECHNICAL DATA

SPRINKLER GENERAL CARE, INSTALLATION, AND MAINTENANCE GUIDE

The Viking Corporation, 210 N Industrial Park Drive, Hastings MI 49058

Telephone: 269-945-9501 Technical Services: 877-384-5464 Fax: 269-818-1680 Email: techsvcs@vikingcorp.com

Visit the Viking website for the latest edition of this technical data page.

1. DESCRIPTION - STANDARD RESPONSE, QUICK RESPONSE, EXTENDED COVERAGE, AND DRY SPRINKLERS

Viking thermosensitive spray sprinklers consist of a small frame and either a glass bulb or a fusible operating element. Available styles include pendent, flush pendent, concealed pendent, upright, horizontal sidewall, vertical sidewall, or conventional, depending on the particular sprinkler model selected.

Viking sprinklers are available with various finishes, temperature ratings, responses, and K-Factors to meet design requirements†. Used in conjunction with one of the corrosion-resistant coatings (for frame style sprinklers), the units provide protection against many corrosive environments. In addition, the special Polyester or Teflon® coatings can be used in decorative applications where colors are desired.

† Refer to the sprinkler technical data page for available styles, finishes, temperature ratings, responses, and nominal K-Factors for specific sprinkler models.

2. LISTINGS AND APPROVALS

Refer to the Approval Charts on the appropriate sprinkler technical data page(s) and/or approval agency listings.

3. TECHNICAL DATA

Specifications:

Refer to the appropriate sprinkler technical data sheet.

Material Standards:

Refer to the appropriate sprinkler technical data sheet.

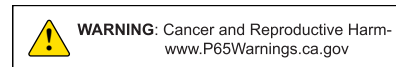

4. INSTALLATION

NOTE: Take care not to over-tighten the sprinkler and/or damage its operating parts!

Maximum Torque:

1/2" NPT: 14 ft-lbs. (19.0 N-m)

3/4" NPT: 20 ft-lbs. (27.1 N-m)

1" NPT: 30 ft-lbs. (40.7 N-m)

A. Care and Handling (also refer to Bulletin - Care and Handling of Sprinklers, Form No. F_091699.)

Sprinklers must be handled with care. They must be stored in a cool, dry place in their original shipping container. Never install sprinklers that have been dropped, damaged, or exposed to temperatures exceeding the maximum ambient temperature allowed (refer to the temperature chart on the sprinkler technical data page). Never install any glass-bulb sprinkler if the bulb is cracked or if there is a loss of liquid from the bulb. A small air bubble should be present in the glass bulb. Any sprinkler with a loss of liquid from the glass bulb or damage to the fusible element should be destroyed immediately. (Note: Installing glass bulb sprinklers in direct sunlight (ultraviolet light) may affect the color of the dye used to color code the bulb. This color change does not affect the integrity of the bulb.)

Sprinklers must be protected from mechanical damage during storage, transport, handling, and after installation. Sprinklers subject to mechanical damage must be protected with an approved sprinkler guard.

Use only sprinklers listed as corrosion resistant when subject to corrosive environments. When installing corrosion-resistant sprinklers, take care not to damage the corrosion-resistant coating. Use only the special wrench designed for installing coated or recessed Viking sprinklers (any other wrench may damage the unit).

Concealed sprinklers must be installed in neutral or negative pressure plenums only!

Use care when locating sprinklers near fixtures that can generate heat. Do not install sprinklers where they could be exposed to temperatures exceeding the maximum recommended ambient temperature for the temperature rating used.

Wet pipe systems must be provided with adequate heat. Sprinklers supplied from dry systems in areas subject to freezing must be listed dry sprinklers, upright, or horizontal sidewall sprinklers installed so that water is not trapped. For dry systems, pendent sprinklers and sidewall sprinklers installed on return bends are permitted, where the sprinklers, return bend, and branch line piping are in an area maintained at or above 40 °F (4 °C).

B. Installation Instructions - Standard Spray Sprinklers

Viking sprinklers are manufactured and tested to meet the rigid requirements of approving agencies. They are designed to be installed in accordance with recognized installation standards. Deviation from the standards or any alteration to sprinklers or cover plate assemblies after they leave the factory including, but not limited to: painting, plating, coating, or modification, may render them inoperative and will automatically nullify the approvals and any guarantee made by The Viking Corporation.



TECHNICAL DATA

SPRINKLER GENERAL CARE, INSTALLATION, AND MAINTENANCE GUIDE

The Viking Corporation, 210 N Industrial Park Drive, Hastings MI 49058

Telephone: 269-945-9501 Technical Services: 877-384-5464 Fax: 269-818-1680 Email: techsvcs@vikingcorp.com

Visit the Viking website for the latest edition of this technical data page.

Before installation, be sure to have the appropriate sprinkler model and style, with the correct K-Factor, temperature rating, and response characteristics. Sprinklers must be installed after the piping is in place to prevent mechanical damage. Keep sprinklers with protective caps or bulb shields contained within the caps or shields during installation and testing, and any time the sprinkler is shipped or handled.

1a. For frame-style sprinklers, install escutcheon (if used), which is designed to thread onto the external threads of the sprinkler. Refer to the appropriate sprinkler data page to determine approved escutcheons for use with specific sprinkler models.

1b. For flush and concealed style sprinklers: Cut the sprinkler nipple so that the 1/2" or 3/4" (15 mm or 20 mm)* NPT outlet of the reducing coupling is at the desired location, and centered in the opening* in the ceiling or wall.

*Size depends on the sprinkler model used. Refer to the sprinkler technical data page.

2. Apply a small amount of pipe-joint compound or tape to the external threads of the sprinkler only, taking care not to allow a build-up of compound in the sprinkler inlet. **NOTE:** Sprinklers with protective caps or bulb shields must have the caps or shields kept on them when applying pipe-joint compound or tape. *Exception: For domed concealed sprinklers, remove the protective cap for installation, and then place it back on the sprinkler temporarily.*

3. Refer to the appropriate sprinkler technical data page to determine the correct sprinkler wrench for the model of sprinkler used. DO NOT use the deflector or fusible element to start or thread the sprinkler into a fitting.

a. Install the sprinkler onto the piping using the special sprinkler wrench only, taking care not to over-tighten or damage the sprinkler.

b. For flush and concealed style sprinklers: the internal diameter of the special sprinkler installation wrench is designed for use with the sprinkler contained in the protective cap. *Exception: For domed concealed sprinklers, remove the protective cap for installation, and then place it back on the sprinkler temporarily.* Thread the flush or concealed sprinkler into the 1/2" or 3/4" (15 mm or 20 mm)* NPT outlet of the coupling by turning it clockwise with the special sprinkler wrench. *Thread size depends on the particular sprinkler model used. Refer to the sprinkler technical data page.

C. Installation Instructions - Dry Sprinklers

WARNING: Viking dry sprinklers are to be installed in the 1" outlet (for dry and preaction systems), or run of malleable, ductile iron, or Nibco CPVC* threaded tee fittings (for wet systems) that meet the dimensional requirements of ANSI B16.3 (Class 150), or cast iron threaded tee fittings that meet the dimensional requirements of ANSI B16.4 (Class 125), even at branch line ends. The threaded end of the dry sprinkler is designed to allow the seal to penetrate and extend into the fitting to a predetermined depth. This prevents condensation from accumulating and freezing over the sprinkler seal. ***NOTE: When using CPVC fittings with Viking dry sprinklers, use only new Nibco Model 5012-S-BI. When selecting other CPVC fittings, contact Viking Technical Services.**

1. **DO NOT** install the dry sprinkler into a threaded elbow, coupling, or any other fitting that could interfere with thread penetration. Such installation would damage the brass seal.

2. **DO NOT** install dry sprinklers into couplings or fittings that would allow condensation to accumulate above the seal when the sprinkler is located in an area subject to freezing.

3. **NEVER** try to modify dry sprinklers. They are manufactured for specific "A" or "B" dimensions and cannot be modified.

The dry sprinkler must be installed after the piping is in place to prevent mechanical damage. Before installation, be sure to have the correct sprinkler model and style, with the appropriate "A" or "B" dimension(s), temperature rating, orifice size, and response characteristics. Keep sprinklers with protective caps or bulb shields contained within the caps or shields during installation and testing, and any time the sprinkler is shipped or handled. *Exception: For concealed and adjustable recessed dry sprinklers, the protective caps and shields are removed for installation.*

To install the dry sprinkler, refer to the instructions below and the appropriate sprinkler technical data page for illustrated instructions.

Dry upright sprinklers must be installed above the piping, in the upright position only. When installing dry upright or plain barrel style vertical sidewall sprinklers on piping located close to the ceiling, it may be necessary to lower the sprinkler into the fitting from above the ceiling. When installing dry upright or plain barrel vertical sidewall sprinklers from below the ceiling, verify that the opening in the ceiling is a minimum 1-1/2" (38.1 mm) in diameter.

For dry upright or plain barrel vertical sidewall sprinklers in the upright position: First, install the escutcheon (if used) over the threaded end of the sprinkler barrel. Slide the escutcheon past the external threads. NOTE: When installing the dry upright or plain barrel vertical sidewall sprinkler from above the ceiling, it will be necessary to install the escutcheon after lowering the threaded end of the sprinkler through the ceiling penetration.

A. **For all dry sprinklers:** Apply a small amount of pipe-joint compound or tape to the external threads of the sprinkler barrel only, taking care not to allow a build-up of compound or tape over the brass inlet and seal. **NOTE:** Sprinklers with protective caps or bulb shields must be contained within the caps or shields before applying pipe-joint compound or tape.



TECHNICAL DATA

SPRINKLER GENERAL CARE, INSTALLATION, AND MAINTENANCE GUIDE

The Viking Corporation, 210 N Industrial Park Drive, Hastings MI 49058

Telephone: 269-945-9501 Technical Services: 877-384-5464 Fax: 269-818-1680 Email: techsvcs@vikingcorp.com

Visit the Viking website for the latest edition of this technical data page.

- B. Refer to the appropriate sprinkler technical data page to determine the correct sprinkler wrench for the model of sprinkler used.
- C. Install the dry sprinkler on the piping using the special dry sprinkler wrench only, while taking care not to damage the sprinkler.
NOTE: Thread the sprinkler into the fitting hand tight, plus 1/2 turn with the dry sprinkler wrench.
- D. *For adjustable standard and adjustable recessed dry pendent and sidewall sprinklers: Escutcheons can be installed after the sprinklers have been installed onto the piping. Refer to the appropriate sprinkler technical data page for escutcheon installation instructions and illustrations.*

D. Installation Instructions - Testing

- 4. After installation, the entire sprinkler system must be tested. The test must be conducted to comply with the installation standards. Viking *high pressure* sprinklers may be hydrostatically tested at a maximum of 300 psi (20.7 bar) for limited periods of time (two hours), for the purpose of acceptance by the Authority Having Jurisdiction.
 - a. Make sure the sprinkler is properly tightened. If a thread leak occurs, normally the sprinkler must be removed, new pipe-joint compound or tape applied, and then reinstalled. This is due to the fact that when the joint seal is damaged, the sealing compound or tape is washed out of the joint. Air testing [do not exceed 40 psi (2.76 bar)] the sprinkler piping prior to testing with water may be considered in areas where leakage during testing must be prevented. Refer to the Installation Standards and the Authority Having Jurisdiction.
 - b. **Remove plastic protective sprinkler caps or bulb shields AFTER the wall or ceiling finish work is completed where the sprinkler is installed and there no longer is a potential for mechanical damage to the sprinkler operating elements.** To remove the bulb shields, simply pull the ends of the shields apart where they are snapped together. To remove caps from frame style sprinklers, turn the caps slightly and pull them off the sprinklers. **SPRINKLER CAPS OR BULB SHIELDS MUST BE REMOVED FROM SPRINKLERS BEFORE PLACING THE SYSTEM IN SERVICE!** Retain a protective cap or shield in the spare sprinkler cabinet.
- 5. For flush style sprinklers: the ceiling ring can now be installed onto the sprinkler body. Align the ceiling ring with the sprinkler body and thread or push it on (depends on sprinkler model) until the outer flange touches the surface of the ceiling. Note the maximum adjustment is 1/4" (6.35 mm). DO NOT MODIFY THE UNIT. If necessary, re-cut the sprinkler drop nipple as required.
- 6. For concealed sprinklers: the cover assembly can now be attached.
 - a. Remove the cover from the protective box, taking care not to damage the cover plate assembly.
 - b. Gently place the base of the cover plate assembly over the sprinkler protruding through the opening in the ceiling.
 - c. Push the cover plate assembly onto the sprinkler until the unfinished brass flange of the cover plate base (or the cover adapter, if used) touches the surface of the ceiling.
 - d. Refer to the applicable technical data sheet to determine the maximum adjustment available for concealed sprinklers. DO NOT MODIFY THE UNIT. If necessary, re-cut the sprinkler drop nipple.

NOTE: If it is necessary to remove the entire sprinkler unit, the system must be taken out of service. See section 6. INSPECTIONS, TESTS AND MAINTENANCE and follow all warnings and instructions.

5. OPERATION

Refer to the appropriate sprinkler technical data page(s). During fire conditions, the operating element fuses or shatters (depending on the type of sprinkler), releasing the pip cap and sealing assembly. Water flowing through the sprinkler orifice strikes the sprinkler deflector, forming a uniform spray pattern to extinguish or control the fire.

IMPORTANT: Always refer to Bulletin Form No. F_091699 - Care and Handling of Sprinklers. Viking sprinklers are to be installed in accordance with the latest edition of Viking technical data, the appropriate standards of NFPA, FM Global, LPCB, APSAD, VdS or other similar organizations, and also with the provisions of governmental codes, ordinances, and standards, whenever applicable. The sprinkler technical data page may contain installation requirements specific for the sprinkler model selected. The use of certain types of sprinklers may be limited due to occupancy and hazard. Refer to the Authority Having Jurisdiction prior to installation.



TECHNICAL DATA

SPRINKLER GENERAL CARE, INSTALLATION, AND MAINTENANCE GUIDE

The Viking Corporation, 210 N Industrial Park Drive, Hastings MI 49058

Telephone: 269-945-9501 Technical Services: 877-384-5464 Fax: 269-818-1680 Email: techsvcs@vikingcorp.com

Visit the Viking website for the latest edition of this technical data page.

6. INSPECTIONS, TESTS AND MAINTENANCE

NOTICE: Refer to NFPA 25 for Inspection, Testing and Maintenance requirements. **NOTICE:** The owner is responsible for having the fire-protection system and devices inspected, tested, and maintained in proper operating condition in accordance with this guide, and applicable NFPA standards. In addition, the Authority Having Jurisdiction may have additional maintenance, testing, and inspection requirements that must be followed.

- A. Sprinklers must be inspected on a regular basis for corrosion, mechanical damage, obstructions, paint, etc. Frequency of inspections may vary due to corrosive atmospheres, water supplies, and activity around the sprinkler unit.
- B. Sprinklers or cover plate assemblies that have been field painted, caulked, or mechanically damaged must be replaced immediately. Sprinklers showing signs of corrosion shall be tested and/or replaced immediately as required. Installation standards require sprinklers to be tested and, if necessary, replaced after a specified term of service. Refer to NFPA 25 and the Authority Having Jurisdiction for the specified period of time after which testing and/or replacement is required. Never attempt to repair or reassemble a sprinkler. Sprinklers and cover assemblies that have operated cannot be reassembled or re-used, but must be replaced. When replacement is necessary, use only new sprinklers and cover assemblies with identical performance characteristics.
- C. The sprinkler discharge pattern is critical for proper fire protection. Therefore, nothing should be hung from, attached to, or otherwise obstruct the discharge pattern. All obstructions must be immediately removed or, if necessary, additional sprinklers installed.
- D. When replacing existing sprinklers, the system must be removed from service. Refer to the appropriate system description and/or valve instructions. Prior to removing the system from service, notify all Authorities Having Jurisdiction. Consideration should be given to employment of a fire patrol in the affected area.
 1. Remove the system from service, drain all water, and relieve all pressure on the piping.
 - 2a. For frame-style sprinklers, use the special sprinkler wrench to remove the old sprinkler by turning it counterclockwise to unthread it from the piping.
 - 2b. For flush and concealed style sprinklers: Remove the ceiling ring or cover plate assembly before unthreading the sprinkler body from the piping. Ceiling rings and cover plates can be removed either by gently unthreading them or pulling them off the sprinkler body (depends on the sprinkler model used). After the ceiling ring or cover plate assembly has been removed from the sprinkler body, place the plastic protective cap (from the spare sprinkler cabinet) over the sprinkler to be removed and then fit the sprinkler wrench over the cap. Then use the wrench to unthread the sprinkler from the piping. *Exception: Domed concealed sprinklers are removed without the plastic cap.*
 3. Install the new sprinkler unit by following the instructions in section 4. INSTALLATION. Care must be taken to ensure that the replacement sprinkler is the proper model and style, with the correct K-Factor, temperature rating, and response characteristics. A fully stocked spare sprinkler cabinet should be provided for this purpose. For flush or concealed sprinklers: stock of spare ceiling rings or cover plates should also be available in the spare sprinkler cabinet.
- E. Place the system back in service and secure all valves. Check for and repair all leaks. Sprinkler systems that have been subjected to a fire must be returned to service as soon as possible. The entire system must be inspected for damage, and repaired or replaced as necessary. Sprinklers that have been exposed to corrosive products of combustion or high ambient temperatures, but have not operated, should be replaced. Refer to the Authority Having Jurisdiction for minimum replacement requirements.

7. AVAILABILITY

Viking sprinklers are available through a network of domestic and international distributors. See The Viking Corporation web site for the closest distributor or contact The Viking Corporation.

8. GUARANTEE

For details of warranty, refer to Viking's current list price schedule or contact Viking directly.



TECHNICAL DATA

SPRINKLER OVERVIEW

The Viking Corporation, 210 N Industrial Park Drive, Hastings MI 49058

Telephone: 269-945-9501 Technical Services: 877-384-5464 Fax: 269-818-1680 Email: techsvcs@vikingcorp.com

1. DESCRIPTION

Viking fire sprinklers consist of a threaded frame with a specific waterway or orifice size and a deflector for distributing water in a specified pattern. A closed or sealed sprinkler refers to a complete assembly, including the thermosensitive operating element. An open sprinkler does not use an operating element and is open at all times. The distribution of water is intended to extinguish a fire or to control its spread.

Viking sprinklers are available in several models and styles. Refer to specific sprinkler technical data pages for available styles, finishes, temperature ratings, thread sizes, and nominal K-Factors for the particular model selected.

2. LISTINGS AND APPROVALS

Refer to the Approval Charts on the appropriate sprinkler technical data page(s) and/or approval agency listings.



WARNING: Cancer and Reproductive Harm-
www.P65Warnings.ca.gov

3. TECHNICAL DATA

Pressure Ratings:

Maximum allowable water working pressure is 175 psig (12 Bar) unless rated and specified for high water working pressure [250 psig (17.2 bar)].

Sprinkler Identification:

Viking sprinklers are identified and marked with the word "Viking", the sprinkler identification number (SIN) consisting of "VK" plus a three digit number*, the model letter, and the year of manufacture.

Available Finishes:

Viking sprinklers are available in several decorative finishes. Some models are available with corrosion-resistant coatings or are fabricated from non-corrosive material. Refer to the sprinkler technical data page for additional information.

Available Temperature Ratings:

Viking sprinklers are available in several temperature ratings that relate to a specific temperature classification. Applicable installation rules mandate the use and limitations of each temperature classification. In selecting the appropriate temperature classification, the maximum expected ceiling temperature must be known. When there is doubt as to the maximum temperature at the sprinkler location, a maximum-reading thermometer should be used to determine the temperature under conditions that would show the highest readings to be expected. In addition, recognized installation rules may require a higher temperature classification, depending upon sprinkler location, occupancy classification, commodity classification, storage height, and other hazards. In all cases, the maximum expected ceiling temperature dictates the lowest allowable temperature classification. Sprinklers located immediately adjacent to a heat source may require a higher temperature rating.

K-Factors:

Viking sprinklers are available in several orifice sizes with related K-Factors. The orifice is a tapered waterway and, therefore, the K-Factor given is nominal. Nominal U.S. K-Factors are provided in accordance with the 1999 edition of NFPA 13, Section 3-2.3. Refer to the specific data page for appropriate K-Factor information.

Available Styles:

Viking sprinklers are available for installation in several positions as indicated by a stamping on the deflector. The deflector style dictates the appropriate installation position of the sprinkler; it breaks the solid stream of water issuing from the sprinkler orifice to form a specific spray pattern. The following list indicates the various styles and identification of Viking sprinklers.

UPRIGHT SPRINKLER: A sprinkler intended to be installed with the deflector above the frame so water flows upward through the orifice, striking the deflector and forming an umbrella-shaped spray pattern downward. Marked "SSU" (Standard Sprinkler Upright) or "UPRIGHT" on the deflector.

PENDENT SPRINKLER: A sprinkler intended to be oriented with the deflector below the frame so water flows downward through the orifice, striking the deflector and forming an umbrella-shaped spray pattern downward. Marked "SSP" (Standard Sprinkler Pendent) or "PENDENT" on the deflector.

CONVENTIONAL SPRINKLER: An "old style" sprinkler intended to be installed with the deflector in either the upright or pendent position. The deflector provides a spherical type pattern with 40 to 60 percent of the water initially directed downward and a proportion directed upward. Must be installed in accordance with installation rules for conventional or old style sprinklers. **DO NOT USE AS A REPLACEMENT FOR STANDARD SPRAY SPRINKLERS.** Marked "C U/P" (Conventional Upright/Pendent) on the deflector.

Viking Technical Data may be found on
The Viking Corporation's Web site at
<http://www.vikinggroupinc.com>.
The Web site may include a more recent
edition of this Technical Data Page.



TECHNICAL DATA

SPRINKLER OVERVIEW

The Viking Corporation, 210 N Industrial Park Drive, Hastings MI 49058

Telephone: 269-945-9501 Technical Services: 877-384-5464 Fax: 269-818-1680 Email: techsvcs@vikingcorp.com

VERTICAL SIDEWALL (VSW) SPRINKLER: A sprinkler intended for installation near the wall and ceiling. The deflector provides a water spray pattern outward in a quarter-spherical pattern and can be installed in the upright or pendent position with the flow arrow in the direction of discharge. Marked "SIDEWALL" on the deflector with an arrow and the word "FLOW". (Note: Some vertical sidewall sprinklers can only be installed in the upright or pendent position—in this case, the sprinkler will also be marked "UPRIGHT" or "PENDENT".)

HORIZONTAL SIDEWALL (HSW) SPRINKLER: A sprinkler intended for installation near the wall and ceiling. The special deflector provides a water spray pattern outward in a quarter-spherical pattern. Most of the water is directed away from the nearby wall with a small portion directed at the wall behind the sprinkler. The top of the deflector is oriented parallel with the ceiling or roof. The flow arrows point in the direction of discharge. Marked "SIDEWALL" and "TOP" with an arrow and the word "FLOW".

EXTENDED COVERAGE (EC) SPRINKLER: A spray sprinkler designed to discharge water over an area having the maximum dimensions indicated in the individual listings. Maximum area of coverage, minimum flow rate, orifice size, and nominal K-Factor are specified in the individual listings. EC sprinklers are intended for Light-Hazard occupancies with smooth, flat, horizontal ceilings unless otherwise specified. In addition to the above markings, the sprinkler is marked "EC".

QUICK RESPONSE (QR) SPRINKLER: A spray sprinkler with a fast-actuating operating element. The use of quick response sprinklers may be limited due to occupancy and hazard. Refer to the Authority Having Jurisdiction (AHJ) prior to installing.

QUICK RESPONSE EXTENDED COVERAGE (QREC) SPRINKLER: A spray sprinkler designed to discharge water over an area having the maximum dimensions indicated in the individual listing. This is a sprinkler with an operating element that meets the criteria for quick response. QREC sprinklers are only intended for Light Hazard occupancies. The sprinkler is marked "QREC".

FLUSH SPRINKLER: A decorative spray sprinkler intended for installation with a concealed piping system. The unit is mounted flush with the ceiling or wall, with the fusible link exposed. Upon actuation, the deflector extends beyond the ceiling or wall to distribute water discharge. The sprinkler is marked "SSP", "PEND", or "SIDEWALL" and "TOP".

CONCEALED SPRINKLER: A decorative spray sprinkler intended for installation with a concealed piping system. The sprinkler is hidden from view by a cover plate installed flush with the ceiling or wall. During fire conditions, the cover plate detaches, and upon sprinkler actuation, the deflector extends beyond the ceiling or wall to distribute water discharge. The sprinkler is marked "SSP", "PEND", or "SIDEWALL" and "TOP".

RECESSED SPRINKLER: A spray sprinkler assembly intended for installation with a concealed piping system. The assembly consists of a sprinkler installed in a decorative adjustable recessed escutcheon that minimizes the protrusion of the sprinkler beyond the ceiling or wall without adversely affecting the sprinkler distribution or sensitivity. Refer to the appropriate technical data page for allowable sprinkler models, temperature ratings, and occupancy classifications. DO NOT RECESS ANY SPRINKLER NOT LISTED FOR USE WITH THE ESCUTCHEON.

CORROSION-RESISTANT SPRINKLER: A special service sprinkler with non-corrosive protective coatings, or that is fabricated from non-corrosive material, for use in atmospheres that would normally corrode sprinklers.

DRY SPRINKLER: A special-service sprinkler intended for installation on dry pipe systems or wet pipe systems where the sprinkler is subject to freezing temperatures. The unit consists of a sprinkler permanently secured to an extension nipple with a sealed inlet end to prevent water from entering the nipple until the sprinkler operates. The unit MUST be installed in a tee fitting. Dry upright sprinklers are marked with the "B" dimension [distance from the face of the fitting (tee) to the top of the deflector]. Dry pendent and sidewall sprinklers are marked with the "A" dimension [the distance from the face of fitting (tee) to the finished surface of the ceiling or wall].

LARGE DROP SPRINKLER: A type of special application sprinkler used to provide fire control of specific high-challenge fire hazards. Large drop sprinklers are designed to produce an umbrella-shaped spray pattern downward with a higher percentage of "large" water droplets than standard spray sprinklers. The sprinkler has an extra-large orifice with a nominal K-Factor of 11.2. Marked "HIGH CHALLENGE" and "UPRIGHT".

EARLY SUPPRESSION FAST-RESPONSE (ESFR) SPRINKLER: A sprinkler intended to provide fire suppression of specific high-challenge fire hazards through the use of a fast response fusible link, 14.0, 16.8, or 25.2 nominal K-Factor, and special deflector. ESFR sprinklers are designed to produce high-momentum water droplets in a hemispherical pattern below the deflector. This permits penetration of the fire plume and direct wetting of the burning fuel surface while cooling the atmosphere early in the development of a high-challenge fire. Marked "ESFR" and "UPRIGHT" or "PEND".

INTERMEDIATE LEVEL/RACK STORAGE SPRINKLER: A standard spray sprinkler assembly designed to protect its operating element from the spray of sprinklers installed at higher elevations. The assembly consists of a standard or large orifice upright or pendent sprinkler with an integral upright or pendent water shield and guard assembly. Use only those sprinklers that have been tested and listed for use with the assembly. Refer to the technical data page for allowable sprinkler models.

RESIDENTIAL SPRINKLER: A sprinkler intended for use in the following occupancies: one- and two-family dwellings with the fire protection sprinkler system installed in accordance with NFPA 13D; residential occupancies up to four stories in height with the fire protection system installed in accordance with NFPA 13R; and where allowed by the Authority Having Jurisdiction in residential portions of any occupancy with the fire protection system installed in accordance with NFPA 13.



TECHNICAL DATA

SPRINKLER OVERVIEW

The Viking Corporation, 210 N Industrial Park Drive, Hastings MI 49058

Telephone: 269-945-9501 Technical Services: 877-384-5464 Fax: 269-818-1680 Email: techsvcs@vikingcorp.com

Residential sprinklers have a unique distribution pattern and utilize a “fast response” heat sensitive operating element. They enhance survivability in the room of fire origin and are designed to provide a life safety environment for a minimum of ten minutes. For this reason, residential sprinklers must not be used to replace standard sprinklers unless tested for and approved by the Authority Having Jurisdiction. In addition to standard markings, the unit is identified as “RESIDENTIAL SPRINKLER” or “RES”.

4. INSTALLATION

Refer to appropriate NFPA Installation Standards.

5. OPERATION

Refer to the appropriate sprinkler technical data page(s).

6. INSPECTIONS, TESTS AND MAINTENANCE

Refer to NFPA 25 for Inspection, Testing and Maintenance requirements.

7. AVAILABILITY

Viking sprinklers are available through a network of domestic and international distributors. See The Viking Corporation web site for the closest distributor or contact The Viking Corporation.

8. GUARANTEE

For details of warranty, refer to Viking’s current list price schedule or contact Viking directly.

IMPORTANT: Always refer to Bulletin Form No. F_091699 - Care and Handling of Sprinklers and the appropriate sprinkler general care, installation, and maintenance guide. Vikings sprinklers are to be installed in accordance with the latest edition of Viking technical data, the appropriate standards of NFPA, FM Global, LPCB, APSAD, VdS or other similar organizations, and also with the provisions of governmental codes, ordinances, and standards, whenever applicable. The sprinkler technical data page may contain installation requirements specific for the sprinkler model selected. The use of certain types of sprinklers may be limited due to occupancy and hazard. Refer to the Authority Having Jurisdiction prior to installation.



BULLETIN

CARE AND HANDLING OF SPRINKLERS

The Viking Corporation, 210 N Industrial Park Drive, Hastings MI 49058
 Telephone: 269-945-9501 Technical Services: 877-384-5464 Fax: 269-818-1680 Email: techsvcs@vikingcorp.com

SPRINKLERS ARE FRAGILE - HANDLE WITH CARE!

General Handling and Storage:

- Store sprinklers in a cool, dry place.
- Protect sprinklers during storage, transport, handling, and after installation.
- Use the original shipping containers. DO NOT place sprinklers loose in boxes, bins, or buckets.
- Keep sprinklers separated at all times. DO NOT allow metal parts to contact sprinkler operating elements.

For Pre-Assembled Drops:

- Protect sprinklers during handling and after installation.
- For recessed assemblies, use the protective sprinkler cap (Viking Part Number 10364).

Sprinklers with Protective Shields or Caps:

- DO NOT remove shields or caps until after sprinkler installation and there no longer is potential for mechanical damage to the sprinkler operating elements.
- **Sprinkler shields or caps MUST be removed BEFORE placing the system in service!**
- Remove the sprinkler shield by carefully pulling it apart where it is snapped together.
- Remove the cap by turning it slightly and pulling it off the sprinkler.

Sprinkler Installation:

- DO NOT use the sprinkler deflector or operating element to start or thread the sprinkler into a fitting.
- **Use only the designated sprinkler head wrench!** Refer to the current sprinkler technical data page to determine the correct wrench for the model of sprinkler used.
- DO NOT install sprinklers onto piping at the floor level.
- Install sprinklers after the piping is in place to prevent mechanical damage.
- DO NOT allow impacts such as hammer blows directly to sprinklers or to fittings, pipe, or couplings in close proximity to sprinklers. Sprinklers can be damaged from direct or indirect impacts.
- DO NOT attempt to remove drywall, paint, etc., from sprinklers.
- **Take care not to over-tighten the sprinkler and/or damage its operating parts!**

Maximum Torque:

- 1/2" NPT: 14 ft-lbs. (19.0 N-m)
- 3/4" NPT: 20 ft-lbs. (27.1 N-m)
- 1" NPT: 30 ft-lbs. (40.7 N-m)



CORRECT
(Original container used)

INCORRECT
(Placed loose in box)

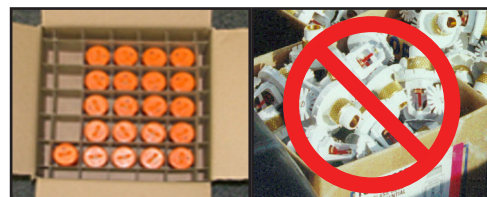

CORRECT
(Protected with caps)

INCORRECT
(Protective caps not used)



CORRECT
(Piping is in place at the ceiling)

INCORRECT
(Sprinkler at floor level)



CORRECT
(Special installation wrenches)

INCORRECT
(Designated wrench not used)

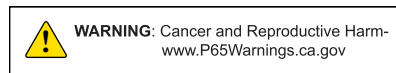

! WARNING

Any sprinkler with a loss of liquid from the glass bulb or damage to the fusible element should be destroyed. Never install sprinklers that have been dropped, damaged, or exposed to temperatures exceeding the maximum ambient temperature allowed. Sprinklers that have been painted in the field must be replaced per NFPA 13. Protect sprinklers from paint and paint overspray in accordance with the installation standards. Do not clean sprinklers with soap and water, ammonia, or any other cleaning fluid. Do not use adhesives or solvents on sprinklers or their operating elements.

Refer to the appropriate technical data page and NFPA standards for complete care, handling, installation, and maintenance instructions. For additional product and system information Viking data pages and installation instructions are available on the Viking Web site at www.vikinggroupinc.com.



BULLETIN

CARE AND HANDLING
OF SPRINKLERS

The Viking Corporation, 210 N Industrial Park Drive, Hastings MI 49058
 Telephone: 269-945-9501 Technical Services: 877-384-5464 Fax: 269-818-1680 Email: techsvcs@vikingcorp.com

PROTECTIVE SPRINKLER SHIELDS AND CAPS

General Handling and Storage:

Many Viking sprinklers are available with a plastic protective cap or shield temporarily covering the operating elements. The snap-on shields and caps are factory installed and are intended to help protect the operating elements from mechanical damage during shipping, storage, and installation. NOTE: It is still necessary to follow the care and handling instructions on the appropriate sprinkler technical data sheets* when installing sprinklers with bulb shields or caps.

WHEN TO REMOVE THE SHIELDS AND CAPS:

NOTE: SHIELDS AND CAPS MUST BE REMOVED FROM SPRINKLERS BEFORE PLACING THE SYSTEM IN SERVICE!

Remove the shield or cap from the sprinkler only after checking all of the following:

- The sprinkler has been installed*.
- The wall or ceiling finish work is completed where the sprinkler is installed and there no longer is a potential for mechanical damage to the sprinkler operating elements.

SHIELDS AND CAPS MUST BE REMOVED FROM SPRINKLERS BEFORE PLACING THE SYSTEM IN SERVICE!



Figure 1: Sprinkler shield being removed from a pendent sprinkler.



Figure 2: Sprinkler cap being removed from a pendent sprinkler.



Figure 3: Sprinkler cap being removed from an upright sprinkler.

HOW TO REMOVE SHIELDS AND CAPS:

No tools are necessary to remove the shields or caps from sprinklers. DO NOT use any sharp objects to remove them! **Take care not to cause mechanical damage to sprinklers when removing the shields or caps.** When removing caps from fusible element sprinklers, use care to prevent dislodging ejector springs or damaging fusible elements. NOTE: Squeezing the sprinkler cap excessively could damage sprinkler fusible elements.

- To remove the shield, simply pull the ends of the shield apart where it is snapped together. Refer to Figure 1.
- To remove the cap, turn it slightly and pull it off the sprinkler. Refer to Figures 2 and 3.

NOTICE

Refer to the current sprinkler technical data page to determine the correct sprinkler wrench for the model of sprinkler used.

WARNING

Never install sprinklers that have been dropped, damaged, or exposed to temperatures in excess of the maximum ambient temperature allowed.

* Refer to the appropriate current technical data pages for complete care, handling, and installation instructions. Data pages are included with each shipment from Viking or Viking distributors. They can also be found on the Web site at www.vikinggroupinc.com.



BULLETIN

CARE AND HANDLING
OF SPRINKLERS

The Viking Corporation, 210 N Industrial Park Drive, Hastings MI 49058
 Telephone: 269-945-9501 Technical Services: 877-384-5464 Fax: 269-818-1680 Email: techsvcs@vikingcorp.com



CONCEALED COVER ASSEMBLIES ARE FRAGILE!
TO ASSURE SATISFACTORY PERFORMANCE OF THE PRODUCT, HANDLE WITH CARE.

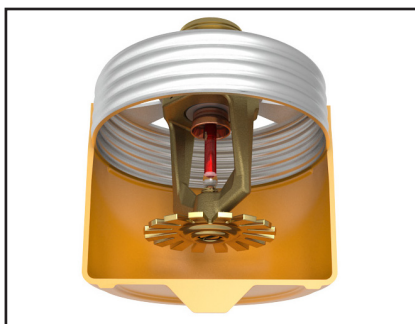

Concealed Sprinkler and Adapter
 Assembly with Protective Cap

Concealed Sprinkler and Adapter
 Assembly (Protective Cap Removed)



Cover Plate Assembly
 (Pendent Cover 12381 shown)



GENERAL HANDLING AND STORAGE INSTRUCTIONS:

- Do not store in temperatures exceeding 100 °F (38 °C). Avoid direct sunlight and confined areas subject to heat.
- Protect sprinklers and cover assemblies during storage, transport, handling, and after installation.
 - Use original shipping containers.
 - Do not place sprinklers or cover assemblies loose in boxes, bins, or buckets.
- Keep the sprinkler bodies covered with the protective sprinkler cap any time the sprinklers are shipped or handled, during testing of the system, and while ceiling finish work is being completed.
- Use only the designated Viking recessed sprinkler wrench (refer to the appropriate sprinkler data page) to install these sprinklers. **NOTE:** The protective cap is temporarily removed during installation and then placed back on the sprinkler for protection until finish work is completed.
- Do not over-tighten the sprinklers into fittings during installation.
- Do not use the sprinkler deflector to start or thread the sprinklers into fittings during installation.
- Do not attempt to remove drywall, paint, etc., from the sprinklers.
- Remove the plastic protective cap from the sprinkler before attaching the cover plate assembly. **PROTECTIVE CAPS MUST BE REMOVED FROM SPRINKLERS BEFORE PLACING THE SYSTEM IN SERVICE!**

Refer to the appropriate current technical data pages for complete care, handling, and installation instructions. Data pages are included with each shipment from Viking or Viking distributors. They can also be found on the Web site at www.vikinggroupinc.com.



BULLETIN

CARE AND HANDLING
OF SPRINKLERS

The Viking Corporation, 210 N Industrial Park Drive, Hastings MI 49058

Telephone: 269-945-9501 Technical Services: 877-384-5464 Fax: 269-818-1680 Email: techsvcs@vikingcorp.com

USE THE FOLLOWING PRECAUTIONS WHEN HANDLING WAX-COATED SPRINKLERS

Many of Viking's sprinklers are available with factory-applied wax coating for corrosion resistance. These sprinklers MUST receive appropriate care and handling to avoid damaging the wax coating and to assure satisfactory performance of the product.

General Handling and Storage of Wax-Coated Sprinklers:

- Store the sprinklers in a cool, dry place (in temperatures below the maximum ambient temperature allowed for the sprinkler temperature rating. Refer to Table 1 below.)
- Store containers of wax-coated sprinklers separate from other sprinklers.
- Protect the sprinklers during storage, transport, handling, and after installation.
- Use original shipping containers.
- Do not place sprinklers in loose boxes, bins, or buckets.

Installation of Wax-Coated Sprinklers:

Use only the special sprinkler head wrench designed for installing wax-coated Viking sprinklers (any other wrench may damage the unit).

- Take care not to crack the wax coating on the units.
- For touching up the wax coating after installation, wax is available from Viking in bar form. Refer to Table 1 below. The coating MUST be repaired after sprinkler installation to protect the corrosion-resistant properties of the sprinkler.
- Use care when locating sprinklers near fixtures that can generate heat. Do not install sprinklers where they would be exposed to temperatures exceeding the maximum recommended ambient temperature for the temperature rating used.
- Inspect the coated sprinklers frequently soon after installation to verify the integrity of the corrosion resistant coating. Thereafter, inspect representative samples of the coated sprinklers in accordance with NFPA 25. Close up visual inspections are necessary to determine whether the sprinklers are being affected by corrosive conditions.

TABLE 1

Sprinkler Temperature Rating (Fusing Point)	Wax Part Number	Wax Melting Point	Maximum Ambient Ceiling Temperature ¹	Wax Color
155 °F (68 °C) / 165 °F (74 °C)	02568A	148 °F (64 °C)	100 °F (38 °C)	Light Brown
175 °F (79 °C)	04146A	161 °F (71 °C)	150 °F (65 °C)	Brown
200 °F (93 °C)	04146A	161 °F (71 °C)	150 °F (65 °C)	Brown
220 °F (104 °C)	02569A	170 °F (76 °C)	150 °F (65 °C)	Dark Brown
286 °F (141 °C)	02569A	170 °F (76 °C)	150 °F (65 °C)	Dark Brown

¹ Based on NFPA-13. Other limits may apply, depending on fire loading, sprinkler location, and other requirements of the Authority Having Jurisdiction. Refer to specific installation standards.



Never install sprinklers that have been dropped, damaged, or exposed to temperatures in excess of the maximum ambient temperature allowed.

Refer to the appropriate current technical data pages for complete care, handling, and installation instructions. Data pages are included with each shipment from Viking or Viking distributors. They can also be found on the Web site at www.vikinggroupinc.com.

**BULLETIN****REGULATORY AND HEALTH
WARNINGS**

The Viking Corporation, 210 N Industrial Park Drive, Hastings MI 49058

Telephone: 269-945-9501 Technical Services: 877-384-5464 Fax: 269-818-1680 Email: techsvcs@vikingcorp.com

Visit the Viking website for the latest edition of this technical data page www.vikinggroupinc.com

1. DESCRIPTION

Regulatory and Health Warnings applying to materials used in the manufacture and construction of fire protection products are provided herein as they relate to legally mandated jurisdictional regions.

⚠ WARNING**STATE OF CALIFORNIA, USA**

Installing or servicing fire protection products such as sprinklers, valves, piping etc. can expose you to chemicals including, but not limited to, lead, nickel, butadiene, titanium dioxide, chromium, carbon black, and acrylonitrile which are known to the State of California to cause cancer or birth defects or other reproductive harm.

For more information, go to www.P65Warnings.ca.gov

2. WARRANTY TERMS AND CONDITIONS

For details of warranty, refer to Viking's current list price schedule at www.vikinggroupinc.com or contact Viking directly.